

ISSN: 2718-2177

International Conference  
**S+M(L)=KI**<sup>15</sup>

22<sup>nd</sup> and  
23<sup>rd</sup>  
February  
2024

# XV Meeting of Young Chemical Engineers

[www.fkit.unizg.hr/smlki](http://www.fkit.unizg.hr/smlki)

Faculty of  
Chemical  
Engineering and  
Technology  
Zagreb

Croatian  
Society of  
Chemical  
Engineers

 **EuChemS**  
European Chemical Society

## BOOK OF ABSTRACTS Knjiga sažetaka

Zagreb, Croatia, 22<sup>nd</sup> and 23<sup>rd</sup> February 2024



HRVATSKO DRUŠTVO KEMIJSKIH INŽENJERA I TEHNOLOGA

SVEUČILIŠTE U ZAGREBU

FAKULTET KEMIJSKOG INŽENJERSTVA I TEHNOLOGIJE

**XV. SUSRET MLADIH KEMIJSKIH  
INŽENJERA  
KNJIGA SAŽETAKA**

*XV MEETING OF YOUNG CHEMICAL ENGINEERS  
BOOK OF ABSTRACTS*

Zagreb, 22. i 23. veljače 2024.

*Zagreb, 22<sup>nd</sup> and 23<sup>rd</sup> February 2024*

**Izdavač / *Published by***

Hrvatsko društvo kemijskih inženjera i tehnologa  
*Croatian Society of Chemical Engineers*

**Za izdavača / *For the publisher***

Tomislav Bolanča

**Urednici / *Editors***

Željka Ujević Andrijić, Andrej Vidak

**Grafički urednik / *Graphical editor***

Zdenko Blažeković

**Recenzenti / *Reviewers***

Marin Kovačić  
Dajana Kučić Grgić  
Ana Petračić  
Marko Sejdić  
Monika Šabić Runjavec  
Anita Šalić  
Željka Ujević Andrijić  
Andrej Vidak  
Krunoslav Žižek  
Andreja Žužić  
  
Stevo Lavrnić  
Albin Pintar  
Elena Simone

**Tekst pripremili / *Text prepared by***

AUTORI, koji su odgovorni za tekst sažetaka  
*AUTHORS, who are fully responsible for the abstracts*

**Priprema / *Layout***

Željka Ujević Andrijić, Zdenko Blažeković

ISSN 2718-2177

**Organizatori / Organizers**

Hrvatsko društvo kemijskih inženjera i tehnologa / *Croatian Society of Chemical Engineers*  
Sveučilište u Zagrebu Fakultet kemijskog inženjerstva i tehnologije / *University of Zagreb Faculty of Chemical Engineering and Technology*

**Pokrovitelji / Under the Auspices of the**

Ministarstvo znanosti i obrazovanja / *Ministry of Science and Education*  
Sveučilište u Zagrebu / *University of Zagreb*  
Akademija tehničkih znanosti Hrvatske / *Croatian Academy of Engineering*  
Hrvatski inženjerski savez / *Croatian Engineering Association*

**Znanstveno-organizacijski odbor / Scientific and Organizing Committee**

Željka Ujević Andrijić, predsjednica / *Chair*  
Andreja Žužić, organizacijska tajnica / *Secretarie*  
Marin Kovačić  
Dajana Kučić Grgić  
Ana Petračić  
Marko Sejdić  
Monika Šabić Runjavec  
Anita Šalić  
Lara Štorga  
Andrej Vidak  
Krunoslav Žižek

**Inozemni članovi / International Members of the Committee**

Stevo Lavrnić (ITA)  
Albin Pintar (SLO)  
Elena Simone (ITA)

**Sponzori / Sponsors**

JGL d.o.o.  
Selvita d.o.o.  
Neuchemie d.o.o.  
Shimadzu d.o.o.  
Pliva Hrvatska d.o.o.  
Siemens d.d.  
MERCK d.o.o.  
XELLIA d.o.o.  
ChemEngineering Journal MDPI izdavač / *publisher*  
Altium d.o.o.  
BIOVIT d.o.o.  
Medic d.o.o.  
TCI Europe

**Donatori / Donators**

Atlantic Grupa d.d. (Barcaffè)  
Turistička zajednica grada Zagreba

**Mjesto održavanja / Meeting Venue**

Sveučilište u Zagrebu Fakultet kemijskog inženjerstva i tehnologije, Trg Marka Marulića 19 & 20,  
HR-10 000 Zagreb /  
*University of Zagreb Faculty of Chemical Engineering and Technology, Trg Marka Marulića 19 & 20,  
HR-10 000 Zagreb*

## UVODNIK

Susret mladih kemijskih inženjera (SMLKI) je znanstveno-stručni skup koji se od 1996. tradicionalno održava svake druge godine u organizaciji Hrvatskog društva kemijskih inženjera i tehnologa i Sveučilišta u Zagrebu Fakulteta kemijskog inženjerstva i tehnologije, a od 2022. godine postaje međunarodni skup.

XV. susret mladih kemijskih inženjera ove godine održava se 22. i 23. veljače na Fakultetu kemijskog inženjerstva i tehnologije u Zagrebu.

Skup je prilika za studente, mlade istraživače, kemijske inženjere i stručnjake iz srodnih područja da steknu prva iskustva u prezentaciji rezultata vlastitih istraživanja, što je iznimno važno za njihov profesionalni razvoj. Glavni cilj je afirmirati mlade stručnjake i struku predstavljanjem rezultata znanstvenih i stručnih istraživanja ostvarenih tijekom studija.

Stoga ovim skupom ohrabrujemo i potičemo mlade stručnjake na kreiranje i realizaciju novih ideja, kao i pokretanje profesionalne suradnje. Isto tako, omogućujemo stjecanje uvida u smjerove tehnološkog razvoja i proširujemo horizonte naglašavajući važnost interdisciplinarnog pristupa u istraživanju, razvoju i provedbi tehnoloških procesa. Upravo se potreba za interdisciplinarnosti istraživanja, primjena suvremenih analitičkih i računalnih tehnika i zelenih održivih tehnologija, kao i potreba za prijenosom tehnologije između akademije i industrije ogleda u odabiru plenarnih i pozvanih predavača.

Na ovogodišnjem Susretu sudjeluje 237 sudionika sa 165 priopćenja. Održat će se 2 plenarna, 6 pozvanih, 1 pozvano predavanje mladog nagrađenika, 23 predavanja u sekcijama uz 133 posterska priopćenja, kao i predstavljanja četiriju sponzora.

Poticaj na sudjelovanje na skupu i ove godine je nagrada za najbolja posterska priopćenja i najbolje izlaganje u kategoriji sekcijskih predavanja. Cjeloviti radovi sa Susreta objavit će se u posebnom izdanju časopisa Kemija u industriji.

Na kraju zahvaljujemo svim sudionicima na njihovom doprinosu uz poruku da prigrle sve izazove s entuzijazmom, da budu inspiracija jedni drugima i da budu otvoreni za nova znanja i suradnju jer samo na takav način možemo konstruktivno utjecati na budućnost kemijsko inženjerske struke u Hrvatskoj.

Svim sudionicima želimo ugodno druženje tijekom Skupa i uspjeh u daljnjem radu!

Predsjednica Znanstveno-organizacijskog odbora  
Doc. dr. sc. Željka Ujević Andrijić

## FOREWORD

The Meeting of Young Chemical Engineers (SMLKI) is a scientific and professional event that has been traditionally held every two years since 1996, organized by the Croatian Society of Chemical Engineers and Technologists and the University of Zagreb Faculty of Chemical Engineering and Technology. Starting from the year 2022, it has become an international conference.

The XV. Meeting of Young Chemical Engineers is taking place this year on February 22<sup>nd</sup> and 23<sup>rd</sup> at the Faculty of Chemical Engineering and Technology in Zagreb. The conference provides an opportunity for students, young researchers, chemical engineers, and professionals from related fields to gain their first experience in presenting the results of their research, which is crucial for their professional development.

The main goal is to promote young professionals and the profession by showcasing the results of scientific and professional research conducted during their studies. Therefore, this conference encourages and supports young professionals in creating and implementing new ideas, as well as initiating professional collaboration.

Additionally, it facilitates gaining insights into the directions of technological development and broadens horizons by emphasizing the importance of an interdisciplinary approach in research, development, and implementation of technological processes. The need for interdisciplinary research, the application of modern analytical and computational techniques, and green sustainable technologies, as well as the transfer of technology between academia and industry, is reflected in the selection of plenary and invited speakers.

This year's Meeting involves 237 participants with 165 abstracts. The program includes 2 plenary sessions, 6 invited lectures, 1 invited lecture by a young laureate, 23 section presentations with 133 poster presentations, and introductions from four sponsors.

Encouragement to participate in the conference this year includes awards for the best poster presentations and the best presentation in the section lecture category. The conference proceedings from the Meeting will be published in a special edition of the journal *Chemistry in Industry*.

In conclusion, thanks are extended to all participants for their contributions, with a message to embrace all challenges with enthusiasm, to be an inspiration to one another, and remain open to new knowledge and collaboration. This constructive approach is essential for positively influencing the future of the chemical engineering profession in Croatia. Wishing all participants a pleasant time during the conference and success in their future endeavors!

Chair of the Scientific and Organizing Committee  
Assist. Prof. Željka Ujević Andrijić

**SADRŽAJ**  
***CONTENTS***



## **PLENARNA PREDAVANJA / PLENARY LECTURES**

### **Bojan Jerbić**

UMJETNA INTELIGENCIJA – IZAZOV DIGITALNE BUDUĆNOSTI  
*ARTIFICIAL INTELLIGENCE – THE CHALLENGE OF THE  
DIGITAL FUTURE*.....1

### **Sanja Martinez**

*THE CHALLENGES OF TECHNOLOGY TRANSFER IN CORROSION ENGINEERING*.....2

## **POZVANA PREDAVANJA / INVITED LECTURES**

### **Maša Safundžić Kučuk**

KAKO FAKULTETSKO GRADIVO POSTAJE LIJEK: PUSTOLOVINA OD  
KNJIGE DO LJEKARNE  
*HOW COLLEGE MATERIAL BECOMES MEDICINE: ADVENTURES FROM  
BOOK TO PHARMACY*.....4

### **Ivan Güttler**

KLIMATSKE PROMJENE: SAŽETAK NAJNOVIJEG ZBIRNOG IZVJEŠĆA MEĐUVLADINOG  
PANELA O KLIMATSKIM PROMJENAMA (IPCC)  
*CLIMATE CHANGE: SUMMARY OF THE LATEST INTERGOVERNMENTAL PANAL ON CLIMATE  
CHANGE (IPCC) REPORT*.....5

### **Primož Jovanovič**

*EN ROUTE TO SUSTAINABLE OXYGEN ELECTROCATALYSIS: EMPLOYMENT OF ADVANCED  
ELECTROCHEMICAL METHODS*.....6

### **Igor Dejanović**

MOŽE LI DESTILACIJA BITI ZELENI PROCES?  
*CAN DISTILLATION GO GREEN?*.....7

### **Ivana Šoljić Jerbić**

IZAZOVI U RAZVOJU INOVATIVNIH KOMPLEKSNIH LIJEKOVA S PRODULJENIM  
OSLOBAĐANJEM  
*CHALLENGES IN THE DEVELOPMENT OF INNOVATIVE COMPLEX MEDICINES WITH  
EXTENDED RELEASE*.....8

### **Arijana Filipić**

*NOVEL TECHNOLOGY FOR CLEAN WATER*.....9

### **Katarina Mužina**

MAKRO USPJESI NA NANO RAZINI - ČARI ZNANSTVENOG ISTRAŽIVANJA  
*MACRO SUCCESSES ON THE NANO LEVEL – THE CHARMS OF SCIENTIFIC RESEARCH*.....10

## USMENA IZLAGANJA / ORAL PRESENTATIONS

<b>Lamija Ahmetović, Veronika Furlan, Urban Bren</b> <i>COMPUTATIONAL MODELING OF ANTI-CARCINOGENIC EFFECTS OF NARINGENIN</i> .....	12
<b>Martina Bagović, Kristina Radošević, Manuela Panić, Marina Cvjetko Bubalo, Ivana Radojčić Redovniković</b> <i>IMPROVEMENT OF MACROLIDE ANTIBIOTIC PROPERTIES BY RATIONALE DESIGN OF DEEP EUTECTIC SOLVENTS</i> .....	13
<b>Nikolina Beljan, Ivan Nemet, Sanda Rončević</b> <i>MORFOLOŠKE ZNAČAJKE ŽELJEZOVIH NANOČESTICA PRI SORPCIJI ODABRANIH IONA LANTANOIDA</i> <i>MORPHOLOGICAL CHARACTERISTICS OF IRON NANOPARTICLES AFTER LANTHANIDES ION SORPTION</i> .....	14
<b>Nika Bilić, Renata Biba, Mario Cindrić</b> <i>DEVELOPMENT OF MULTIDIMENSIONAL CHROMATOGRAPHY FOR SEPARATION OF PEPTIDES USING AUTOMATED SOLID-PHASE MICROEXTRACTION</i> .....	15
<b>André Cabrita, Sandra Gomes, Jaime Fernandes, Nuno Alvarenga, Paulo Cameira dos Santos, Miguel Minhalma</b> <i>CONCENTRATION AND PURIFICATION OF CARDOON (<i>Cynara cardunculus L.</i>) FLOWER EXTRACTS BY ULTRAFILTRATION</i> .....	16
<b>Mehmet Mervan Çakar, Theofania Andreadaki, Simon Charnock, Wolf-Dieter Fessner, Zvezdana Findrik Blažević</b> <i>KINETIC CHARACTERIZATION OF BIOCATALYSTS IN SYNTHESIS OF N-ACETYLNEURAMINIC ACID</i> .....	17
<b>Ines Cazin, Milena Olga Gleirscher, Mathias Fleisch, Marco Sangermano, Sandra Schlögl</b> <i>SPATIALLY CONTROLLING THE MECHANICAL PROPERTIES OF 3D PRINTED OBJECTS BY DUAL-WAVELENGTH DIGITAL LIGHT PROCESSING</i> .....	18
<b>Luka Dornjak, Anamarija Rogina</b> <i>CHITOSAN/BIOACTIVE GLASS SCAFFOLDS AS POTENTIAL DRUG CARRIERS</i> .....	19
<b>David Fabek</b> <i>DIGITALNI BLIZANAC INDUSTRIJSKOG POSTROJENJA</i> <i>DIGITAL TWIN OF AN INDUSTRIAL PLANT</i> .....	20
<b>Mateja Filković, Maja Mihoci, Tea Mihelj Josipović, Iva Perić, Domagoj Vrsaljko</b> <i>CHALLENGES OF GLASS AS A PRIMARY PACKAGING MATERIAL FOR BLACK ALKALINE STERILE FORMULATION</i> .....	21
<b>Mia Gotovuša, Paula Huzjak, Marta Krasić, Martina Zdravec, Jelena Parlov Vuković, Fabio Faraguna</b> <i>THE INFLUENCE OF THE STRUCTURE OF BRANCHED ISOMER OF SELECTED HIGHER ALCOHOL AND REACTION PARAMETERS ON BIODIESEL SYNTHESIS FROM WASTE COOKING OIL</i> .....	22
<b>Danica Jovašević</b> <i>SYNTHESIS OF POLYAMIDO-SILOXANES</i> .....	23

<b>Karla Kukina Gradečak, Katarina Leko, Andrea Usenik, Nikola Cindro, Vladislav Tomišić</b> KOMPLEKSIRANJE ALKALIJSKIH I ZEMNOALKALIJSKIH KATIONA S TERCIJARNIM AMIDNIM DERIVATOM KALIKS[6]ARENA <i>COMPLEXATION OF ALKALI AND ALKALINE EARTH METAL CATIONS BY TERTIARY-AMIDE CALIX[6]ARENE DERIVATIVE</i> .....	24
<b>Anabela Ljubić, Ivan Karlo Cingesar, Domagoj Vrsaljko, Anita Šalić, Irena Škorić</b> <i>DEVELOPMENT OF AN INTEGRATED MILLISYSTEM FOR CONTINUOUS SYNTHESIS AND SEPARATION OF RESVERATROL ANALOGUES</i> .....	25
<b>Petra Maleš, Danijela Bakarić</b> <i>THE SIGNIFICANCE OF CHOLESTEROL FOR MYELIN LIPID PHASES</i> .....	26
<b>Antonio Močinić, Ozana Mišura, Marijana Đaković</b> KRISTALI IZLOŽENI MEHANIČKOM STRESU: OTKRIVANJE FLEKSIBILNIH ODZIVA <i>CRYSTALS UNDER MECHANICAL STRESS: UNRAVELING FLEXIBLE RESPONSIVENESS</i> .....	27
<b>Anđela Nosić, Marijan-Pere Marković, Domagoj Vrsaljko</b> SOL-GEL METODA PRIPREME pH-SENZORSKIH FILMOVA NA OSNOVI LAKMUSA ZA PRIMJENU U MIKROREAKTORIMA <i>PREPARATION OF pH SENSOR FILMS BASED ON LITMUS BY THE SOL GEL METHOD FOR THE APPLICATION IN MICROREACTORS</i> .....	28
<b>Nikola Rimac, Željka Ujević Andrijić</b> SKRIVENO U PODACIMA: MJERENJE NEMJERLJIVOGA <i>HIDDEN IN THE DATA: MEASURING THE UNMEASURABLE</i> .....	29
<b>Petra Roksandić, Irena Barukčić Jurina, Rajka Božanić, Katarina Lisak Jakopović</b> <i>IMPACT OF MORINGA EXTRACT (Moringa oleifera) ON THE FERMENTATION PROCESS OF GOAT MILK</i> .....	30
<b>Katarina Sokač, Lucija Vrban, Robert Vianello, Irena Škorić, Krunoslav Žižek</b> <i>SOLVENT-FREE MECHANOCHEMICAL SYNTHESIS OF DASATINIB-CYCLODEXTRIN INCLUSION COMPLEXES – COMPUTATIONAL AND EXPERIMENTAL STUDY</i> .....	31
<b>Ivana Stojmilović, Tomislav Domanovac, Monika Šabić Runjavec, Martina Trtinjak, Marija Vuković Domanovac</b> <i>KINETIC MODELLING EX-SITU BIOREMEDIATION OF LEACHATE</i> .....	32
<b>Lucija Vlahović, Andrea Lončarević, Anamarija Rogina</b> KOMPOZITNE MIKROČESTICE NA TEMELJU KITOZANA I HIDROKSIAPATITA KAO NOSAČI LIJEKA <i>CHITOSAN/HYDROXYAPATITE COMPOSITE MICROPARTICLES AS DRUG CARRIER</i> .....	33
<b>Marko Zubak, Sara Krivačić, Željka Boček, Petar Kassal</b> <i>FABRICATION OF AN INKJET-PRINTED ELECTROCHEMICAL AZITHROMYCIN SENSOR USING INTENSE PULSED LIGHT</i> .....	34

## **POSTERSKA IZLAGANJA / *POSTER PRESENTATIONS***

BIOKEMIJSKO INŽENJERSTVO / <i>BIOCHEMICAL ENGINEERING</i> .....	36
EKOINŽENJERSTVO / <i>ENVIRONMENTAL ENGINEERING</i> .....	60
KEMIJSKO INŽENJERSTVO / <i>CHEMICAL ENGINEERING</i> .....	69
PRIMIJENJENA KEMIJA / <i>APPLIED CHEMISTRY</i> .....	91
RAZVOJ MATERIJALA I PROIZVODA / <i>MATERIALS AND PRODUCTS DEVELOPMENT</i> .....	140

**PLENARNA PREDAVANJA**  
***PLENARY LECTURES***

UMJETNA INTELIGENCIJA – IZAZOV DIGITALNE BUDUĆNOSTI  
ARTIFICIAL INTELLIGENCE - THE CHALLENGE OF THE DIGITAL FUTURE

**Bojan Jerbić**

Sveučilište u Zagrebu Fakultet strojarstva i brodogradnje, Ulica Ivana Lučića 5, 10000, Zagreb, Hrvatska  
Regionalni centar izvrsnosti za robotske tehnologije – CRTA, Ulica Ivana Lučića 5, 10000, Zagreb, Hrvatska  
bojan.jerbic@fsb.unizg.hr

Umjetna inteligencija (AI) više je od same tehnologije. To nije samo skup novih znanstvenih metoda ili instrumenata. S napretkom u strojnom učenju, obradi jezika i robotici, poprima iznimnu snagu koja preoblikuje i revolucionira naš život u civilizacijskom, kulturološkom i gospodarskom smislu. Umjetna inteligencija može unaprijediti kvalitetu našeg života, ne samo u smislu ekonomske koristi, povećanja radne učinkovitosti, već i u smislu ukupnih društvenih učinaka. U prošlosti je tehnološki napredak izravno utjecao na povećanje životnog vijeka, stope pismenosti i unapređenje globalne ekonomije. To tada nije bila slučajnost, niti će biti u budućnosti. Za razumijevanje utjecaja umjetne inteligencije i robotike na oblikovanje naše digitalne budućnosti važno je učiti iz prošlih uspjeha i neuspjeha, kao i razumjeti njihove znanstvene koncepte, razvojne smjerove i potencijalne pravne, etičke i socioekonomske implikacije. Tehnološki razvoj ne dolazi izvana, već predstavlja refleksiju ljudskog društva i nas samih. Kao i kod svake snažne i transformativne tehnologije, postoje značajni izazovi koje treba riješiti. Proaktivnim suočavanjem s izazovima i iskorištavanjem sposobnosti umjetne inteligencije, možemo stvoriti budućnost u kojoj umjetna inteligencija osnažuje čovječanstvo da postigne napredak bez presedana u digitalnom dobu.

## THE CHALLENGES OF TECHNOLOGY TRANSFER IN CORROSION ENGINEERING

**Sanja Martinez, Ivana Šoić**

University of Zagreb Faculty of Chemical Engineering and Technology,  
Trg Marka Marulića 19, 10000 Zagreb, Croatia  
sanja.martinez@fkit.unizg.hr

Polymer-based protective coatings are the single most important method for the corrosion protection of metals. The market for protective coatings is estimated to be worth a couple hundred billion USD and 60% of the market is in the industrial paints and coatings category. The coatings industry is highly regulated and coating manufacturers are constantly compelled to push the limits of environmental compatibility and durability of coatings. Electrochemical impedance spectroscopy (EIS) is a sensitive tool for investigating the protective properties of coatings that can significantly advance the development and application of coatings. Despite decades of scientific research at the highest level and reports from industry, the technology transfer of this method into engineering practice has proven to be a daunting task and has so far only been successful in the aerospace industry and embodied in the recent AMPP TM21449-2021 standard entitled Continuous Measurements for Determination of Aerospace Coating Protective Properties. The even newer ASTM D8370-22 standard, Field Measurement of Electrochemical Impedance on Coatings and Linings, is a step towards the general use of EIS in industries that rely heavily on coatings for corrosion protection. However, the technical complexity of the standardized method is likely to prevent its widespread use.

In the following, we present the possibilities of repeated probing and continuous real-time online monitoring of the impedance of barrier coatings in natural or artificial environments using an innovative ReCorr®QCQ setup utilizing surface-mounted electrodes with quasi-solid-state and solid-state contact between coating and electrode. The challenges and solutions presented relate to the practical applicability of the method in the laboratory and in the field, the achievement of repeatable, reproducible and accurate impedance results for industrial coating systems conducting currents in the pA range, and the detection and elimination of AC interference. The transfer of EIS into practice involves not only technical advances but also conceptual advances using the latest experimental findings linking impedance loss to polymer cohesion and adhesion and their degradation by environmental stressors. The aim of low-frequency impedance monitoring of coatings is to detect early signs of coating degradation, thus facilitating coating selection and optimizing repair and renewal activities. In addition, the comparison of artificial and natural monitoring data and the associated weathering regimes can explain the differences between laboratory tests and the failure modes of coatings in service. The purpose of fast, easy and automated impedance monitoring of coatings is to provide cost savings to asset owners while maximizing asset life.

2

- [1] S. Martinez et al., *Corrosion* 79 (9) 1029-1039.
- [2] B. Hudec et al., *Mater. Perform.* 61 (2022) 52-56.
- [3] I. Šoljić et al., *Prog. Org. Coat.* 165 (2022), 106767.
- [4] S. Martinez et al., *Prog. Org. Coat.* 153 (2021), 106155.

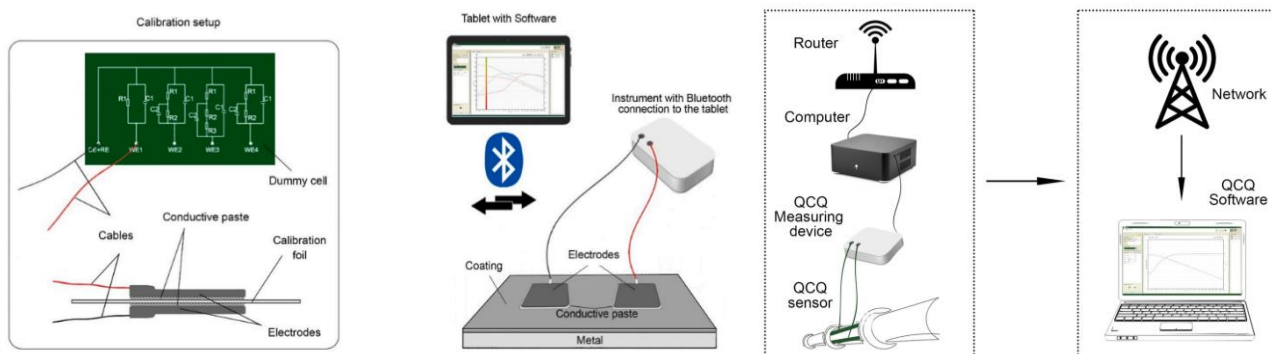

**POZVANA PREDAVANJA**  
***INVITED LECTURES***



## KAKO FAKULTETSKO GRADIVO POSTAJE LIJEK: PUSTOLOVINA OD KLUPE DO LJEKARNE

## HOW COLLEGE MATERIAL BECOMES MEDICINE: ADVENTURES FROM BOOK TO PHARMACY

### **Maša Safundžić Kučuk**

Jadran Galenski Laboratorij d.d., Svilno 20, 51000 Rijeka, Hrvatska  
masa.safundzic@jglpharma.com

Kako bi farmaceutska tvrtka razvila i dovela siguran, učinkovit i kvalitetan lijek na police ljekarni, interdisciplinarni tim stručnjaka mora integrirati cijeli niz temeljnih znanja kako bi postavio protokole ispitivanja, rastumačio rezultate dobivenih mjerenja i opravdao sukladnost s cijelim nizom regulative.

Da bi bili uspješni, stručnjaci koji rade na razvoju lijekova moraju imati cijeli niz znanja iz prirodnih i tehničkih znanosti. Kroz primjere iz JGL prakse, proći ćemo kroz proces razvoja generičkog farmaceutskog proizvoda i povezati ih sa znanjima potrebnima za njihovu uspješnu realizaciju.

Prvi je korak detaljna patentna i druga literaturna pretraga koja profilira do sad poznata saznanja i provedena istraživanja, kao i eventualna patentna ograničenja. S obzirom da je JGL generička kompanija fokusirana na topikalne proizvode (za oko, nos i kožu), temeljni zadatak istraživača u razvoju proizvoda čini dokazivanje kvalitativne (Q1), kvantitativne (Q2) i mikrostrukturne (Q3) ekvivalentnosti razvijenog proizvoda s referentnim lijekom. Kako je potpuni sastav referentnog lijeka uglavnom nepoznat, a dozvoljena su odstupanja mala, istraživači moraju provesti ispitivanja pomoću kojih će odrediti što točniji Q1/Q2 sastav referentnog lijeka. Nakon postavljanja vlastite formulacije provode se ispitivanja kojima se dokazuje sličnost s referentnim lijekom, a u slučaju razlika, potrebno je osmisliti ispitivanja kojima se ustanovljava utječu li razlike na sigurnost i efikasnost lijeka. Stupanj sličnosti razvijenog i referentnog lijeka utjecat će na opseg kliničkih ispitivanja.

Uz navedeno, a kako bi se dokazalo da je kvaliteta lijeka planirana, kontrolirana i osigurana od početka razvoja lijeka te tijekom cijelog procesa proizvodnje, potrebno je na znanstveno utemeljeni način odrediti, potvrditi i osigurati kontrolnu strategiju za kritične attribute odabranih materijala (CMA), koji u kombinaciji s kritičnim procesnim parametrima (CPP) utječu na kritične attribute kvalitete gotovog proizvoda (CQA).

S obzirom na različitost sastava i načina proizvodnje, razvoj svakog proizvoda traži kombinaciju cijelog niza istraživačkih tehnika i znanja, kao i dubinsko poznavanje tehnologija i velikog broja regulatornih zahtjeva i smjernica.

- [1] European Medicines Agency, Note for Guidance on Development Pharmaceuticals, 1998, CPMP/QWP/155/96.
- [2] European Medicines Agency, Draft Guideline on quality and equivalence of topical products, 2018, CHMP/QWP/708282/2018.
- [3] V. P. Shah et al., Int. J. Pharm. 491 (2015) 21.

KLIMATSKE PROMJENE: SAŽETAK NAJNOVIJEG ZBRINOG IZVJEŠĆA  
MEĐUVLADINOG PANELA O KLIMATSKIM PROMJENAMA (IPCC)  
CLIMATE CHANGE: SUMMARY OF THE LATEST INTERGOVERNMENTAL  
PANAL ON CLIMATE CHANGE (IPCC) REPORT

**Ivan Güttler**

Državni hidrometeorološki zavod, Ravnice 48, 10000 Zagreb, Hrvatska  
ivan.guettler@cirus.dhz.hr

Međuvladin panel o klimatskim promjenama (IPCC) je osnovan 1988. i do sada je proveo šest ciklusa procjena klimatskih promjena. Njegova uloga je procijeniti znanstvenu, tehničku i socio-ekonomsku literaturu relevantnu za razumijevanje klimatskih promjena, njihovih posljedica i budućih rizika te opcije za prilagodbu i ublažavanje. Zbirno izvješće šestog izvješća o procjeni iz 2023. godine donosi najnovije informacije o (1) trenutačnom statusu i trendovima (2) budućim klimatskim promjenama, rizicima i dugoročnim odgovorima te (3) odgovorima u kratkoročnom razdoblju. U ovom predavanju prikazat će se rezultati koji ukazuju na jačanje štetnih učinaka klimatskih promjena uzrokovanih ljudskim djelovanjem. Prikazat će se i kako ograničavanje zagrijavanja na 1,5 °C i 2 °C uključuje brza, dubinska i u većini slučajeva trenutačna smanjenja emisija stakleničkih plinova. Konačno, unatoč problemima zadnjih godina kao što su kontinuirani porast koncentracije svih glavnih stakleničkih plinova u atmosferi, naglasit će se i pozitivni pomaci u istom razdoblju, a koju uključuju ubranu dostupnost obnovljivih izvora energije te jačanje sustava za prilagodbu na klimatske promjene i povezivanje sa zaštitom bioraznolikosti.

## EN ROUTE TO SUSTAINABLE OXYGEN ELECTROCATALYSIS: EMPLOYMENT OF ADVANCED ELECTROCHEMICAL METHODS

**Primož Jovanovič, Armin Hrnjić, Nejc Hodnik**

National Institute of Chemistry, Department of Materials Chemistry, Laboratory for Electrocatalysis, Hajdrihova 19, 1000, Ljubljana, Slovenia  
primoz.jovanovic@ki.si

Securing the growing energy demand currently relies on increased fossil fuel exploitation, leading to environmental issues and geopolitical crises. A critical task is accelerating the transition to green energy, with the hydrogen economy proposed as a key solution. Implementing hydrogen energy through electrochemical devices like fuel cells is crucial for global decarbonization. However, understanding and predicting the performance of high surface area catalysts in a proton exchange membrane fuel cells (PEMFC) remains challenging. Studies of the electrode reaction mechanism and kinetics, especially related to oxygen reduction reaction (ORR) as the rate-limiting reaction in PEMFCs, demand the application of viable, laboratory-scale friendly methodologies to assess the performance of the candidate materials for application in these devices. Extensive research in the past few decades has led to the establishment of different experimental protocols and various techniques to study the performance of electrocatalysts. Here the thin film rotating disk electrode (TF-RDE) methodology is by far the most widely used technique for the early-stage screening of the ORR activity and stability of novel catalysts. Unfortunately, the trends obtained in TF-RDE can significantly differ from those in a membrane electrode assembly (MEA) i.e., real-device counterparts. This is because in the former due to low  $O_2$  mass transport only potentials above 0.8 V vs RHE are accessible for kinetic analysis preventing one to obtain comprehensive ORR trends. Therefore, ORR performance is then only extrapolated to MEA-relevant lower potentials. In my talk I will discuss an alternative electrochemical tool, i.e., a modified floating electrode (MFE), recently introduced by our group. The MFE allows to pursue the reaction closer to PEMFC-relevant current densities since  $O_2$  reactant can be directly supplied to the working electrode and not through the liquid electrolyte. This results in a rapid mass transport giving access to a wide potential window and significantly larger current densities in comparison to the TF-RDE setup. Importantly, MFE exploits transmission electron microscopy (TEM) grids as electrode substrat enabling a detailed structural characterization of electrocatalyst down to atomic level [1–3].

6

- [1] P. Jovanovič, et al., *Anal. Chem.* 91 (2019) 10353–10356. <https://doi.org/10.1021/acs.analchem.9b01317>.  
 [2] A. Hrnjić, et al., *J. Electrochem. Soc.* 167 (2020) 166501. <https://doi.org/10.1149/1945-7111/abc9de>.  
 [3] A. Hrnjić, et al., *Electrochim. Acta.* (2021) 138513. <https://doi.org/10.1016/j.electacta.2021.138513>.

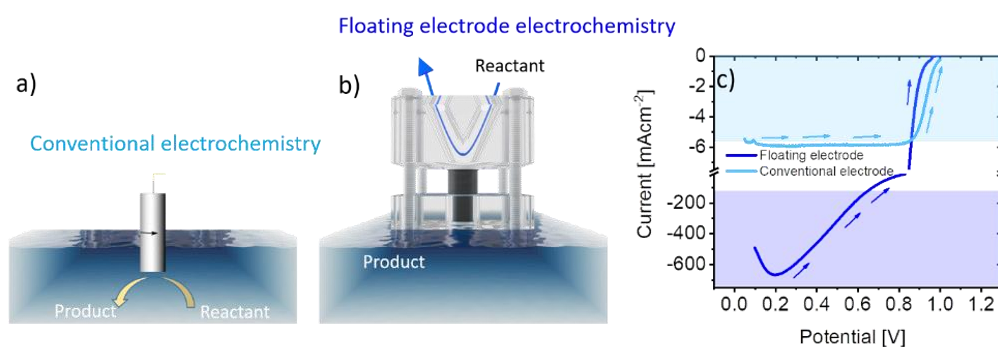

Figure 1. Schematic representation of electrochemical reaction proceeding in conventional electrode setups-a) and under modified floating electrode -b). c) Current response comparison, i.e., electrochemical reaction for the two setups indicating the superior performance of floating electrode for ORR.

## MOŽE LI DESTILACIJA BITI ZELENII PROCES?

### CAN DISTILLATION GO GREEN?

**Igor Dejanović**

Sveučilište u Zagrebu Fakultet kemijskog inženjerstva i tehnologije, Trg Marka Marulića 19, 10000 Zagreb, Hrvatska  
ideja@fkit.unizg.hr

Procesi destilacije ključna su tehnologija za odvajanje i pročišćavanje komponenata iz kapljevitih smjesa te imaju važnu ulogu u različitim sektorima kemijske procesne industrije. Procesi destilacije temelje se na ravnoteži kapljevinapara, pri čemu se toplina koristi kao separacijsko sredstvo. Zbog kontinuiranog isparavanja i kondenzacije znatnih količina tvari, ti su procesi energetske vrlo intenzivni što rezultira i znatnim posrednim utjecajem na okoliš. S obzirom da trenutno niti jedna druga separacijska tehnika ne može u potpunosti zamijeniti proces destilacije, pogotovo kod velikih kapaciteta, kao prijelazno rješenje razvijaju se brojni inovativni pristupi koji mogu doprinijeti transformaciji industrijske destilacije u zeleniji i po okoliš prihvatljiviji separacijski proces.

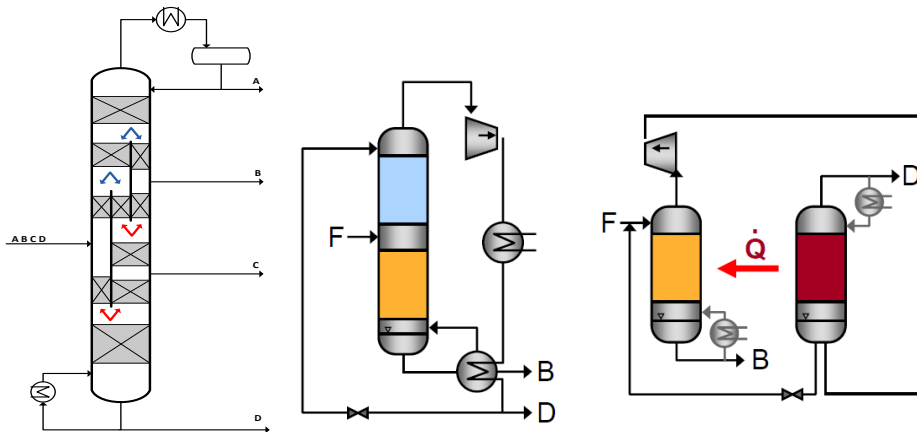

## IZAZOVI U RAZVOJU INOVATIVNIH KOMPLEKSNIH LIJEKOVA S PRODULJENIM OSLOBAĐANJEM

### CHALLENGES IN THE DEVELOPMENT OF INNOVATIVE COMPLEX MEDICINES WITH EXTENDED RELEASE

**Ivana Šoljić Jerbić**

Pliva Hrvatska d.o.o., Istraživanje i razvoj, Prilaz baruna Filipovića 25, 10000 Zagreb, Hrvatska  
ivana.soljicjerbic@pliva.com

U posljednjih nekoliko desetljeća zahvaljujući tehnološkom iskoraku u dizajnu terapijskih sustava za dostavu lijeka, farmaceutska industrija diljem svijeta sve se više usmjerava na razvoj inovativnih kompleksnih dozirnih oblika koje obilježava visoka terapijska učinkovitost i poboljšani sigurnosni profil što znatno unaprjeđuje kvalitetu života pacijentima. Takvi proizvodi osiguravaju farmaceutskim kompanijama i povoljnu tržišnu poziciju s obzirom na manju konkurentnost i jedinstveno intelektualno vlasništvo. Međutim, brojni su izazovi koje je potrebno premostiti kako bi takvi proizvodi došli iz laboratorija na tržište. U sklopu ovog predavanja prikazat će se razvojni put jednog inovativnog kompleksnog proizvoda s produljenim oslobađanjem djelatne tvari koji se razvijao u Plivinom istraživačkom institutu te koji je nedavno odobren od američke regulatorne agencije za lijekove te se nalazi na američkom tržištu.

- [1] K. Panchal et al., Drug Deliv. Transl. Res. 13 (2023) 433-472.
- [2] T.C. Ezike et al., Heliyon 9 (2023) e17488.
- [3] H. Wen et al., The AAPS J. 17 (2015) 1229-1146.

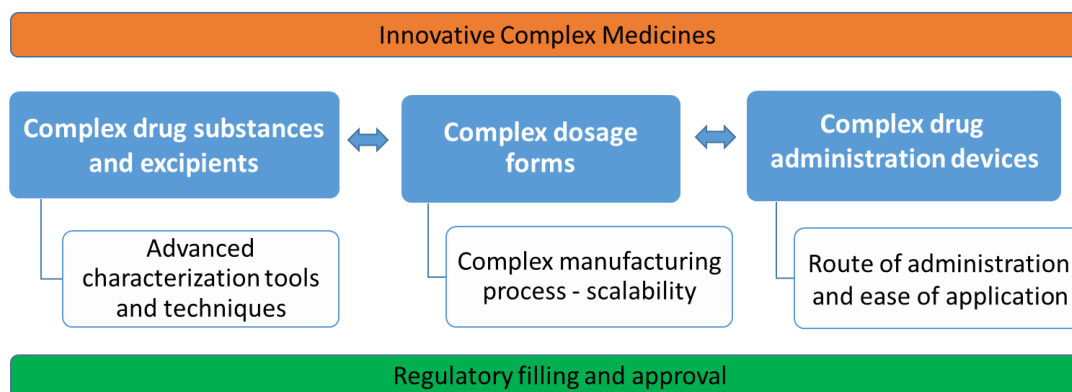

## NOVEL TECHNOLOGY FOR CLEAN WATER

**Arijana Filipić<sup>1</sup>, David Dobnik<sup>1</sup>, Ion Gutierrez Aguirre<sup>1</sup>, Rok Zaplotnik<sup>2</sup>,  
Gregor Primc<sup>2</sup>**

<sup>1</sup>National Institute of Biology, Večna pot 121, 1000, Ljubljana, Slovenia

<sup>2</sup>Jožef Stefan Institute, Jamova 39, 1000, Ljubljana, Slovenia

arijana.filipic@nib.si

The increase in the number and variety of pollutants is one of the driving forces behind water scarcity, one of the most pressing problems of our time. Among the many water contaminants are viruses, such as enteric viruses. They infect millions of people every year and lead to higher hospitalization and mortality rates and therefore need to be inactivated. One of the new technologies that has proven successful in inactivating viruses is cold plasma. Plasma, the fourth state of matter, is created when sufficient energy is added to a gas. This enables the generation of different species, including reactive species that have strong antimicrobial properties. For this reason, plasmas are increasingly being used to inactivate viruses [1]. The inactivation of viruses in larger volumes has only been investigated in a few studies [2], [3], mainly due to the challenge of plasma ignition in the liquids. To overcome this limitation, plasma can be combined with other technologies such as cavitation. Cavitation is a phenomenon in which water vapor bubbles or a single bubble form in the liquid due to the pressure drop [4]. The introduction of a gas phase into the liquid water enables the direct generation of plasma in the water sample, which can lead to improved virus inactivation and water decontamination. In our study, we used a unique and patented [5] technology combining cold plasma and a single cavitation bubble, i.e. supercavitation [6], to treat bacteriophage MS2 in water with different properties. We have shown that in water samples with unchanged parameters (initial temperature of  $\sim 21^{\circ}\text{C}$  and  $\text{pH} \sim 8$ ) containing  $10^5$  plaque forming units (PFU)/mL of virus, we can achieve virus inactivation of over 5 log, i.e., complete inactivation, after only two minutes. This was also the case when the initial temperature was lowered to  $11^{\circ}\text{C}$ . When the pH was lowered to  $\sim 6$ , inactivation improved and 5 log inactivation was achieved already after 1 minute. When the initial virus concentration was lowered to  $10^3$  PFU/ml, complete inactivation was achieved after 15 seconds, while 4 minutes were required for complete inactivation when the initial virus concentration was increased to  $10^7$  PFU/ml. The results obtained indicate that the novel plasma-supercavitation technology has great potential for the rapid inactivation of viruses in waters with different parameters. Therefore, it represents an alternative technology that could be used alone or in combination with other technologies to successfully decontaminate various water sources.

9

- [1] A. Filipić et al., Trends Biotechnol, vol. 38, no. 11 (2020) 1278–1291.  
 [2] A. Filipić et al., Food Environ Virol, vol. 11, no. 3, (2019) 220–228, 2019.  
 [3] A. Filipić et al., Front Microbiol, vol. 12, (2021) 1–12.  
 [4] M. Zupanc et al., Ultrason Sonochem, vol. 57, (2019) 147–165.  
 [5] G. Primc et al., US11807555B2 (2023).  
 [6] A. Filipić et al., Environment Inter., vol 182, (2023) 108285.

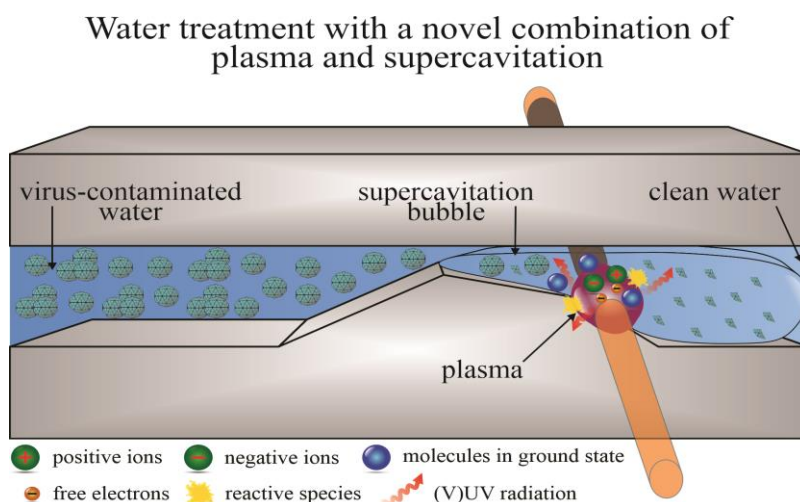

# MAKRO USPJESI NA NANO RAZINI – ČARI ZNANSTVENOG ISTRAŽIVANJA

## MACRO SUCCESSES ON THE NANO LEVEL – THE CHARMS OF SCIENTIFIC RESEARCH

**Katarina Mužina**

Sveučilište u Zagrebu Fakultet kemijskog inženjerstva i tehnologije, Trg Marka Marulića 19, 10000 Zagreb, Hrvatska  
kmuzina@fkit.unizg.hr

Koje su odlike dobrog znanstvenika? Koji su preduvjeti kvalitetnog znanstvenog istraživanja? Kako odabrati područje istraživanja te kako ne pokleknuti pred izazovima koji slijede? Što je to nanotehnologija, a što znanost o materijalima i zašto su bitne za naš svakodnevni život? Što je cerijev(IV) oksid, kako se dobiva i gdje se primjenjuje? Čime se sve bavi *žena u znanosti*? Zašto se uopće baviti znanostu? Na ova i još mnogo drugih pitanja bit će odgovoreno u ovom izlaganju koje će obuhvatiti moj put i razvoj u znanosti od studentskih dana pa sve do stjecanja doktorata znanosti i osmišljavanja budućih istraživanja. Bit će navedena različita uspješna, ali i ona manje uspješna istraživanja te smjernice kako na domišljat, inženjerski način doći do rješenja problema. Ponešto pažnje bit će posvećeno anorganskim nanomaterijalima, različitim načinima njihove sinteze, metodama karakterizacije i raznovrsnim mogućnostima primjene. Cilj je uvjeriti publiku da je znanost životni poziv koji zahtijeva puno odricanja, kreativnosti, otvorenosti uma te spremnosti na timski rad. Nagrada za uloženi trud (osim pokaže novčane nagrade i stipendije) jest mogućnost da unaprijedimo društvo i tehnologiju, a da se pritom dobro zabavimo te steknemo vrijedna znanja i neprocjenjivo iskustvo.

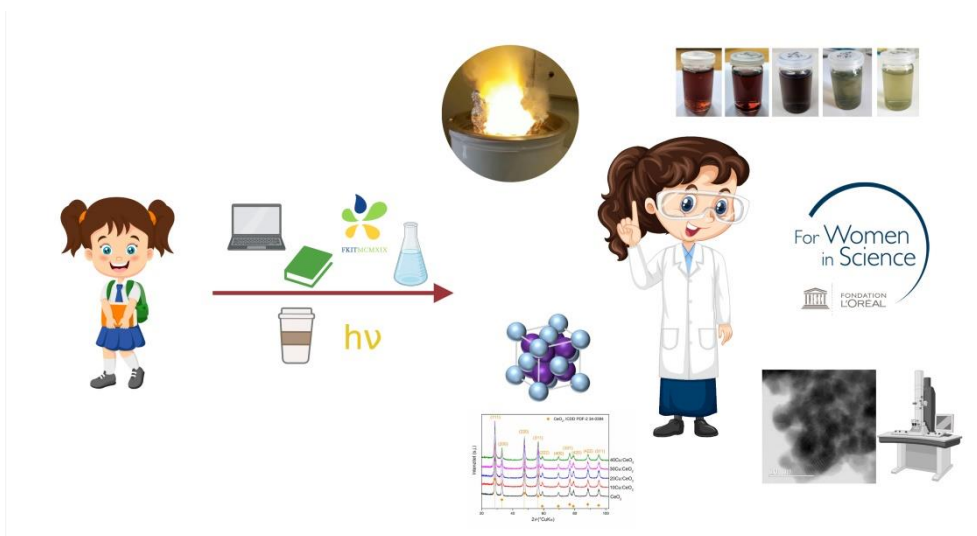

**USMENA IZLAGANJA**  
***ORAL PRESENTATIONS***



## COMPUTATIONAL MODELING OF ANTI-CARCINOGENIC EFFECTS OF NARINGENIN

**Lamija Ahmetović, Veronika Furlan, Urban Bren**

University of Maribor, Faculty of Chemistry and Chemical Engineering, Smetanova ulica 17, 2000 Maribor, Slovenia  
lamija.ahmetovic@student.um.si

Naringenin represents a bioactive polyphenol from citrus fruits with various beneficial health effects on human health [1]. The recent scientific literature reports that naringenin can suppress tumor development and progression [2], indicating it can be used for the treatment of different types of cancer [3,4]. Our research is focused on naringenin as a polyphenolic scavenger of nine ultimate chemical carcinogens, namely aflatoxin B1 exo-8,9-epoxide, 2-cyano ethylene oxide, ethylene oxide, glycidamide, chloroethylene oxide, vinyl carbamate epoxide, styrene oxide, propylene oxide, and  $\beta$ -propiolactone. The aim is to calculate the activation free energies and elucidate molecular mechanisms of alkylation reactions of naringenin with the studied genotoxic chemical carcinogens using the quantum-mechanical method Hartree-Fock in combination with two flexible basis sets. The calculations of activation free energies are performed on a Slovenian supercomputer cluster VRANA with the program Gaussian 16 in a vacuum as well as using two implicit Self-consistent reaction field solvation models [5]. To calculate activation free energies (free energy differences between the corresponding transition and reactant states), we prepared initial structures of reactants in Avogadro, and the corresponding cartesian coordinates were subsequently geometrically optimized with Gaussian 16 in the Linux operating system. The optimized reactants were then visualized in the program Molden to ensure they correspond to the local minimum. Relaxed potential surface scan was then applied to allocate the initial structures of transition states, which were subsequently geometrically optimized in an analogous way as reactants to allocate correct transition state structures corresponding to first order saddle points. To evaluate the scavenging efficacy of naringenin, the activation-free energies calculated in combination with solvation models were compared with the experimental values of the activation free energies between the same ultimate chemical carcinogens and the most reactive DNA base guanine. We firmly believe that this research will elucidate intricate molecular mechanisms of naringenin and have a vast impact on further computational as well as experimental studies of its anti-carcinogenic effects.

12

- [1] E. J. Stabrauskiene et al., *Biomedicines* 10 (2022) 1686.
- [2] J. He et al., *Pharmacol* 14 (2023) 1217001.
- [3] M. Motallebi et al., *Life Sciences* 305 (2022) 120752.
- [4] V. Furlan et al., *Foods* 12 (2023) 802.
- [5] V. Furlan et al., *Int. J. Mol. Sci.* 21 (2020) 695.

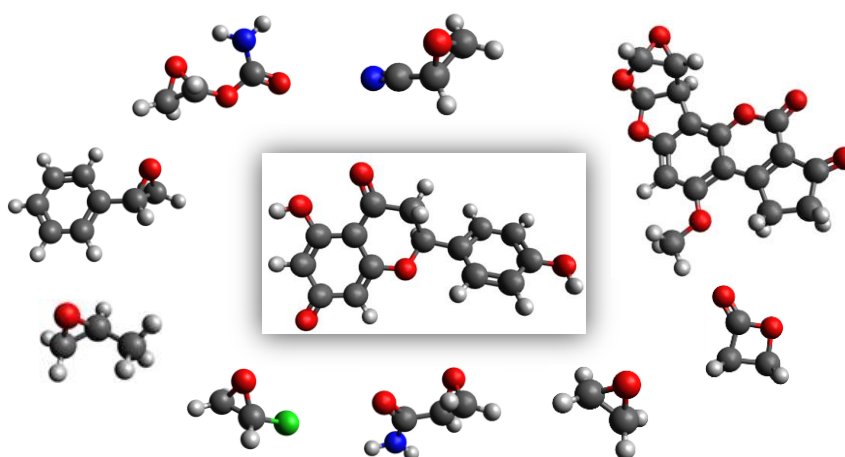

Figure 1. Naringenin as a polyphenolic scavenger of nine ultimate chemical carcinogens

## IMPROVEMENT OF MACROLIDE ANTIBIOTIC PROPERTIES BY RATIONALE DESIGN OF DEEP EUTECTIC SOLVENTS

**Martina Bagović, Kristina Radošević, Manuela Panić, Marina Cvjetko Bubalo, Ivana Radojčić Redovniković**

University of Zagreb Faculty of Food Technology and Biotechnology Pierottijeva 6, 10000 Zagreb, Croatia  
mbagovic@pbf.hr

Therapeutic Deep Eutectic Solvents (THEDES) have emerged as a compelling option within DES applications offering the potential to significantly impact the properties of various active pharmaceutical ingredients (APIs) [1,2]. This strategy involves the design of THEDES, constituting a eutectic system wherein an API serves as one of the components. DES are considered green solvents, because of their low toxicity and biodegradability [3]. This endeavor aims to enhance the solubility, permeability, and stability of APIs without compromising their efficacy [4,5]. The initial phase involves the application of the COSMOtherm program as an efficient tool for rational design, facilitating the fast screening of numerous compounds, thereby minimizing the time and resources required for de novo experiments. Such a tool streamlines the critical first step, making it more accessible and expeditious. By applying the COSMOtherm program and opting for DES with the lowest  $\ln\gamma$  value, directly linked to solubility, a challenging selection process identified three hydrophobic and three hydrophilic DES candidates for the targeted macrolide antibiotic (Compound X). Furthermore, computational selection is substantiated by HPLC analysis to determine experimental solubility and stability. Permeability assessments were conducted utilizing PAMPA, while the antimicrobial efficacy of the chosen API was assessed through disc diffusion assays involving a spectrum of gram-positive and gram-negative bacteria. In vitro cytocompatibility study was performed using the human cell line CaCo-2. The results that will be presented herein indicate that such an approach can be used to improve the solubility and permeability of the selected macrolide antibiotic.

- [1] M.H. Zainal-Abidina et al., J. Ind. Eng. Chem. 97 (2021) 142–162.
- [2] D.J.G.P. van Osch et al., ACS Sustainable Chem. Eng. 8, 29 (2020) 10591–10612.
- [3] K. Radošević et al., Ecotoxicol. Environ. Saf. 112 (2015) 46–53.
- [4] A.R.C. Duarte et al., Eur. J. Pharm. Biopharm. 114 (2017) 296–304.
- [5] A. Paiva et al., Sustainable Chem. Eng. 2 (2014) 1063–1071.

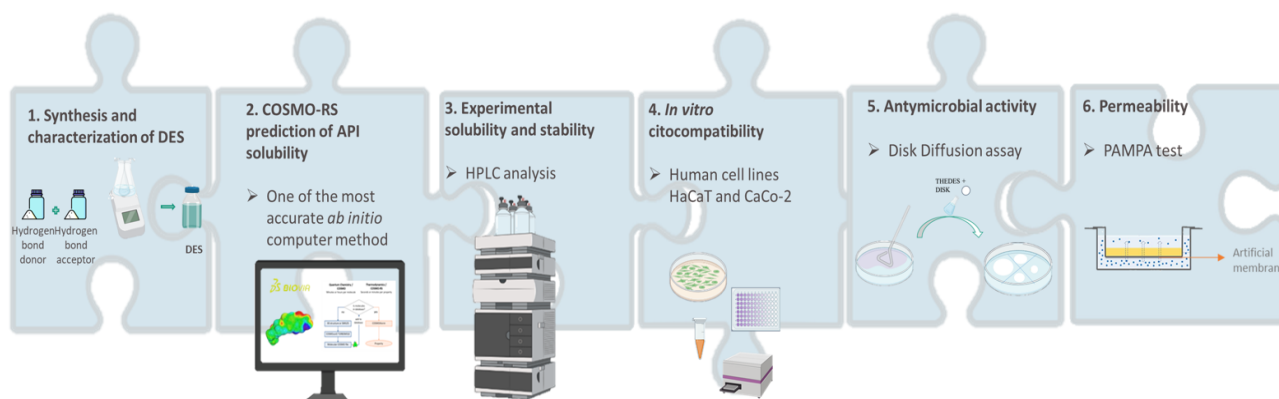

## MORFOLOŠKE ZNAČAJKE ŽELJEZOVIH NANOČESTICA PRI SORPCIJI ODABRANIH IONA LANTANOIDA

## MORPHOLOGICAL CHARACTERISTICS OF IRON NANOPARTICLES AFTER LANTHANIDES ION SORPTION

**Nikolina Beljan, Ivan Nemet, Sanda Rončević**

Sveučilište u Zagrebu Prirodoslovno-matematički fakultet, Kemijski odsjek, Horvatovac 102a, 10000 Zagreb, Hrvatska  
nbeljan@chem.pmf.hr

Tijekom zadnjih desetljeća došlo je do značajnog porasta u primjeni lantanoida u modernim tehnološkim uređajima poput mobilnih uređaja, LED osvjetljenja, DVD-a, punjivih baterija, katalitičkih pretvornika u motornim vozilima, supermagneta i sl. Gomilanje elektroničkog otpada i eksploatacija ruda koje sadrže lantanoide dovodi do povećanja koncentracija tih elemenata u okolišu, posebice u tlu i prirodnim vodama.<sup>1</sup> Zbog njihovog potencijalno štetnog utjecaja po zdravlje ljudi, od velike je važnosti pronaći učinkovitu metodu za njihovo uklanjanje iz zagađenih voda i tla. Trenutno se provode iscrpna istraživanja o učinkovitosti nanočestica željeza u uklanjanju zagađivača iz okoliša. Zbog vrlo velike specifične površine i posljedično velikog adsorpcijskog kapaciteta te velike reaktivnosti prema raznim organskim i anorganskim zagađivačima, nanočestice elementarnog željeza pronašle su primjenu u pročišćavanju tla i prirodnih voda. Za razliku od elementarnog željeza na makroskopskoj skali, poput praha željeza, nanodimenzije osiguravaju poboljšanu mobilnost čestica kroz porozni medij. Struktura načinjena od jezgre građene od elementarnog željeza i ljuske građene od sloja oksida željeza, osigurava kemijsku stabilnost te različite mehanizme razgradnje i sorpcije zagađivača.<sup>2,3</sup> U ovom radu okarakterizirane su nanočestice elementarnog željeza i nanočestice s modificiranom površinom radi boljeg razumijevanja utjecaja strukture na mehanizme sorpcije iona lantanoida. Nanočestice su sintetizirane redukcijom željezova(III) klorida s natrijevim borhidridom nakon čega je uslijedila površinska modifikacija dodatkom dipikolinske kiseline. Strukturna analiza nanočestica željeza provedena je pomoću metoda pretražne elektronske mikroskopije (SEM) i mikroskopije atomskih sila (AFM). Dobiveni rezultati ukazuju kako površinska modifikacija i adsorpcija odabranih lantanoida utječu na strukturu i veličinu nanočestica.

14

- [1] V. Balaram, Geosci. Front. 10 (2019) 1285–1303.  
[2] J. Byung-Moon et al., Chem. Eng. J. 475 (2023) 146222.  
[3] A. Galdames et al., Int. J. Environ. Res. Public Health 17 (2020) 5817.

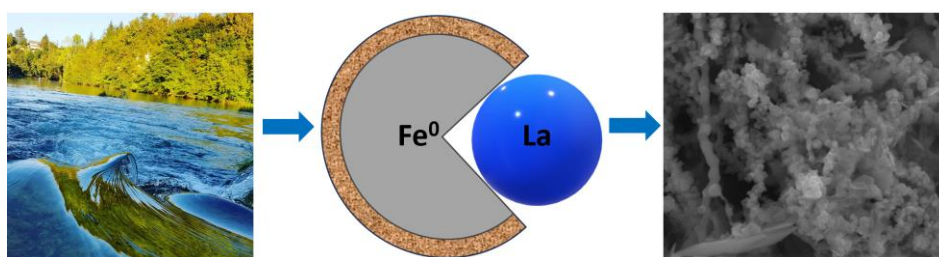

## DEVELOPMENT OF MULTIDIMENSIONAL CHROMATOGRAPHY FOR SEPARATION OF PEPTIDES USING AUTOMATED SOLID-PHASE MICROEXTRACTION

**Nika Bilic<sup>1,2</sup>, Renata Biba<sup>2</sup>, Mario Cindrić<sup>2</sup>**

<sup>1</sup> University of Zagreb Faculty of Food Technology and Biotechnology, Pierottijeva 8, 10000 Zagreb, Croatia

<sup>2</sup> Ruđer Bošković Institute, Division of Molecular Medicine, Bijenička 54, 10000 Zagreb, Croatia  
nika200092@gmail.com

Multidimensional liquid chromatography in combination with mass spectrometry plays an important role in proteomics research due to its separation performance, maximum identification and high speed [1]. The main objective of this study was to evaluate the orthogonality of multidimensional separation of bovine serum albumin (BSA) and tryptic peptides by comparing the retention times as elution products on different stationary phases. Various types of stationary phases with different thickness and polarity are commercially available, which exhibit high selectivity for different analytes. In this study, we compared the fractionation capabilities of four different stationary phases: MAX (strong anion exchange in mixed mode, reversed phase), SCX (strong cation exchange), HLB (hydrophilic-lipophilic balance), QMA (quaternary methylammonium, strong anion exchange) and RP (reversed phase, pH 2.5 and pH 10). Fractionation was performed with PosiTip One (bene lab, Zagreb), an easy to use and quick to set up liquid platform for solid phase microextraction (SPME) using home-made cartridge columns. SPME is a simple and efficient, solvent-free sample preparation method that is ideal for mass spectrometry (MS) applications. Specific priming, equilibration and elution buffers were used for each stationary phase. Six fractions of each sample were then analyzed using an LC-MS system (nano-LC-ESI-qTOF), and the raw data were processed using a protein database search engine. The results showed that the combination of MAX in the first dimension with either SCX or QMA in the second dimension resulted in dispersed plots, suggesting that these are ideal stationary phase combinations for multidimensional separation of peptides.

[1] G. Vas and K. Vékey, Anal. Sci. 39 (2004) 233-254.

15

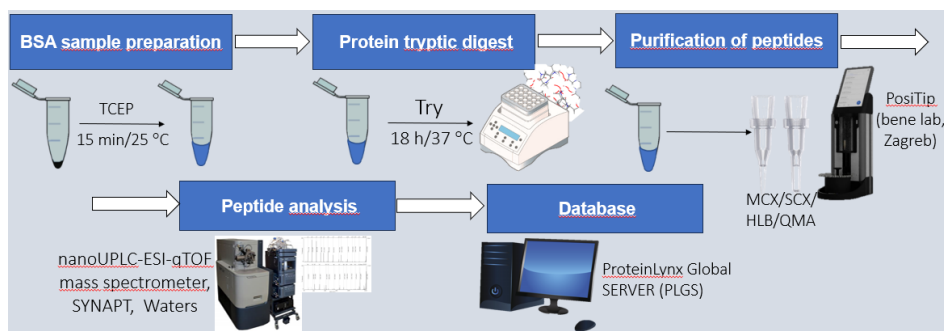

## CONCENTRATION AND PURIFICATION OF CARDOON (*Cynara cardunculus* L.) FLOWER EXTRACTS BY ULTRAFILTRATION

**André Cabrita<sup>1</sup>, Sandra Gomes<sup>2</sup>, Jaime Fernandes<sup>2</sup>, Nuno Alvarenga<sup>2,3</sup>, Paulo Cameira dos Santos<sup>2</sup>, Miguel Minhalma<sup>1,4</sup>**

<sup>1</sup>DEQ, Instituto Superior de Engenharia de Lisboa, Lisbon, Portugal

<sup>2</sup>Unidade de Tecnologia e Inovação, Instituto Nacional de Investigação Agrária e Veterinária, Oeiras, Portugal

<sup>3</sup>Center GeoBioTec Research Center, Faculdade de Ciência e Tecnologia, Nova University Lisbon, Lisbon, Portugal

<sup>4</sup>Center of Physics and Engineering of Advanced Materials (CeFEMA), Instituto Superior Técnico, University of Lisbon, Lisbon, Portugal  
andre.cabrita@isel.pt

The cardoon flower (*Cynara cardunculus* L.) is a mandatory vegetable coagulant to produce certain Protected Designation of Origin (PDO) Portuguese cheeses. However, the flower harvesting is not controlled and therefore leads to extracts with varying enzymatic activities contributing to the lack of homogeneity of the cheeses, with the consequent loss of value [1]. This fact leads to the need for further studies in order to optimize this coagulant standardization, several different approaches are being tested, one of them is the production of extracts by ultrafiltration, resulting in a concentrate with a high enzymatic activity. First, four different cellulose acetate membranes were prepared in the laboratory following the phase inversion method, and the coagulant extract were prepared from cardoon flower pistils collected in Oeiras, following a traditional method of preparation for cheesemaking, using 120 g of cardoon flower pistils macerated by hand in a mortar, adding up to a final volume of 3 L of aqueous solution. The milk clotting activity of the extracts were evaluated, according to ISO 23058/IDF 199. The membranes were prepared using 17 g of Cellulose Acetate, and different quantities of Formamide and Acetone, reaching a total of 100 g of solution. The formamide content, which is the pore promoter, was varied between 22 and 31 g. The membranes were characterized in terms of hydraulic permeability, salts rejection (NaCl, Na<sub>2</sub>SO<sub>4</sub> solutions with 600 ppm concentration), and Molecular Weight Cut-off (MWCO) (using different organic reference solutes, PEGs and Dextrans solutions with 1200 ppm). The extracts permeation experiments were carried out in total recirculation mode. The permeate fluxes were measured and samples of the feed and of the permeate were collected, and their clotting times were obtained. Concentration experiments were carried out with the membrane that presented the best enzyme rejection factor and best permeate fluxes.

16

[1] S. Gomes et al., Int. Dairy J. 91 (2019) 178-184.

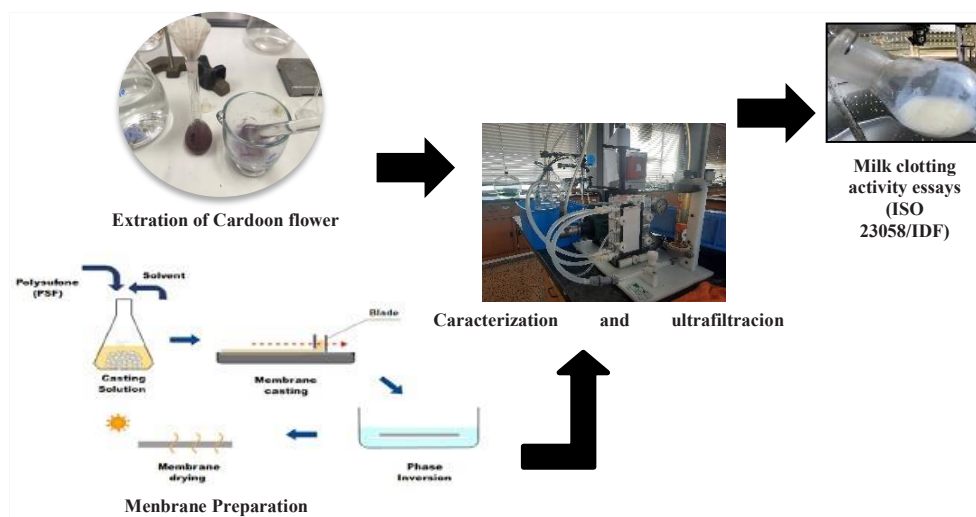

## KINETIC CHARACTERIZATION OF BIOCATALYSTS IN SYNTHESIS OF N-ACETYLNEURAMINIC ACID

**Mehmet Mervan Çakar<sup>1</sup>, Theofania Andreadaki<sup>2</sup>, Simon Charnock<sup>2</sup>, Wolf-Dieter Fessner<sup>3</sup>, Zvezdana Findrik Blažević<sup>1</sup>**

<sup>1</sup> University of Zagreb Faculty of Chemical Engineering and Technology, Savska c. 16, 10000, Zagreb, Croatia

<sup>2</sup> Prozomix Limited, Station Court, Haltwhistle, Northumberland, NE49 9HN, UK

<sup>3</sup> Institute of Organic Chemistry and Biochemistry, Technische Universität Darmstadt,

Alarich-Weiss-Strasse 4, 64287 Darmstadt, Germany

mmcakar@fkit.unizg.hr

Sialic acids (SAs), comprising over 50 distinct  $\alpha$ -keto acids found in viruses, mammalian cells, and microorganisms, play a crucial role in regulating diverse biological functions, including development, recognition, cell signaling, cell-cell interactions, and adhesion [1,2]. N-Acetylneuraminic acid (Neu5Ac), the most studied SA, can be synthesized by Neu5Ac synthase, catalyzing the aldol-like condensation of phosphoenolpyruvate (PEP) and N-Acetylmannosamine (ManNAc) to yield Neu5Ac. So far, the primary emphasis of the enzyme kinetic studies revolved around elucidating maximum reaction rates, catalytic constants, and Michaelis constants unique to PEP and ManNAc [3].

In this study, NeuB from *Neisseria meningitidis* and a promising NeuB homolog from a metagenomic library were evaluated as biocatalysts and exhaustive kinetic analyses were conducted in the synthesis of Neu5Ac (Scheme 1). This involved elucidating the effect of concentrations of substrates, metal cofactor, and product on the enzyme activity [4]. Additionally, bioinformatic analyses were utilized to obtain a comprehensive insight into the structure-function relationship of the promising NeuB homolog in our study and comparison with NeuB from *Neisseria meningitidis*.

[1] A. Varki, *Glycobiology* 3 (1993) 97–130.

[2] E. Gorelik et al., *Cancer Metastasis Rev.* 20 (2001) 245–277.

[3] T. O. Berg et al., *Carbohydr. Res.* 402 (2015) 133–145.

[4] D. Vasić-Rački, et al., *Appl. Microbiol. Biotechnol.* 91 (2011) 845–856.

17

This project has received funding from the European Union's Horizon 2020 research and innovation programme under the Marie Skłodowska-Curie grant agreement No 956631 (CC-TOP).

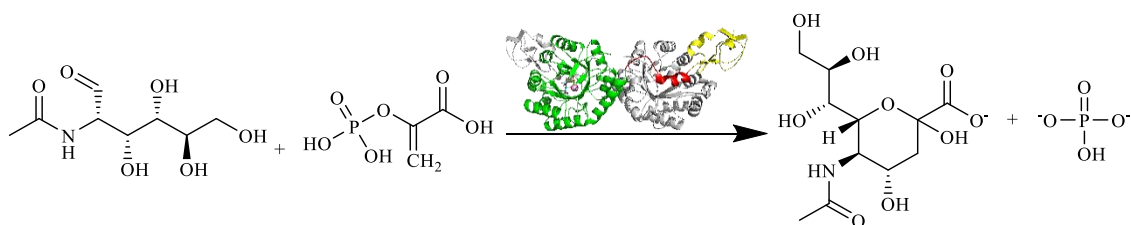

Figure 1. NeuS catalyzed Neu5Ac synthesis from ManNAc and PEP via aldol-like addition

# SPATIALLY CONTROLLING THE MECHANICAL PROPERTIES OF 3D PRINTED OBJECTS BY DUAL-WAVELENGTH DIGITAL LIGHT PROCESSING

**Ines Cazin<sup>1</sup>, Milena Olga Gleirscher<sup>1</sup>, Mathias Fleisch<sup>1</sup>, Marco Sangermano<sup>2</sup>, Sandra Schlögl<sup>1</sup>**

<sup>1</sup>Polymer Competence Center Leoben GmbH, Leoben, Austria

<sup>2</sup>Department of Applied Science and Technology, Politecnico di Torino, Torino, Italy  
ines.cazin@gmail.com

To date, the 3D printing of polymers with heterogeneous and locally controlled material properties is still a challenging area in additive manufacturing. In terms of digital light processing (DLP) 3D printing, the fabrication of multi-material objects typically relies on an automatic material exchange of different resin vats. However, along with the high complexity of the printing equipment, this technique suffers from a low build speed and often yields 3D printed objects with weak interlayer adhesion across the various material interfaces. Herein, we use chemo-selective wavelengths to fabricate objects with multi-material properties by dual-wavelength DLP 3D printing employing a single vat. The photopolymers' stiffness and flexibility are conveniently controlled by two photoreactions working at two different wavelengths. In particular, a dual photocurable resin is applied containing multi-functional acrylates, which are cured by a radical induced chain growth reaction at 405 nm, and bi-functional epoxy monomers, which additionally undergo cationic curing upon UV exposure (365 nm). FT-IR experiments confirm the wavelength selective network formation whilst dynamic mechanical analysis and tensile tests give evidence of the distinctive difference of the related mechanical properties. By being able to produce soft ( $E'(25^\circ\text{C}) = 15 \text{ MPa}$ ) and stiff ( $E'(25^\circ\text{C}) = 1.98 \text{ GPa}$ ) networks with a single resin vat, we demonstrate the efficient fabrication of 3D structures with locally controlled mechanical properties using a dual-wavelength 3D printer operating at 405 and 365 nm. In contrast to previous work in this field, we were able to significantly expand the range of mechanical properties by appropriate selection of the acrylic components and to drastically accelerate the build speed by changing the cationic photoinitiator and using a customized DLP printer with high intensity LED sources [1].

[1] I. Cazin et al., *Addit. Manuf.* 57 (2022) 102977.

18

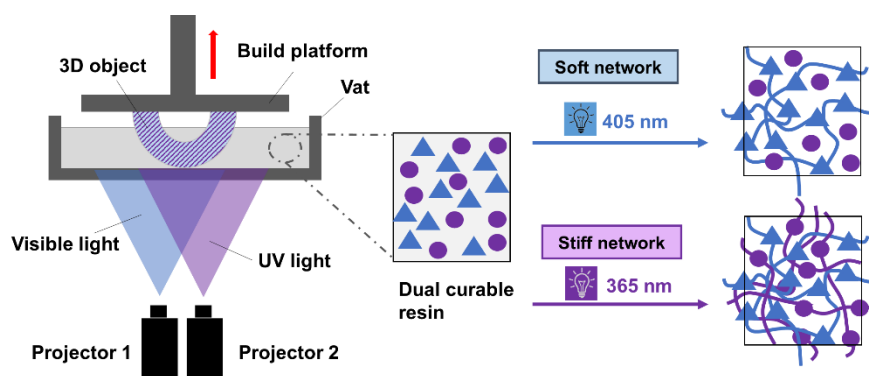

Figure 1. Schematic representation of the dual-wavelength DLP printer and the wavelength selective formation of soft and stiff domains

## CHITOSAN/BIOACTIVE GLASS SCAFFOLDS AS POTENTIAL DRUG CARRIERS

**Luka Dornjak, Anamarija Rogina**

University of Zagreb Faculty of Chemical Engineering and Technology, Trg Marka Marulića 19, 10000 Zagreb, Croatia  
ldornjak@fkit.unizg.hr

Doxorubicin (DOX), a potent chemotherapeutic agent, is versatile and chemotherapeutic medium used in the treatment of various forms of sarcomas such as breast, prostate, uterus, stomach, liver, osteosarcoma, and soft tissue sarcomas. The anticancer activity of DOX is due to its intercalation with DNA resulting in rapid DNA degeneration and cancer cell apoptosis. Despite its effectiveness, DOX is associated with potential side effects, including permanent damage to the heart, brain, liver, and kidneys, leading to cardiotoxicity and even lowering of cognitive scores, inhibition of self-regeneration and nephropathy. To overcome this, a localized administration could be a solution to avoid unintended damage to the body caused by intravenous administration [1]. Biodegradable polymeric drug carriers showed good potential for targeted drug delivery. Chitosan represents a biocompatible and biodegradable polysaccharide which has garnered significant attention for application within the fields of biomedicine and pharmacy. Owing to its unique molecular structure, chitosan possesses intrinsic polycationic properties allowing for complex formation with biological macromolecules such as proteins and lipids. Moreover, due to its specific functional groups, chitosan also provides antibacterial, hemostatic and analgesic properties making it suitable for various biomedical applications [2,3]. The presence of bioactive glass (BG) within the chitosan matrix could enhance drug incorporation and influence the release kinetics of doxorubicin from a polymer-based carrier. Bioactive glass belongs to bioactive bioresorbable materials with the ability to induce the formation of bone-like apatite and it is frequently applied in bone tissue engineering [4]. In the form of highly porous structures, chitosan/BG scaffolds provide good support for the adsorption of doxorubicin and further bone regeneration, facilitating drug release by the scaffold degradation and resorption. Such a composite offers sustained drug release while minimizing systemic exposure and potential side effects [5].

This work aimed to prepare chitosan/BG composite scaffolds as biodegradable doxorubicin carriers for bone tumour treatment. The composite scaffolds were prepared at different weight fractions of bioactive glass (0 – 30%) within the chitosan matrix by thermally induced phase separation and subsequent solvent sublimation. Obtained composite scaffolds were characterized by X-ray diffraction (XRD), Fourier transformation infrared spectroscopy (FTIR) and scanning electron microscopy (SEM) assisted with energy-dispersive X-ray spectroscopy (EDS). The drug was loaded through a simple immersion of prepared scaffolds into doxorubicin solution at different concentrations (25 and 50 ppm) for 5 h. The loading efficacy was determined by fluorescence method before and after scaffold immersion, while the release of doxorubicin was investigated in phosphate buffer solution (PB, pH 7.4) during 24 h.

19

- [1] C. Carvalho et al., *Curr. Med. Chem.* 16 (2009) 3267–3285
- [2] K. Prusty et al., *Nanostructured Polymer Composites for Biomedical Applications*, Elsevier (2019), pp. 295–314
- [3] B. Yang et al., *Carbohydr. Polym.* 80 (2010) 860–865
- [4] Skwira, Adrianna et al., *Int. J. Pharm.* 633 (2023): 122610.
- [5] C. Wu et al., *Ther. Deliv.* 2 (2011) 1189–1198

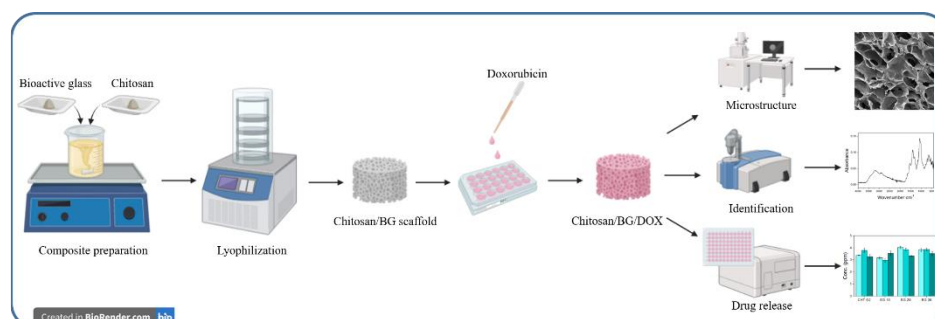



## DIGITALNI BLIZANAC INDUSTRIJSKOG POSTROJENJA

### DIGITAL TWIN OF AN INDUSTRIAL PLANT

**David Fabek**

Siemens d.d., Digital Industries, 10000 Zagreb, Hrvatska  
david.fabek@siemens.com

U proteklim godinama, industrija se radikalno transformirala pod utjecajem koncepta Industrije 4.0, ostvarujući značajan napredak u proizvodnim procesima. Temelj ove revolucije leži u konceptu digitalnog blizanca, koji predstavlja virtualnu repliku fizičkog objekta, sustava ili procesa. Digitalni blizanci mogu se opisati kao most između fizičkog i digitalnog svijeta. Njihova primjena u kemijskoj industriji donosi niz ključnih prednosti poput detaljnog praćenja procesa, uvida u učinkovitost procesa te predviđanja i sprječavanja potencijalnih problema, osiguravajući tako maksimalnu efikasnost, smanjenje troškova i povećanje kvalitete krajnjeg proizvoda. Digitalni blizanci predstavljaju moćan alat za optimizaciju postrojenja, platformu za eksperimentiranje i razvoj inovacija te obuku operatora.

Ovim radom razvijen je digitalni bliznac dijela industrijskog postrojenja koji se sastoji od bioreaktora, separacije fermentacijom proizvedenih bakterija te linije za dezinfekciju i čišćenje reaktora. Razvoj digitalnog blizanca i istraživanje provedeno je primjenom Siemensovih alata PCS neo i SIMIT Simulation Platform. Programskim alatom PCS neo konfiguriran je sustav za vođenje, nadzor i dijagnostiku procesa te su definirani parametri za različite faze rada postrojenja. Programskim alatom SIMIT SP stvoreno je virtualno okruženje za simulaciju rada postrojenja i optimizaciju parametara procesa.



## CHALLENGES OF GLASS AS A PRIMARY PACKAGING MATERIAL FOR BLACK ALKALINE STERILE FORMULATION

**Mateja Filković<sup>1</sup>, Maja Mihoci<sup>1</sup>, Tea Mihelj Josipović<sup>1</sup>,  
Iva Perić<sup>1</sup>, Domagoj Vrsaljko<sup>2</sup>**

<sup>1</sup>PLIVA Hrvatska d.o.o., 10000 Zagreb, Croatia

<sup>2</sup>University of Zagreb Faculty of Chemical Engineering and Technology, 10000 Zagreb, Croatia  
mateja.filkovic@pliva.com

Glass is the most widely used packaging material for parenteral formulations. It is currently the preferred material due to its chemical and physical inertness. Although this assumption is generally true, glass is both chemically and physically reactive under certain conditions. Aqueous solutions can interact with glass and lead to the formation of glass-based particles. This process, commonly known as glass delamination, is accelerated by solutions containing various anions, especially under alkaline conditions or at high temperatures. The delamination of glass surfaces with chemical heterogeneity can be detected by the formation of a surface "skin" during processing, the extraction of soluble species (alkalis and borates) and the swelling of the silica-containing "skin" by hydration. The final and most conclusive confirmation of delamination is the release of the swollen layer as delaminated flakes [1]. Delamination is a matter of time, and glass particles may only occur after months or years of product storage. When delamination is observed in a vial, it is assumed to occur primarily in areas where heat was applied during the manufacture of the vial, i.e. the bottom and shoulder of a vial [2]. These areas have a lower hydrolytic and chemical resistance and form so-called reaction zones when in contact with the product [3]. It is assumed that the mechanism of glass dissolution changes at higher pH values from the leaching of alkali elements to the dissociation of the silicate network [3]. Since the glass delamination is time-dependent, the study was carried out under accelerated stability conditions. A black alkaline solution with a pH value of 10.9 was filled into standard type I vials and stored at 25 °C and 40 °C. Glass delamination in each of the containers was assessed by filtering the solution using a polycarbonate filter and observing the glass flakes with a stereomicroscope. Particulates identified as glass were subjected to elemental analysis and particle identification by scanning electron microscopy with energy dispersive X-ray spectroscopy (SEM-EDS). The presence of sodium, oxygen, aluminum and silicon was taken as an indication of delamination. The inner surface of the vial was characterized by colorimetric staining and scanning electron microscopy (SEM) after a special stress treatment to identify its potential inhomogeneity. Delamination was observed in all three parts of the inner surface of the vial - top, middle and bottom. The delamination of the inner glass surface was most pronounced in the bottom part of the vial, where the delamination zone and delamination in the form of "flakes" and deposits of particles as well as a rough, inhomogeneous surface were observed. At the top and middle part of the vial, delamination is present in the form of particle deposits, a rough, inhomogeneous surface and shallow pits.

21

- [1] <https://www.corning.com/worldwide/en/products/pharmaceutical-technologies/pharma-technologies-delamination.html>  
 [2] V. Rupertus et al., PDA J. Pharma. Sci. Technol. 68 (2014) 373-380.  
 [3] D. Ditter et al., J. Pharm. Sci. 107 (2018) 624-637.

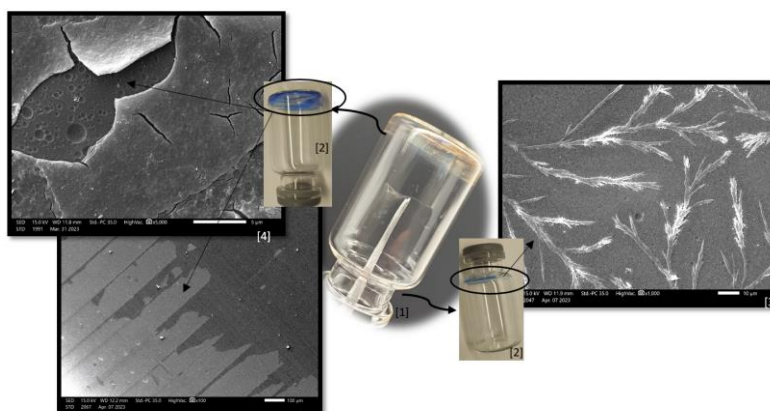

Figure 1. Empty vial after 6 months of stress test filled with black alkaline solution [1]; vial after colorimetric staining with methylene blue, coloured delaminated areas [2]; SEM images of the top/shoulder [3] and bottom [4] part of the vials.

# THE INFLUENCE OF THE STRUCTURE OF BRANCHED ISOMER OF SELECTED HIGHER ALCOHOL AND REACTION PARAMETERS ON BIODIESEL SYNTHESIS FROM WASTE COOKING OIL

**Mia Gotovuša<sup>1</sup>, Paula Huzjak<sup>1</sup>, Marta Krasić<sup>1</sup>, Martina Zadravec<sup>1</sup>, Jelena Parlov Vuković<sup>2</sup>, Fabio Faraguna<sup>1</sup>**

<sup>1</sup>University of Zagreb Faculty of Chemical Engineering and Technology, Trg Marka Marulića 19, 10000 Zagreb, Croatia

<sup>2</sup>Ruđer Bošković Institute, Bijenička cesta 54, 10000 Zagreb, Croatia  
mgotovusa@fkit.unizg.hr

Biodiesel or fatty acid alkyl esters, are most commonly synthesized via transesterification reaction of a certain source of triglycerides (vegetable oils or animal fats), and an alcohol (commercially, methanol or ethanol), in the presence of a catalyst [1]. Nowadays, research in the field of biofuels focuses on the application of isomers from higher alcohols, either straight-chained or branched, due to their multiple advantages in comparison to the most commonly used ones. The use of higher and branched alcohol isomers in the biodiesel synthesis can improve some of the biodiesel's application properties, e.g. cetane number that increases with the increase in alkyl chain length [2] or low-temperature properties that improve in the presence of structural branching [3]. In this research, biodiesel was synthesized from waste cooking oil, and a selected higher alcohol isomer (1-butanol, isobutanol, 2-butanol, 1-pentanol, isopentanol, 2-pentanol), in a presence of potassium hydroxide. The influence of four reaction parameters (reaction temperature, time, molar ratio of the reactants, and mass fraction of the catalyst) on reaction conversion of each of these reaction systems was studied. The results showed that the most significant reaction parameters were the molar ratio of the reactants, and the mass fraction of the catalyst. Additionally, the use of branched alcohol isomers in transesterification reactions lowered the reaction conversion, due to the present steric hindrance.

- [1] E. M. Shahid et al., *Renew. Sust. Energ. Rev.* 15 (2011) 4732-4745.  
[2] K. Wadumesthrige et al., *J. Am. Oil Chem. Soc.* 85 (2008) 1073-1081.  
[3] P. C. Smith et al., *Renew. Energ.* 35 (2010) 1145-1151.

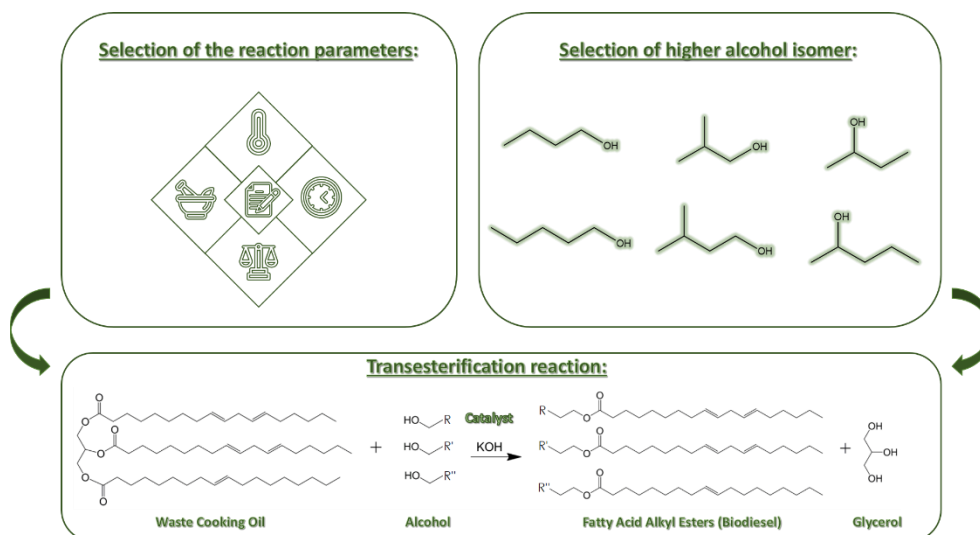

## SYNTHESIS OF POLYAMIDO-SILOXANES

**Danica Jovašević**

University of Novi Sad, Faculty of Technology, Bulevar cara Lazara br.1, 21 000 Novi Sad, Serbia  
jovasevic.danica@gmail.com

The rapid development of technology in recent decades has sparked a great demand for innovative materials with enhanced properties, emphasizing the energy efficiency of the formulation of these materials. Among the new generations of materials, the greatest focus is on hybrid materials, especially hybrid copolymers that combine specific characteristics of different types of polymers. Polymers based on polyurethane and polysiloxane are good examples of hybrid copolymeric materials, thanks to the mechanical strength derived from the hard segments of diisocyanates and the thermal stability and flexibility resulting from the presence of soft siloxane segments. The complementary properties of this copolymer have led to its application in medical and construction industries, the adhesive industry, as well as in paint and coating industry. In the existing literature, there has been no mention of the polymerization of diisocyanates and siloxanes without the use of chain extenders or functionalized siloxanes or isocyanates. However, potential directions for the development of alternative materials and insights into the advantages of combining these two prepolymers have been presented. The aim of this work is the synthesis of polyamide-siloxane networks through the polymerization of different types of diisocyanates with H-terminated siloxane. The preparation of samples involved adding the appropriate diisocyanate (methylene diphenyl diisocyanate – MDI, toluene diisocyanate – TDI, isophorone diisocyanate – IPDI) to sililidine, so that the ratio of SiH:NCO groups is 1:2. Polymerization was carried out in microwave reactor with the addition of dibutyl dilaurate as a catalyst. The obtained amido-siloxanes were characterized using Fourier-transform infrared spectroscopy (FTIR) and differential scanning calorimetry (DSC). FTIR spectroscopy results showed characteristic peaks of the amide bond, confirming the assumed structure of the obtained network. Additionally, new peaks with wavelengths not standardized for any existing compound appeared, indicating the formation of a new, hybrid prepolymer. Differential scanning calorimetry confirmed that the choice of diisocyanates affects the orderliness of the structure and the thermal properties of the obtained prepolymers. In conclusion, it can be inferred that the reaction of diisocyanates with H-terminated siloxane was successful but leaves room for the optimization of the synthesis process to form a prepolymer that can be tested for various applications, with a focus on medical use.

## KOMPLEKSIRANJE ALKALIJSKIH I ZEMNOALKALIJSKIH KATIONA S TERCIJARNIM AMIDNIM DERIVATOM KALIKS[6]ARENA

### COMPLEXATION OF ALKALI AND ALKALINE EARTH METAL CATIONS BY TERTIARY-AMIDE CALIX[6]ARENE DERIVATIVE

**Karla Kukina Gradečak, Katarina Leko, Andrea Usenik, Nikola Cindro,  
Vladislav Tomišić**

Sveučilište u Zagrebu Prirodoslovno-matematički fakultet, Kemijski odsjek, 10000 Zagreb, Hrvatska  
karla.kukinagradecak@chem.pmf.hr

Kaliks[*n*]areni su makrociklički spojevi koji sadrže fenolne podjedinice ( $n \geq 4$ ) povezane metilenskim mostovima u *ortho* položaju. [1] Njihov gornji i/ili donji obod može se funkcionalizirati, a ovisno o uvedenim funkcijskim skupinama, derivati kaliksarena mogu biti vrlo dobri receptori za razne kemijske vrste. Tako se uvođenjem elektron-donirajućih skupina, poput esterskih, ketonskih ili amidnih, na donji obod kaliksarena dobivaju efikasni, a ponekad i selektivni receptori kationa. [1–7] Iako su kaliksareni vrlo često proučavani receptori, većina istraživanja odnosi se na kaliks[4]arene, dok su ona vezana uz kaliks[6]arene puno manje zastupljena.

U ovom radu istražene su reakcije kompleksiranja alkalijskih i zemnoalkalijskih kationa s tercijarnim amidnim derivatom kaliks[6]arena **L** acetonitrilu. Termodinamika nastajanja kompleksa stehiometrije 1:1 i 2:1 (kation:ligand) istražena je pomoću izotermne titracijske kalorimetrije, spektrofotometrije, NMR spektroskopije i fluorimetrije. Dobiveni rezultati diskutirani su s obzirom na strukturne karakteristike makrocikličkog receptora te veličinu i gustoću naboja kationa.

- [1] C. D. Gutsche, Calixarenes: An Introduction, The Royal Society of Chemistry, Cambridge (2008).
- [2] A. F. Danil de Namor et al., Chem. Rev. 98 (1998) 2495–2525.
- [3] B. S. Creaven et al., Coord. Chem. Rev. 253 (2009) 893–962.
- [4] J. Požar et al., J. Phys. Chem. B 121 (2017) 8539–8550.
- [5] N. Cindro et al., Org. Biomol. Chem. 16 (2018) 904–912.
- [6] J. Požar et al., Molecules 27 (2022) 470.
- [7] K. Leko, A. Usenik et al., ACS Omega 8 (2023) 43074.

Istraživanje je provedeno u okviru projekta koji financira Hrvatska naklada za znanost pod nazivom MacroSol (IP-2019-04-9560) i podržano je Europskim fondom za regionalni razvoj (projekt CluK, KK.01.1.1.02.0016).

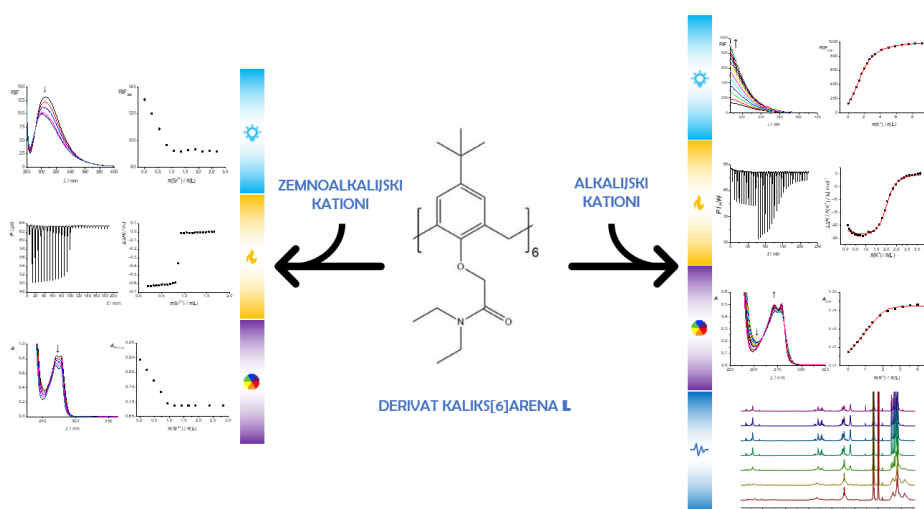

## DEVELOPMENT OF AN INTEGRATED MILLISYSTEM FOR CONTINUOUS SYNTHESIS AND SEPARATION OF RESVERATROL ANALOGUES

**Anabela Ljubić<sup>1</sup>, Ivan Karlo Cingesar<sup>2</sup>, Domagoj Vrsaljko<sup>2</sup>,  
Anita Šalić<sup>2</sup>, Irena Škorić<sup>2</sup>**

<sup>1</sup>Teva API R&D, Pliva Croatia d.o.o., Prilaz baruna Filipovića 25, 10000 Zagreb, Croatia

<sup>2</sup>University of Zagreb Faculty of Chemical Engineering and Technology, Trg Marka Marulića 19, 10000 Zagreb, Croatia

Anabela.Ljubic@pliva.com

Nowadays, resveratrol and its analogues have attracted much attention due to their potential use in prevention and therapy of various diseases. Some of the bioactivities reported for these compounds have antioxidant, antimicrobial, neuroprotective, and anticancer activity [1,2]. Currently, chemical synthesis is the preferred route to obtain larger quantities of stilbene-like compounds and it usually involves the Wittig reaction. The classical Wittig reaction requires the use of strong bases, which are often dangerous, expensive, and sensitive to water [2]. These disadvantages can be avoided by implementation of phase-transfer catalysis (PTC). The PTC Wittig reaction is performed in a two-phase system consisting of an organic and an aqueous phase in the presence of a widely available and cheap base such as sodium hydroxide (NaOH). The mentioned approach for the Wittig reaction opens up possibilities for further improvements in terms of environmental friendliness and productivity [3]. The, organic phase solvents in the PTC Wittig reaction, such as hazardous dichloromethane (DCM), can be replaced by natural deep eutectic solvents (NADES) from naturally occurring compounds. Additionally, the reaction can be carried out in continuous flow reactors, which often significantly improves mass transfer in multiphase systems and thus increases process efficiency. In this research, an integrated resveratrol production process, consisting of the PTC Wittig reaction and product separation, was carried out in a millireactor and a milliseparator connected in series. The PTC Wittig reaction was carried out using a hydrophobic NADES as the reaction solvent in order to develop a safer and more sustainable production process. The effects of temperature and residence time on the synthesis and separation of resveratrol were investigated to find the best process conditions. In the end, the results obtained were compared with the results of the reaction using DCM as a conventional solvent and the best process was proposed.

25

- [1] M. Mlakić et al., J. Flow Chem. 12 (2022) 429-440.  
[2] A. Ljubić et al., ChemistrySelect 8 (2023) e202303375.  
[3] E. Šinkovec et al., Org. Process Res. Des. 15 (2011) 817-823.

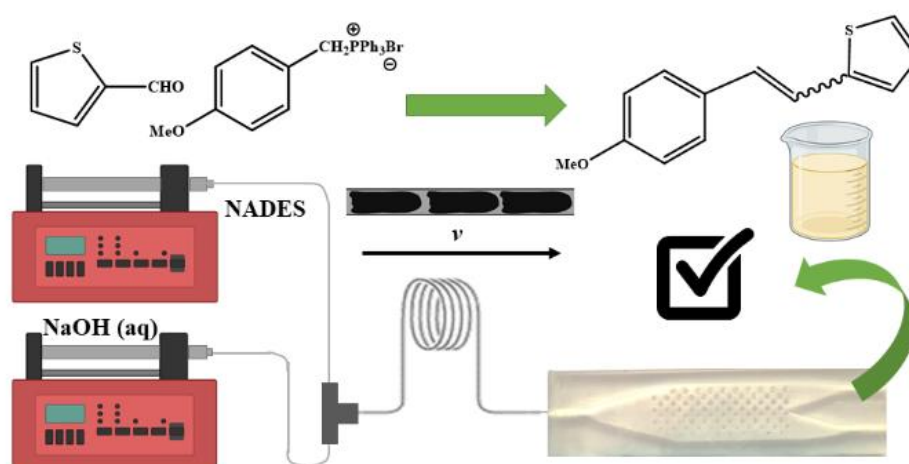

## THE SIGNIFICANCE OF CHOLESTEROL FOR MYELIN LIPID PHASES

**Petra Maleš, Danijela Bakarić**

Ruder Bošković Institute, Division of Organic Chemistry and Biochemistry, Bijenička Cesta 54, 10000 Zagreb, Croatia  
pmales@irb.hr

The overall structure of the multilayered myelin membrane responsible for efficient transmission of nerve impulses depends on the ratio of constitutive lipids, as well as on their interactions with myelin basic protein (MBP), an intrinsically disordered protein whose basic function is the adhesion of adjacent myelin layers [1]. In the non-homogenous layers of myelin, domains of cholesterol, as well as phospholipids, contribute myelin formation and stabilization [2]. There is much evidence for the importance of cholesterol (Chol) in myelin, including the possibility that cholesterol influences the repair of damaged myelin in pathological conditions such as in autoimmune disease multiple sclerosis [3].

Despite the many biological studies carried out, the impact of cholesterol on domains composed of other lipids in myelin at the molecular level is completely unclear. Therefore, this research addressed the characterization model myelin membranes in the presence and absence of cholesterol. Accordingly, multilamellar liposomes (MLVs) with different ratios of myelin lipids ((phosphatidylcholine (PC), phosphatidylethanolamine (PE), phosphatidylserine (PS), sphingomyelin (SM)) with/without Chol were prepared and used to mimic myelin at physiological and pathological conditions [4]. Using calorimetric (DSC) and spectroscopic techniques (UV-Vis, FTIR and CD), the changes in lipid domains, as a function of Chol, were identified and discussed in terms of the temperatures corresponding to different phases of constitutive myelin lipids [5].

- [1] Y. Min et al., PNAS 106 (9) (2009), 3154–3159.
- [2] Simons et al., J. Cell Biol. 151 (2000), 143–154.
- [3] S.A. Berghoff et. al., TINS 45 (2022) 272–283.
- [4] R. Shaharabani et al., PNAS 115 (2018), 11156–11161.
- [5] P. Maleš et al., SAA (2022) 121013.

This work was financed within the project „Model of demyelination on a molecular scale at physiological and pathological conditions“ (Croatian Science Foundation, UIP-2020-02-7669).

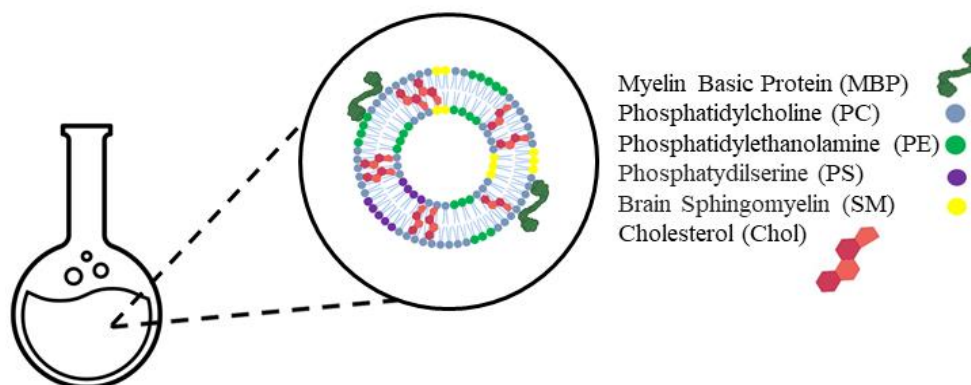

Figure 1. The scheme of the flask with model myelin lipids with myelin basic protein (MBP).

## KRISTALI IZLOŽENI MEHANIČKOM STRESU: OTKRIVANJE FLEKSIBILNIH ODZIVA

### CRYSTALS UNDER MECHANICAL STRESS: UNRAVELING FLEXIBLE RESPONSIVENESS

**Antonio Močinić, Ozana Mišura, Marijana Đaković**

University of Zagreb Faculty of Science, Department of Chemistry, Horvatovac 102a, 10000 Zagreb, Croatia  
antonio.mocinic@student.pmf.hr

Although crystals and crystalline materials are indispensable in modern technology, their application is often limited due to brittleness, which has been typically considered as their inherent characteristic. Recently, it has been discovered that molecular crystals, when subjected to light, heat, or electromagnetic radiation, may show remarkable features, such as a diverse array of mechanically flexible responses, including both elastic and plastic flexibility. Even though flexible responses of organic molecular solids has been substantially researched, considerably fewer examples of metal-organic crystals showcase light- or heat-stimulated, or even mechanically induced adaptability.[1] Furthermore, a breakthrough research provided insight into flexible mechanical responsiveness of coordination polymer crystals whereas with just a minor structural alteration, a series of diverse elastic responses were displayed in response to external mechanical stimuli.[2] Furthermore, recently it has also been reported that a suboptimal elastic performance can be improved by strengthening the weakest link in the crystal structure.[3] Coordination polymers are notable structural systems for examining material characteristics as they often yield groups of isostructural compounds where by introducing small structural changes in a systematic manner their mechanical responses can consequently be systematically mapped and compared. To gain a deeper insight into the recently observed mechanical behaviours of metal-containing crystalline solids, we opted to study flexible responses of crystals with copper(II) bromide bearing the halopyridine functionality. Crystals, prepared *via* liquid diffusion, were isolated with respect to SCXRD (single-crystal X-ray diffraction) and bending-experiments quality, and subjected to mechanical stress. Mechanical responses were analysed with respect to the type of flexibility and the crystal faces on which the mechanical force was applied. The elucidation of mechanical behaviour was further contextualized in relation to structural features.

27

- [1] P. Commins et al., *Chem. Commun.* 52 (2016) 13941-13954.  
[2] M. Đaković et al., *Angew. Chem. Int. Ed. Engl.* 57 (2018) 14801-14805.  
[3] O. Mišura et al., *Cryst. Growth Des.* 23 (2023) 1318-1322.

This work has been fully supported by the Croatian Science Foundation under project IP-2019-04-1242.





## SOL-GEL METODA PRIPREME pH-SENZORSKIH FILMOVA NA OSNOVI LAKMUSA ZA PRIMJENU U MIKROREAKTORIMA

### PREPARATION OF pH SENSOR FILMS BASED ON LITMUS BY THE SOL-GEL METHOD FOR THE APPLICATION IN MICROREACTORS

**Andela Nosić, Marijan-Pere Marković, Domagoj Vrsaljko**

Sveučilište u Zagrebu Fakultet kemijskog inženjerstva i tehnologije, Trg Marka Marulića 19, 10000 Zagreb, Hrvatska  
anosic@fkit.unizg.hr

Sol-gel metoda je izabrana kao način pripreme pH-senzorskih filmova. Kao prekursori su korišteni tetraetoksisilan (TEOS) i feniltrimetoksisilan (FTMS), a kao pH indikator korišten je lakmus. Mikroreaktori su 3D-ispisani od poli(etilen-tereftalata) obogaćenog glikolom (PETG). Za izradu se koristila vrsta aditivne tehnologije pod nazivom proizvodnja rastaljenim filamentom (eng. *Fused Filament Fabrication, FFF*).

Ciljevi ovog rada su utvrditi radno područje pH indikatora nakon imobilizacije i utvrditi efikasnost miješanja mikroreaktora prateći promjenu boje senzorskog filma. Izrađena su tri modela mikroreaktora. Jedan od modela je obični cijevni reaktor, a druga dva imaju statičke miješalice koje utječu na tok fluida koji prolazi kroz reaktor. Miješanje se pratilo reakcijom neutralizacije klorovodične kiseline (HCl) i natrijevog hidroksida (NaOH).

Istraživanja na pločicama od PETG-a su pokazala da se pH-senzorski film na osnovi lakmusa uspješno priprema sol-gel metodom. Do promjene boje pH-senzorskog filma iz crvene u plavu dolazi u otopini čija je pH-vrijednost devet. Senzorski filmovi su homogeni i njihova adhezija sa supstratom je dobra. Različiti tipovi mikroreaktora su imali različitu efikasnost miješanja.

Ovaj rad sufinancirala je Hrvatska zaklada za znanost projektima IP-2022-10-8004 (INDIGO) i DOK-2021-02-5999.

pH-senzorski filmovi na pločicama od PETG-a



Cijevni mikroreaktor

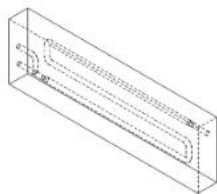

Mikroreaktori sa statičkim miješalicama

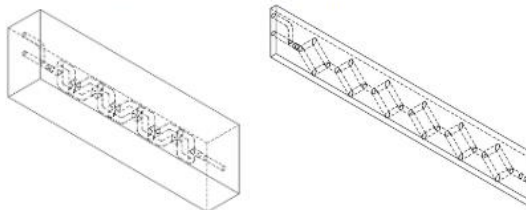

## SKRIVENO U PODACIMA: MJERENJE NEMJERLJIVOGA HIDDEN IN THE DATA: MEASURING THE UNMEASURABLE

**Nikola Rimac, Željka Ujević Andrijić**

Sveučilište u Zagrebu Fakultet kemijskog inženjerstva i tehnologije, Trg Marka Marulića 19, 10000 Zagreb, Hrvatska  
nrimac@fkit.unizg.hr

S dostupnošću sve jače računalne opreme modeli strojnoga učenja se naširoko primjenjuju u kemijskom inženjerstvu, a posebice kod preventivne i prediktivne dijagnostike procesa i procesne opreme [1]. Takvi su modeli jednostavni za implementaciju u informacijski sustav, jer daju matematički opis procesa, iziskujući pri tom minimalnu potrebu za fundamentalnim znanjem o procesu [2]. Međutim, glavni je razlog korištenja naprednih modela taj što je razvoj fundamentalnih modela za neke procese vrlo kompleksan, gotovo nemoguć, zbog složene prirode samoga procesa [1]. Rezultat modela temeljenoga na podacima ne daje fizikalni uvid u mehanizam procesa, ali je često dovoljan za opisivanje odnosa ulaznih i izlaznih varijabli procesa [3]. U ovome radu je prikazan razvoj naprednih modela za praćenje nastajanja naslaga u izmjenjivačima topline u naftnoj industriji. Inspiracija za navedenu temu je proistekla iz činjenice da su dinamički procesni uvjeti i različita svojstva sirove nafte često u odmaku od projektiranih uvjeta, a mehanizmi nastanka naslaga još uvijek nedovoljno istraženi [4]. U ovome radu prikazan je razvoj *data-driven* modela strojnoga učenja u kombinaciji s kemijsko-inženjerskim znanjem u svrhu identifikacije i praćenja nastanka naslaga, odnosno pada efikasnosti realnog industrijskog izmjenjivača topline. Prema realnim podacima prikupljenih s postrojenja te laboratorijskim ispitivanjima svojstava nafte, razvijani su modeli statičkih i dinamičkih neuronskih mreža. Navedeni modeli su razvijeni u svrhu predviđanja rada izmjenjivača topline kakav bi bio da je čist odnosno bez naslaga, u cijelom periodu rada, tj. od pokretanja do gašenja proizvodnje radi remonta. Rezultati takvih modela, uz termodinamičke jednadžbe i geometriju izmjenjivača, temelj su za izračun pada efikasnosti izmjenjivača topline uslijed nastanka naslaga. Informacija o postepenom padu te dinamici nastajanja naslaga uslijed primjene različitih vrsta sirove nafte omogućuje tehnolozima da pravovremeno odluče te reagiraju s ciljem optimalnog vođenja procesa i održavanja potrebne kvalitete proizvoda. Predobrada prikupljenih podataka i odabir ulaznih varijabli, kao i razvoj i vrednovanje modela izrađeni su u programskom jeziku *Python* s pripadajućim bibliotekama.

29

- [1] N. Md Nor et al., Rev. Chem. Eng. 36 (2020) 513-553.
- [2] K. Tidriri et al., Annu. Rev. Control. 42 (2016) 63-81.
- [3] Ž. Ujević Andrijić et al., Heat Transf. Eng. 43 (2022) 1852-1866.
- [4] S. Emani et al., E3S Web Conf. 287 (2021) 03003.

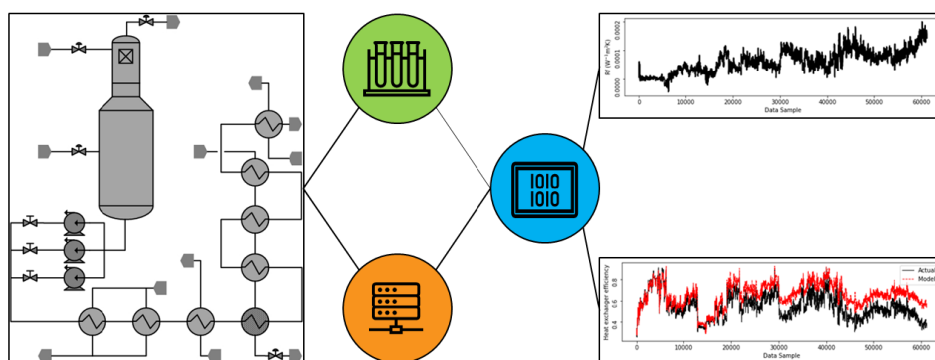

## IMPACT OF MORINGA EXTRACT (*Moringa oleifera*) ON THE FERMENTATION PROCESS OF GOAT MILK

**Petra Roksandić, Irena Barukčić Jurina, Rajka Božanić, Katarina Lisak Jakopović**

University of Zagreb Faculty of Food Technology and Biotechnology, Pierottijeva 6, 10000 Zagreb, Croatia  
proksandic123@gmail.com

Functional products are increasingly prevalent in the human diet due to their positive impact on human health. Nowadays, research on the possibility of producing fermented milk drinks with the addition of plant extracts is becoming more common. *Moringa oleifera* is a plant from which an extremely rich nutrient extract containing vitamins, minerals, polyphenols, and antioxidants is obtained, making it suitable for enriching dairy products [1]. Goat milk is a rich source of all nutritional components, and due to the different composition of milk fat and proteins, it is more digestible than cow's milk. It is used as a remedy for regulating cholesterol levels in the blood, protecting against cardiovascular diseases, reducing blood pressure, alleviating bronchitis and asthma, gallbladder and gallstone-related conditions, and reducing the risk of type 2 diabetes [2]. The aim of this study was to produce yogurt with the addition of moringa extract (1, 3 and 5 %) and to assess its impact on the fermentation time and the proliferation of yogurt culture (*Lactobacillus delbrueckii* subsp. *bulgaricus* and *Streptococcus thermophilus*) during the fermentation process. Microbiological and physicochemical analyses were conducted throughout the fermentation process. The research results indicate that adding moringa extract to goat's milk shortens the fermentation time, positively affecting the growth and development of yogurt culture.

[1] K. Lisak Jakopović et al., *Ferment.* 8 (2022) 545-562.

[2] S. Verruck et al., *J. Funct. Foods* 52 (2019) 243-257.

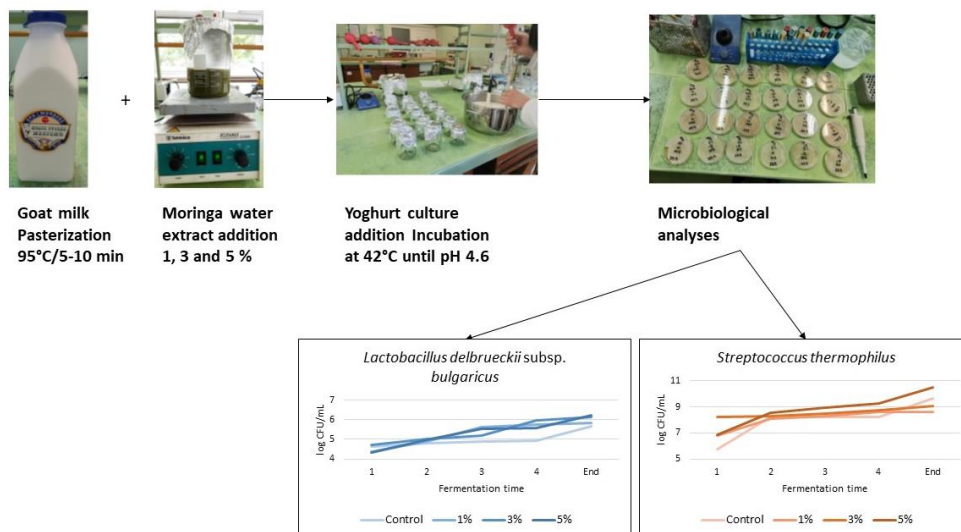

## SOLVENT-FREE MECHANOCHEMICAL SYNTHESIS OF DASATINIB-CYCLODEXTRIN INCLUSION COMPLEXES – COMPUTATIONAL AND EXPERIMENTAL STUDY

**Katarina Sokač<sup>1</sup>, Lucija Vrban<sup>2</sup>, Robert Vianello<sup>2</sup>, Irena Škorić<sup>1</sup>, Krunoslav Žižek<sup>1</sup>**

<sup>1</sup>University of Zagreb Faculty of Chemical Engineering and Technology, Trg Marka Marulića 19, 10000 Zagreb, Croatia

<sup>2</sup>Laboratory for the Computational Design and Synthesis of Functional Materials, Ruđer Bošković Institute, Bijenička cesta 54, 10000 Zagreb, Croatia  
ksokac@fkit.unizg.hr

Dasatinib (DAS), an anticancer drug facing challenges such as high first-pass metabolism, poor absorption, and low oral bioavailability, underwent formulation enhancement. To investigate the potential formation of inclusion complexes of DAS with various cyclodextrins through co-grinding and evaluate the potential effect on solubility improvement of the resulting complexes in water, a series of computational simulations were conducted. These involved a range of molecular dynamics simulations aimed at inspecting interactions between DAS and cyclodextrins in the gas phase, thus mirroring experimental conditions without the presence of a solvent.

In the experimental study,  $\beta$ -cyclodextrin ( $\beta$ -CD) and hydroxypropyl- $\beta$ -cyclodextrin (HP- $\beta$ -CD) were used. These macrocyclic receptors are highly versatile, exhibiting multifunctional attributes, and are primarily used to enhance the physicochemical stability, solubility, dissolution rate, and bioavailability of pharmaceuticals. The solvent-free co-grinding method in a planetary ball mill was used for the synthesis of inclusion complexes of  $\beta$ -CD and HP- $\beta$ -CD with DAS, facilitating drug amorphization. Differential scanning calorimetry provided valuable insights into the thermal characteristics of the prepared complexes and the specific melting enthalpies of individual components. These specific melting enthalpies served as indicators of the reduced relative degree of crystallinity of the drug within the complexes. A comparable trend in thermograms of initial cyclodextrins and obtained samples indicated the possible inclusion of the drug within the cavity of the complexing agents with its amorphization. These findings were confirmed by Fourier-transformed infrared spectroscopy, revealing considerable changes in peak intensities of the drug in the obtained inclusion complexes spectra. *In vitro* release profiles in the presence of acetate buffer (pH = 4.0), containing 1% Triton X-100, showed an improvement in the solubility and release rate of DAS from inclusion complexes compared with the non-complexed drug.

Solvent-free co-grinding of hydrophobic drugs such as DAS with  $\beta$ -CD and HP- $\beta$ -CD is a promising approach for enhancing their dissolution rate, thereby significantly affecting their oral absorption and bioavailability.

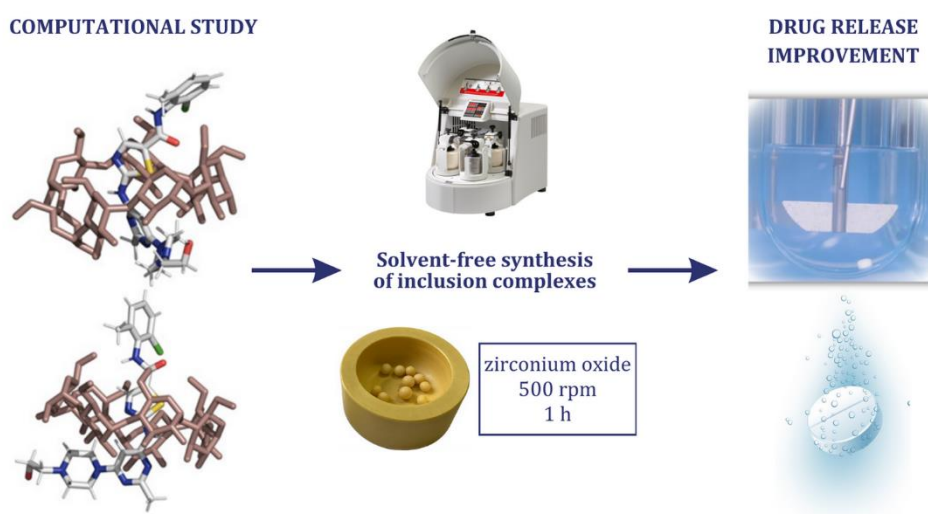

## KINETIC MODELLING *EX-SITU* BIOREMEDIATION OF LEACHATE

**Ivana Stojmilović<sup>1</sup>, Tomislav Domanovac<sup>2</sup>, Monika Šabić Runjavec<sup>1</sup>,  
Martina Trtinjak<sup>1</sup>, Marija Vuković Domanovac<sup>1</sup>**

<sup>1</sup>University of Zagreb Faculty of Chemical Engineering and Technology, Trg Marka Marulića 19, 10000 Zagreb, Croatia

<sup>2</sup>IPZ Uniprojekt TERRA, Voćarska cesta 68, 10000 Zagreb, Croatia  
istojmilov@fkit.unizg.hr

The continuous increase in the annual volume of waste poses a major challenge for sustainable resource management and environmental protection. One of the most important aspects of this problem is the significant amount of biowaste, which has the potential to create serious environmental and economic challenges. In addition to the quantity itself, the diversity of the components represents further challenge. The result of these two factors is heavily polluted leachate. Bioremediation is an attractive solution to these challenges from both a technical and environmental perspective. *Ex-situ* bioremediation is carried out under controlled conditions, which contributes significantly to the improvement of the biodegradation process.

In this work, *ex-situ* bioremediation of leachate from biowaste was carried out under batch conditions using the biostimulation technique. The bioremediation efficiency was  $88.7 \pm 0.5$  %. From a kinetic point of view, the Endo-Haldane model describes the bioremediation of biowaste leachate well, which is confirmed by the obtained F-test values of 0.95. The values of the biokinetic parameters  $\mu_{\max}$ ,  $K_S$ ,  $Y$ ,  $K_i$  and  $k_d$  were  $2.52 \pm 0.54$  1/d,  $38.44 \pm 8.39$  g/L,  $0.23 \pm 0.01$  g/g,  $119.02 \pm 8.99$  g/L and  $0.13 \pm 0.01$  1/g, respectively.

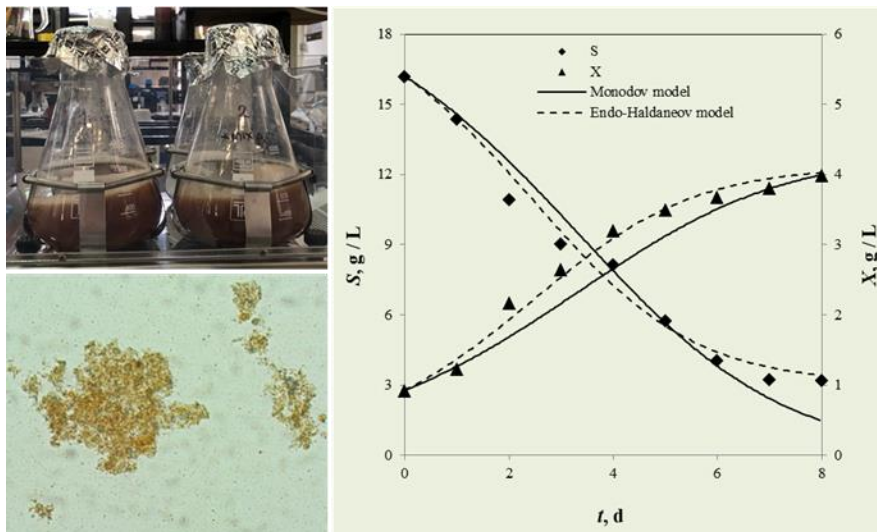

# KOMPOZITNE MIKROČESTICE NA TEMELJU KITOZANA I HIDROKSIAPATITA KAO NOSAČI LIJEKA

## CHITOSAN/HYDROXYAPATITE COMPOSITE MICROPARTICLES AS DRUG CARRIERS

**Lucija Vlahović, Andrea Lončarević, Anamarija Rogina**

University of Zagreb Faculty of Chemical Engineering and Technology, Trg Marka Marulića 19, 10000 Zagreb, Croatia  
lvlahovic@fkit.unizg.hr

Doxorubicin (DOX) is a fluorescent chemotherapeutic agent used in the treatment of various cancers, such as bone, breast and lung cancer. The main drawback of doxorubicin-based chemotherapy is its intravenous administration as an injectable solution at a high dosage while the whole organism is exposed to the drug's influence, eventually leading to cardiotoxicity [1,2]. To overcome these downsides, targeted drug delivery has been proposed. It is based on the formation of polymeric microcarriers and the incorporation of anticancer drugs at lower dosages compared to conventional chemotherapy. Chitosan (CHT) is a widely investigated polymer for this purpose due to its cationic character attributed to the presence of primary amino groups in its structure. Moreover, chitosan is a biocompatible and non-toxic natural polymer with properties such as *in situ* gelation, controlled drug release and mucoadhesion [3]. Stable chitosan-based microparticles can be formed through physical crosslinking of chitosan's functional (amino and hydroxyl) groups and cupric ions [4]. Furthermore, the addition of an inorganic phase (hydroxyapatite, HAp) to the polymer matrix can improve DOX loading due to the filler–drug interactions [5]. Thus, in this work, chitosan-copper(II)/hydroxyapatite (CHT-Cu/HAp) microparticles were prepared by electrohydrodynamic atomization. The chemical structure and composition of prepared dry microparticles were analyzed using attenuated total reflectance Fourier transform infrared spectroscopy (ATR-FTIR) and X-ray diffraction analysis (XRD). The influence of the addition of hydroxyapatite on the size, shape and swelling ability of microparticles was investigated using an inverted light microscope. The swelling property was determined in phosphate buffer solution at pH 6 and 7.4. The incorporation of the anticancer drug (DOX) into the prepared composite microparticles was examined using a fluorescence microscope. ATR-FTIR spectroscopy and XRD analysis indicated the presence of interactions between the polymer matrix and filler. All investigated systems (0-20 wt.% HAp) produced microparticles with high sphericity and variation in size depending on the HAp content. The smallest microparticles with the narrowest size distribution were obtained for the system with 5 wt.% HAp ( $53 \pm 8 \mu\text{m}$ ). The swelling degree increased at lower pH value of the incubation medium and at higher HAp content. Fluorescence microscopy confirmed successful incorporation of DOX into the prepared CHT-Cu/HAp microparticles.

33

- [1] P. Chagnenet-Barret, Phys. Chem. Chem. Phys. 15 (2013) 2937.  
 [2] S. Rivankar, J. Cancer Res. Ther. 10 (2014) 853-858.  
 [3] A. Bernkop-Schnürch et al., Eur. J. Pharm. Biopharm. 81 (2012) 463-469.  
 [4] A. Lončarević et al., Materials 14 (2021) 5630.  
 [5] C. Qiu et al., Mater. Today Bio 17 (2022) 100501.

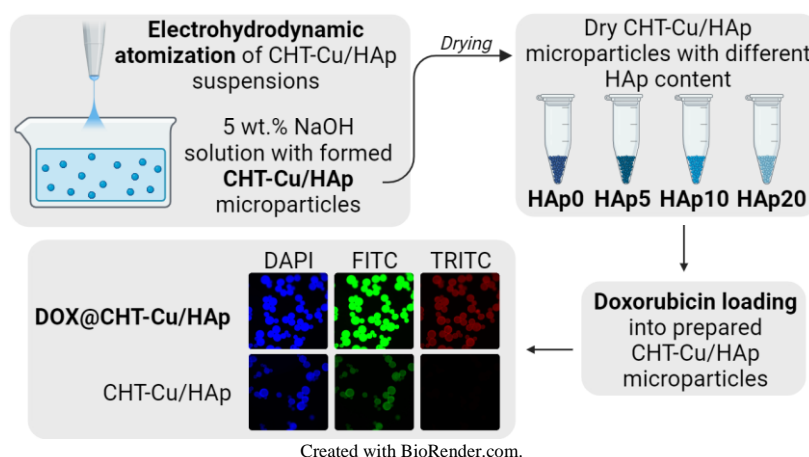

Created with BioRender.com.

## FABRICATION OF AN INKJET-PRINTED ELECTROCHEMICAL AZITHROMYCIN SENSOR USING INTENSE PULSED LIGHT

**Marko Zubak, Sara Krivačić, Željka Boček, Petar Kassal**

University of Zagreb Faculty of Chemical Engineering and Technology, Trg Marka Marulića 19, 10000 Zagreb, Croatia  
mzubak@fkit.unizg.hr

The widespread use of antibiotics leads to the development of resistant bacteria. To prevent the increase of bacterial resistance, it is necessary to take monitoring measures of the antibiotics concentration in the environment. In this case, it is necessary to create a low-cost sensor that can detect traces of antibiotics in water, soil or vegetables in situ [1]. In this research, a low-cost inkjet printed 3-electrode system for the detection of Azithromycin (AZI) was developed by using intense pulsed light (IPL). IPL is a useful technique from printed electronics, used for processing printed features on thermally sensitive substrates, with a pronounced effect on electrical properties and morphology. The presented sensing system was printed using graphene nanosheet ink (working and counter electrode) and silver nanoparticle ink (contacts and reference electrode, chlorinated with  $\text{FeCl}_3 \cdot 6\text{H}_2\text{O}$ ) on a polyimide sheet. The printing process was followed by photothermal treatment with IPL (2500 V; 539 J; 3 flashes). The optimal electrical properties of the sensor were obtained using the statistical software Design Expert, and as a response value, the sheet resistance was measured with a 4-point probe. The microscopic area of the working electrode ( $A = 8.76 \text{ mm}^2$ ) and heterogeneous electron transfer rate constant ( $k^0 = 0.0426 \text{ cm s}^{-1}$ ) were determined from cyclic voltammetry measurements of hexacyanoferrate(II)/(III) at different scan rates. The results are compared with a commercial screen printed electrode (SPE) and the microscopic area is comparable, while  $k^0$  is even higher than for SPE. Scanning electron microscopy was employed to determine the morphology of the sensor. The analytical properties of the sensor were tested using differential pulse voltammetry ( $R^2 = 0.989$ ). The fabricated sensor was validated with a testing solution of azithromycin in sodium hydrogencarbonate as electrolyte. The sensor exhibited high sensitivity and a low limit of detection. This inkjet printed 3-electrode system is reproducible with a relative standard deviation of 2.86% and suitable for mass production due to the versatile and scalable fabrication technique.

34

[1] Q. Wang et al., Chin. Chem. Lett. 32 (2021) 609-619.

This work was supported by the Croatian Science Foundation (projects UIP-2020-02-9139 and DOK-2021-02-2362).

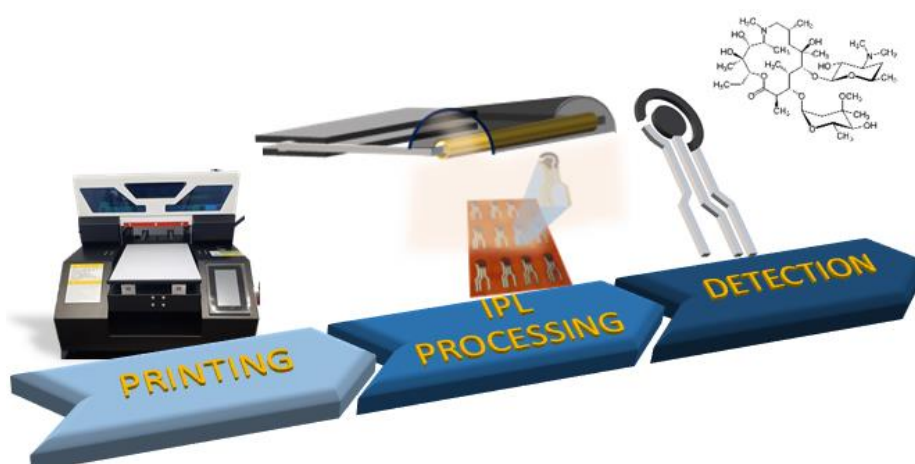

**POSTERSKA IZLAGANJA**  
***POSTER PRESENTATIONS***



**Biokemijsko inženjerstvo**  
*Biochemical engineering*

## APPLICATION OF THE MATHEMATICAL MODEL IN THE ANALYSIS OF THE EFFECT OF THE GLYCEMICAL LOAD OF A MIXED MEAL ON THE DYNAMICS OF GLUCOSE AND INSULIN

**Iva Beneti, Sara Maraš, Tea Sokač Cvetnić, Davor Valinger, Maja Benković, Tamara Jurina, Jasenka Gajdoš Kljusurić, Ana Jurinjak Tušek**

University of Zagreb Faculty of Food Technology and Biotechnology, Pierottijeva 6, 10000 Zagreb, Croatia  
ivabeneti@gmail.com

The glycemic load (GL) is a factor derived from the glycemic index, but in addition to the quality of the food, it also includes the amount of available carbohydrates in a serving of the food and therefore shows the blood glucose response much more realistically. Its values below 10 are considered a low glycemic load, between 11 and 19 a medium glycemic load, while the value above 19 presents a high load [1]. So, the higher the number of GL, the greater the influence of the food on the blood glucose concentration. Foods that contain more dietary fiber, less digestible or indigestible starch as well as proteins and fats have a lower GL because the carbohydrates are then less available, that is, glucose is released more slowly in the intestines, which causes a lower blood glucose response [2]. The purpose of this study was to investigate how the glycemic load of each mixed meal affects the concentration of glucose and insulin by using a mathematical model of glucose and insulin kinetics [3] in WR Mathematica. GL was determined for three different menus ((i) low-carb, (ii) diabetic and (iii) high-carb menus) that were developed for this purpose. The results showed that the high-glycemic load menu has a major effect on insulin and blood sugar levels. The percentage of carbs and proteins ( $r = -0.9500$ ) as well as the percentage of carbs and fats ( $r = -0.9855$ ) in the menus are negatively correlated. Based on all considered, the glycemic load of a single meal can be utilized as a starting point for modeling the metabolism of glucose and insulin. Use of the main nutrient metabolism model enables a customized approach to meal planning, a low-glycemic-load diet has been shown to be effective in stabilizing blood glucose concentration what would be beneficial for patients suffering from diabetes and for creating their daily meals and menus.

- [1] F. He et al., Nutr. Metab. 18 (2021) 31.  
[2] S. J. Bell and B. Sears, Crit. Rev. Food Sci. 43 (2023) 357-377.  
[3] C. C. Y. Noguchi et al., SICE J. Control Meas. Syst. Integr. 7 (2014) 314-320.

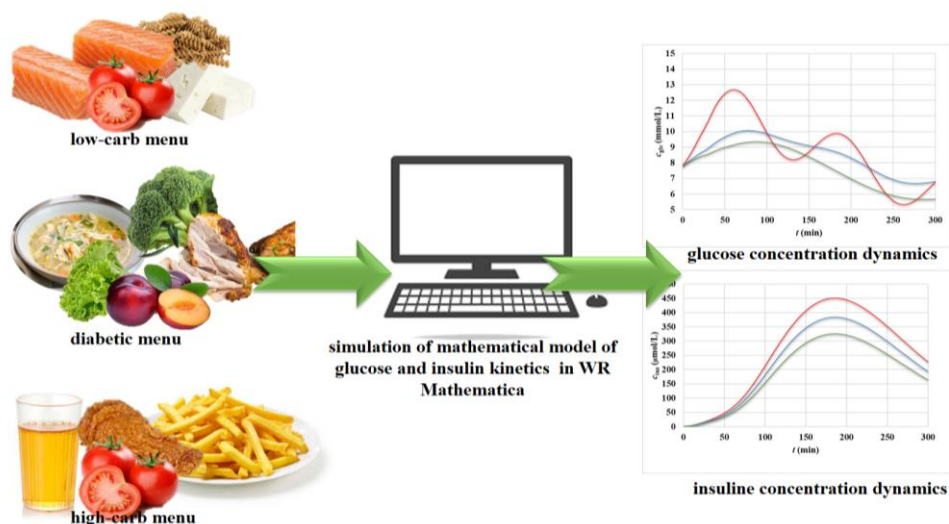

## ACTIVE EDIBLE FILMS AND COATINGS BASED ON SOY HULL PECTIN WITH THE ADDITION OF ESSENTIAL OILS

**Krsman Božović<sup>1</sup>, Marija Kostić<sup>2</sup>, Milica Perović<sup>1</sup>, Ljiljana Janjušević<sup>2</sup>, Mirjana Antov<sup>1</sup>**

<sup>1</sup>University of Novi Sad, Faculty of Technology, Boulevard cara Lazara 1, 21 000 Novi Sad, Serbia

<sup>2</sup> Institute BioSense, University of Novi Sad, Dr Zorana Đinđića 1, 21000 Novi Sad, Serbia  
bozovic.34.20.p@uns.ac.rs

Biodegradable films and coatings offer a compelling eco-friendly alternative to traditional plastics. Various biopolymers have been used to create materials for sustainable food packaging. Edible films can be applied onto or between food components while edible coatings form a protective layer on food products. Commonly used materials for these films and coatings include polysaccharides, proteins, and lipids, that could be extracted from different waste sources which makes them more sustainable. Essential oils, derived from plants and spices, offer great potential for usage in biodegradable food packaging. Their appeal lies in their natural origin and functional attributes, specifically antioxidant and antimicrobial properties. Biopolymer-based films enhanced with essential oils result in an active food packaging with potential to extend shelf-life of different food products.

In our research pectin was extracted from soybean husks by citric acid and further used for edible film and coatings preparation. To obtain active packaging different essential oils (cinnamon, oregano and lemon grass) were used. Produced films were tested regarding structural (SEM and ATR-FTIR analysis), antimicrobial and antioxidant properties. Results showed that films with essential oils exhibited high antimicrobial and antioxidant activity, likewise they were thicker compared to the control. Furthermore, coatings with the addition of essential oils demonstrated improved properties in terms of retention of freshness of cut fruits. Edible films and coating based on soy hull pectin with essential oils showed great potential to be used as active food packaging.

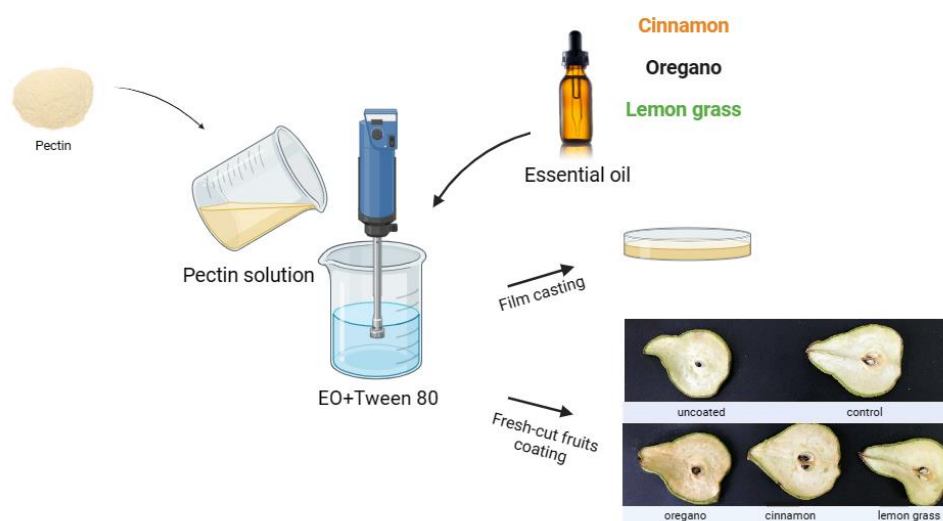

## PROIZVODNJA, PROČIŠĆAVANJE I KARAKTERIZACIJA ENDO-1,4- $\beta$ -KSILANAZE IZ *THERMOMYCES LANUGINOSUS*

### PRODUCTION, ISOLATION AND CHARACTERISATION OF ENDO-1,4- $\beta$ -XYLANASE FROM *THERMOMYCES LANUGINOSUS*

**Katarina Brkić, Anđela Matić, Marina Tišma**

Sveučilište Josipa Jurja Strossmayera u Osijeku, Prehrambeno-tehnološki fakultet Osijek, F. Kuhača 18, 31 000 Osijek, Hrvatska  
kbrkic@ptfos.hr

Zbog mogućnosti kataliziranja hidrolize ksilana (glavnog sastavnog dijela hemiceluloze) u ksilozu, endo-1,4- $\beta$ -ksilanaza može imati široku industrijsku primjenu [1]. Najčešće se koristi u prehrambenoj i papirnoj industriji te u proizvodnji biogoriva [2]. Cilj ovog rada bio je proizvesti, pročititi i karakterizirati endo-1,4- $\beta$ -ksilanazu iz *Thermomyces lanuginosus*. *T. lanuginosus* je uzgajana na pivskom tropu u uvjetima fermentacije na čvrstim nosačima tijekom 10 dana. Svakodnevno su mjerene volumne i specifične aktivnosti enzima. Najveća volumna aktivnost enzima postignuta je nakon 8 dana fermentacije (V.A.= 3159,06 U/mL). Proces pročišćavanja enzima proveden je na više načina: taloženjem u različitim koncentracijama amonijevog sulfata, smjesi amonijevog sulfata i *t* – butanola, jednostupanjskim i dvostupanjskim taloženjem u hladnom acetonu, te naknadno, u svrhu uklanjanja soli, dijalizom. S ciljem potvrđivanja molekulske mase enzima, provedena je elektroforeza i određena je molekulska masa enzima od 12,5 kDa. Dodatno, istraživana je utjecaj temperature i pH vrijednosti na aktivnost sirovog i djelomično pročišćenog enzima. Maksimalna aktivnost enzima (V.A.<sub>sirovi enzim</sub> = 4265,56 U/mL; V.A.<sub>pročišćeni enzim</sub> = 20859,44 U/mL) postignuta je pri temperaturi  $T = 85\text{ }^{\circ}\text{C}$  i pH 6.

- [1] N. Shahi et al., J. Chem. Pharm. Res. 8(3) (2016) 334-339.  
[2] Q. K. Beg et al., Appl. Microbiol. Biotechnol. 56 (2001) 326–338.



## INFLUENCE OF EDIBLE WHEY PROTEIN BASED COATING FORTIFIED BY OLIVE (*Olea Europea* L.) LEAF EXTRACT ON SOME PARAMETERS OF ENZYMATICALLY COAGULATED CHEESE

**Sara Cetin<sup>1</sup>, Elizabeta Zandona<sup>2</sup>, Katarina Lisak Jakopović<sup>1</sup>, Tomislava Vukušić Pavičić<sup>1</sup>, Irena Barukčić Jurina<sup>1</sup>**

<sup>1</sup>University of Zagreb Faculty of Food Technology and Biotechnology, Pierottijeva 6, 10000 Zagreb, Croatia

<sup>2</sup>Karlovac University of Applied Sciences, Trg J.J. Strossmayera 9, 47000 Karlovac, Croatia

sara.cetin99@gmail.com

Plant by-products are being extensively investigated for their reuse in food production due to their potential health benefits as well as in order to contribute to sustainable food production systems [1]. Olive leaf extract (OLE) has been proven to be a rich source of various phenolic compounds, with oleuropein being the most important one, demonstrating numerous health-protective properties [2]. Since dairy products are recognized as one of the most popular functional foods, but lack on polyphenolic compounds, the aim of this study was to investigate the effects of applying whey protein based edible coating with or without OLE addition of on some quality parameters of enzymatically coagulated cheese. The produced cheeses were ripened for 60 days, and samples were taken on days 1, 15, 30, 45, and 60. All samples were analysed for acidity (pH), antioxidant activity by the DPPH method, dry matter, ash, protein content and microbiological parameters. All of the analysed parameters were compared to control cheese without edible coating. According to the obtained results, cheeses with whey protein based edible coating regardless of OLE addition showed no significant difference to the control cheese in relation to the determined pH value, total dry matter and ash content. However, the application of an edible coating appeared to slow down the process of maturation, which was reflected in the higher total protein contents after 60 days of ripening in comparison to the control cheese. Thereby especially samples with OLE enriched coatings showed a considerably lower decrease in total protein content during the ripening period. Application of OLE enriched coatings also resulted in increased values of antioxidant activity of the cheeses and probably exhibited antimicrobial effects towards the end of ripening, resulting in better microbiological quality of the cheeses.

40

[1] M. Iriondo-DeHond et al., *Nutrients* 10 (10) (2018) 1358.

[2] P. Otero et al., *Res. Soc. Dev.* 10 (13) (2021) 1-17.

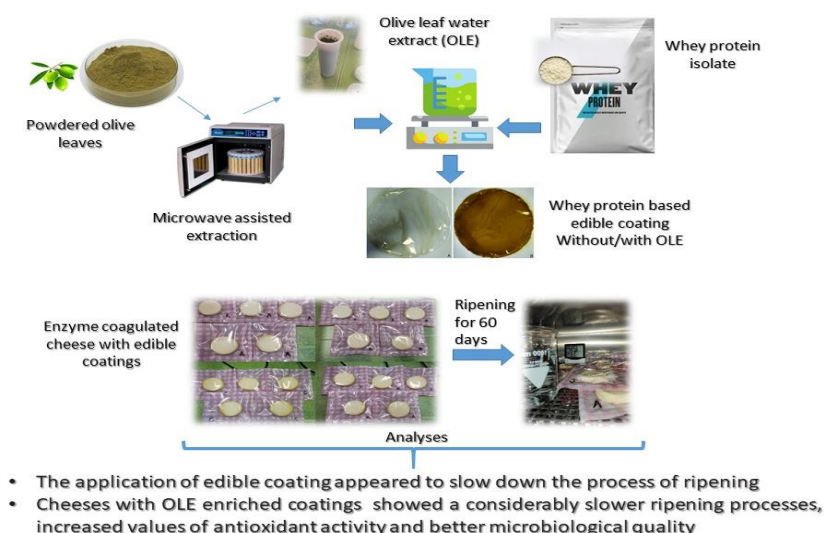

## DEEP EUTECTIC SOLVENTS – CREATING A GREEN SOLVENT FOR THE FUTURE THROUGH RATIONAL DESIGN

**Anja Damjanović, Mia Radović, Manuela Panić, Martina Bagović, Kristina Radošević, Marina Cvjetko Bubalo, Ivana Radojčić Redovniković**

University of Zagreb Faculty of Food Technology and Biotechnology, Pierottijeva ulica 6, 10000 Zagreb, Croatia  
adamjanovic@pbf.hr

One of the most important goals of green chemistry, as outlined in its 12 principles, is the reduction of conventional harmful solvents by replacing them with environmentally benign substitutes that reduce the energy requirements, have the least toxicity, and don't have major safety impacts. In search of more sophisticated approaches to solvent substitution, Deep Eutectic Solvents (DES) have emerged as an attractive alternative to common organic solvents, due to their cost-effectiveness, simple synthesis, and eco-friendly properties [1].

Their structure and physicochemical properties can be designed for specific purposes, so they have proven to be effective in various fields such as electrochemistry, organic synthesis and (bio)catalysis, biotechnology and food technology, pharmaceutical engineering and biomedicine, where they can fulfil the technological and economic demands of the industry [2]. However, the huge structural possibilities of DES often make the search for the so-called "ideal" DES (the one that outperforms conventional solvents or systems in a particular application) challenging and time-consuming. Therefore, to fully exploit the potential of DES and to speed up the process of designing DES with optimal properties it is essential to gain an in-depth understanding of the interactions of DES with biological systems at the molecular level. Also, *in silico* modeling of the relation between DES composition and their physicochemical properties or measurable outcome of their application (for example extraction yield, enzyme activity and selectivity and stabilization of target compound) provides exceptional assistance in finding the optimal DES for a specific process or product [3].

Here we present our long year experience on implementation of DES into various processes related to food technology, biotechnology and pharma: extraction of bioactives from plants, enzyme-catalyzed synthesis, stabilization of active pharmaceutical ingredients and proteins.

- [1] Y. Liu et al., J. Natural Prod. 81 (2018) 679-690.  
[2] M. A. R. Martins et al., J. Solution Chem. 48 (2019) 962-982.  
[3] M. Radović et al., Kem. Ind. 70 (2021) 551-562.

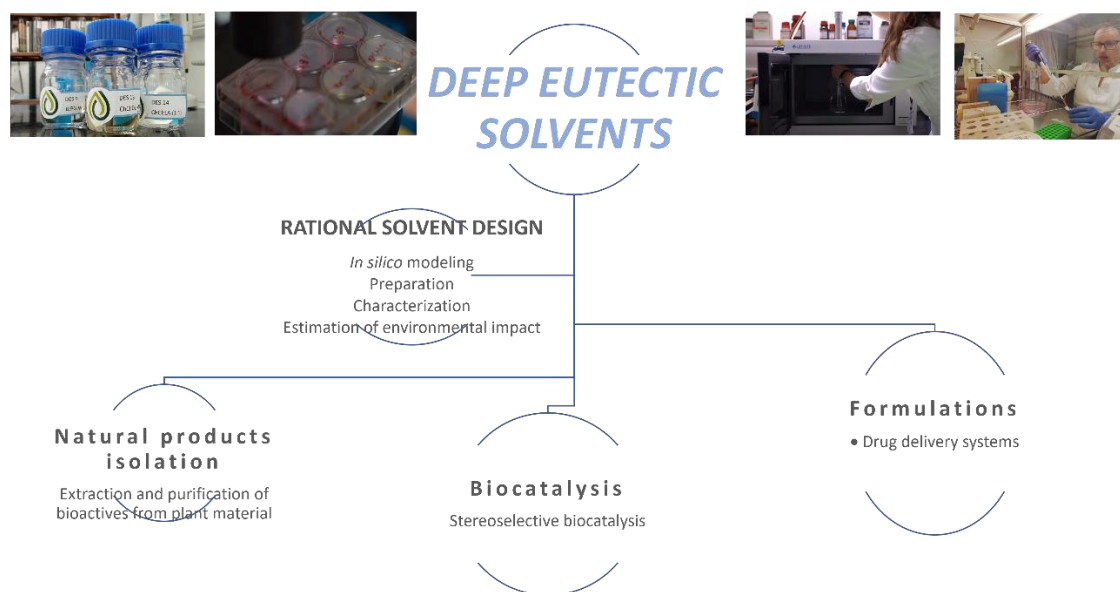

## EVALUATION OF PECTIN FROM SOY HULL AS AN INGREDIENT FOR EDIBLE FILMS AND COATINGS WITH LEMON GRASS ESSENTIAL OIL

**Dejan Dragaš<sup>1</sup>, Marija Kostić<sup>2</sup>, Milica Perović<sup>1</sup>, Ljiljana Janjušević<sup>2</sup>,  
Mirjana Antov<sup>1</sup>**

<sup>1</sup>University of Novi Sad, Faculty of Tehnology, Boulevard cara Lazara 1, 21 000 Novi Sad, Serbia

<sup>2</sup>Institute BioSense, University of Novi Sad, Dr Zorana Đinđića 1, 21000 Novi Sad, Serbia  
dragas.9.20.p@uns.ac.rs

Edible films and coatings are receiving more attention lately due to their advantages over synthetic packaging materials. The need for innovative, more environmental-friendly food packaging has encouraged the discovery of new materials. Different biopolymers can be used as a base for numerous natural active components with aim to be used for food preservation. Pectin, due to its biocompatibility, biodegradability and non-toxicity, has a great potential for edible films and coatings production [1]. Pectin is widely used in the food industry as a stabilizing, thickening and gelling agent; hence, there is increased interest in alternative sources and procedures of its isolation, especially from waste materials. For the preparation of packaging films and coatings, pectin extracted from soy hull was used. Pectin was extracted by two green protocols using citric acid instead of HCl – the one at elevated temperature and the other by ultrasound. Additionally, pectin was extracted using the conventional method with 0.05 M HCl. Packaging films prepared from pectins with the addition of lemon grass essential oil were characterized regarding their thickness, antimicrobial and antioxidant activity. Structural properties of films and coatings included cross-section imaging via SEM and ATR-FTIR analysis. All edible pectin coatings with the addition of essential oil demonstrated increased thickness compared to those composed without oil. Obtained formulations were also used for fresh-cut coating and results showed that coatings with the addition of essential oil have better characteristics in terms of preserving the freshness of the fruits.

[1] T. Nisar et al., Int. J. Biol. Macromol.106 (2018) 670-680.

42

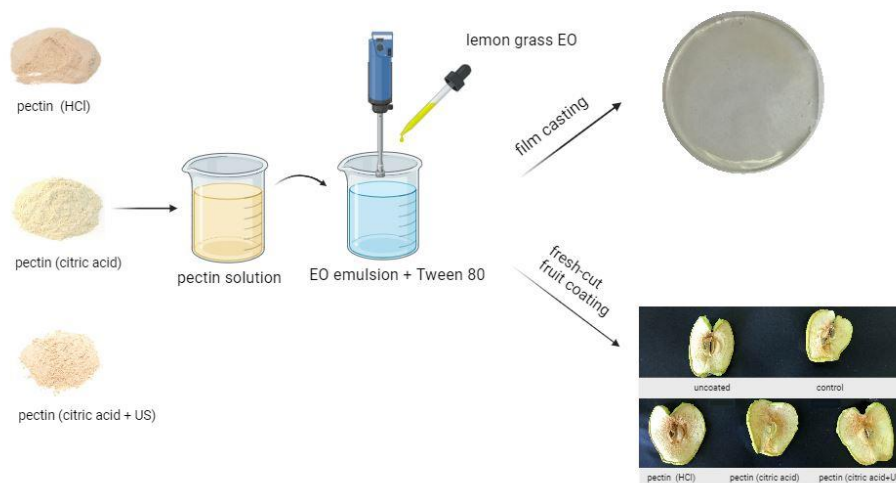

## SELECTIVE ANTIRADICAL ACTIVITY OF BLACK GOJI LIPOSOMAL EXTRACTS: IMPLICATIONS FOR OXIDATIVE STRESS THERAPY

**Marko Jovanović<sup>1</sup>, Đura Nakarada<sup>2</sup>, Stevan Blagojević<sup>1</sup>, Hadi Waisi<sup>1</sup>, Miloš Mojović<sup>2</sup>**

<sup>1</sup> Institute of General and Physical Chemistry, Studentski trg 12/V, 11158 Belgrade, Serbia

<sup>2</sup> University of Belgrade, Faculty of Physical Chemistry, Studentski trg 12-16, 11000 Belgrade, Serbia  
mjovanovic@iofh.bg.ac.rs

The black Goji berry (*Lycium ruthenicum*) thrives in the deserts of the Tibet plateau and is extensively utilized in traditional medicine to address various health concerns. Scientific evidence indicates that extracts from this fruit possess a broad spectrum of anti-inflammatory and antitumor properties. Despite this, there is a lack of comprehensive studies on its antiradical activity. The goal of this study was to encapsulate/incorporate black Goji berry extracts into DPPC model liposomes in order to enhance their bioavailability and potential pharmacokinetic effects, and to evaluate their antiradical activity towards DPPH and hydroxyl radical species using electron paramagnetic resonance (EPR) spectroscopy.

Ripe berry extracts were prepared using various solvents (water at pH 1.5, 4.5, and 7.0, 75% EtOH, 80% MeOH, and 80% MeOH at pH 2.0) in a 1:10 w/v ratio [1]. Following the extraction, all extracts underwent screening for antiradical activity against DPPH radicals. The results revealed that 80% MeOH extracts of black Goji berries exhibited the highest antiradical activity (70.71%), followed by 75% EtOH extracts (46.87%), and water extracts (12.61-18.91%). However, due to health concerns, MeOH extracts are unsuitable for pharmacological applications. To address this, dipalmitoylphosphatidylcholine (DPPC) liposomes (200 nm) were prepared, containing active components obtained after vacuum volatilization of 80% MeOH Goji berry extracts, using thin film and extrusion methods [2]. Their size and stability were confirmed using the dynamic light scattering method. These liposomes were tested to assess whether the encapsulation process affected their scavenging ability against DPPH<sup>•</sup> and <sup>•</sup>OH radicals. The obtained results indicate that liposomes containing active components of 80% MeOH Goji berry extracts successfully eliminated 43.59% of DPPH and 75.55% of hydroxyl radicals from the system. Importantly, this outcome was in accordance with the results obtained for plain MeOH extracts diluted to correspond to the concentration of extract (50.95% for DPPH radicals).

These findings imply that even with the integration of extracts into liposomes, noteworthy antiradical activity retains or even increases (if more concentrated extracts are used). Our results indicate that 80% MeOH extracts of black Goji berries possess strong but selective antiradical activity, making them a promising remedy for the treatment of various health conditions related to oxidative stress.

[1] Đ. Nakarada et al., *Hosp. Pharm. Int. Multidiscip. J.* 8 (2021) 1004-1013.

[2] Đ. Nakarada et al., *J. Liposome Res.* 30 (2020) 218-226.

The financial support for this research was provided by the Ministry of Science, Technological Development and Innovation of the Republic of Serbia, contract number 451-03-47/2023-01/200146. The authors express gratitude to Zorkić Organic Farm in Belgrade, Serbia, for generously supplying the black Goji berry samples.

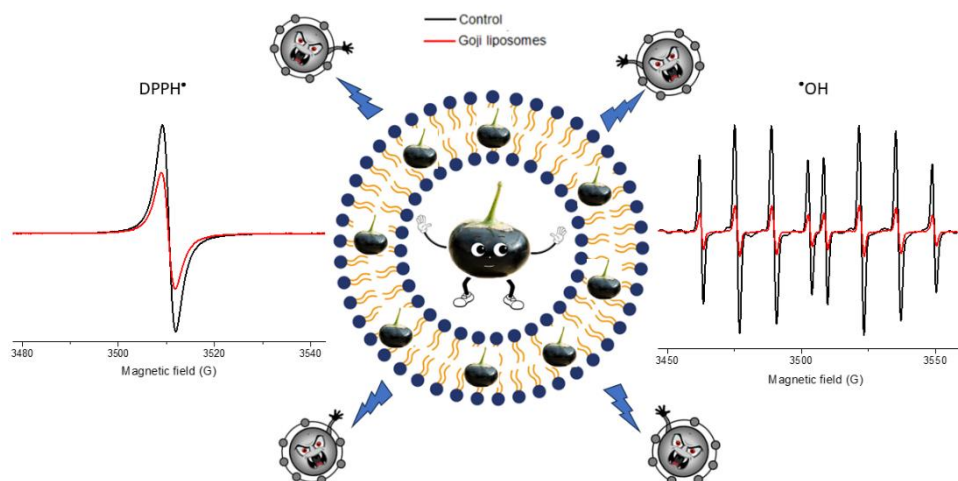



# KINETIČKA KARAKTERIZACIJA KETOREDUKTAZE U REAKCIJI OKSIDACIJE OPTIČKI AKTIVNOG ALKOHOLA

## KINETIC CHARACTERIZATION OF KETOREDUCTASE IN THE OXIDATION OF OPTICALLY ACTIVE ALCOHOL

**Lea Karamatić, Emerik Leaković, Ana Vrsalović Presečki**

Sveučilište u Zagrebu Fakultet kemijskog inženjerstva i tehnologije, Trg Marka Marulića 19, 10000 Zagreb, Hrvatska  
lkaramati@fkit.unizg.hr

Industrijska biotehnologija, koja se temelji na biokatalizi, uključuje upotrebu stanica ili njezinih dijelova (enzima) za sintezu industrijski korisnih produkata u kemijskom i prehrambenom sektoru i proizvodnji biogoriva. Biokataliza je zelena i održiva tehnologija. Tijekom posljednjih desetljeća upotreba enzima dobivenih iz prirodnih izvora ili generiranim metodama značajno se povećala. Enzimska sposobnost kataliziranja novih reakcija, prepoznata je kao vrijedan alat za istraživanje i sintezu. Proteinski inženjering omogućio je optimizaciju postojećih enzima i mogućnosti provedbe posve novih biokatalitičkih reakcija koje su prije bile nepoznate u prirodi [1]. Matematički modeli, posebice korišteni u kombinaciji s računalnim tehnikama, su vrlo učinkovit alat u traženju optimalnih radnih uvjeta u dizajnu, radu i kontroli enzimskih reaktora [2].

U ovome radu ispitala se kinetika enzima ketoreduktaze u reakciji oksidacije optički aktivnog alkohola. (Slika 1.) Također se ispitala i kinetika povratne reakcije, redukcije ketona, i kinetika reakcije regeneracije koenzima  $\text{NAD}^+$  uz enzim NADH oksidazu. Sve tri reakcije su opisane dvosupstratnom Michaelis-Menteničinom kinetičkim modelom uz uključene dokazane inhibicije pojedinih komponenata reakcijske smjese. Na temelju određenog kinetičkog modela, postavljen je matematički model u kotlastom reaktoru. Simulacijama pomoću modela se ispitaio utjecaj početnih varijabli na vrijeme trajanja procesa.

- [1] R.A. Sheldon et al., Chem. Rev. 118 (2017) 801-838.  
[2] A. Illanes, Enzyme Biocatalysis, Springer, 2008, 1-19.

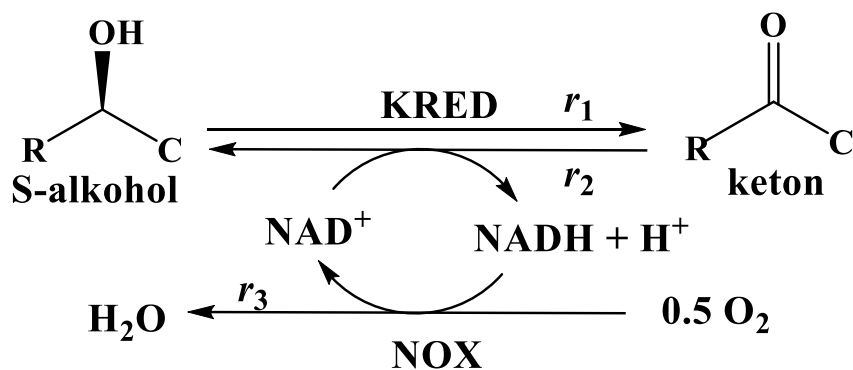

Slika 1. Shema reakcije

## HEAT-INDUCED NANOPARTICLES FROM PUMPKIN LEAVES PROTEIN FRACTIONS AS NANOCARRIERS FOR ANTHOCYANINS

**Predrag Karas, Milica Perović, Mirjana Antov**

University of Novi Sad, Faculty of Technology Novi Sad, Bul. cara Lazara 1, 21000 Novi Sad, Serbia  
predragkaras33@gmail.com

The application of nanotechnology in food systems has potential to provide new methods for the improvement of food safety and packaging, nutritional value as well as delivery of bioactive compounds to target sites [1]. Protein-based nanoparticles are known as non-toxic, biodegradable, easily metabolized and with good biocompatibility, compared to others [2]. Pumpkin leaves represent waste material in pumpkin production and could be potential source of crude proteins with high nutritional value. Proteins from pumpkin leaves can be divided into two fractions - green fraction, which represents chlorophyll related proteins, and white fraction that is mainly RuBisCO protein.

The aim of the present work was to produce nanoparticles from pumpkin leaf proteins by heat treatment and to evaluate their properties. Proteins were isolated by thermal coagulation (green fraction) and isoelectric precipitation (white fraction) from green juice of pumpkin leaves. Nanoparticles formation was induced by heat treatment at 90 °C, and at pH 6 or 9. Results showed that size of nanoparticles was different in dependence of protein fraction, concentration and applied pH, and varied from 168 to 270 nm. Furthermore, nanoparticles from both green and white fractions showed ability of binding the anthocyanins from aronia juice. Nanoparticles prepared from white fraction had higher binding capacity of anthocyanins (30%) compared to those from green fraction (13%). Both protein fractions from pumpkin leaves could be a great protein source for the preparation of nanoparticles with advanced properties for the application in food sector.

- [1] A. E. Ghaly et al., Am. J. Appl. Sci. 7 (3) (2010) 331.  
[2] M. L. Verma et al., Int. J. Biol. Macromol. 154 (2020) 390-412.

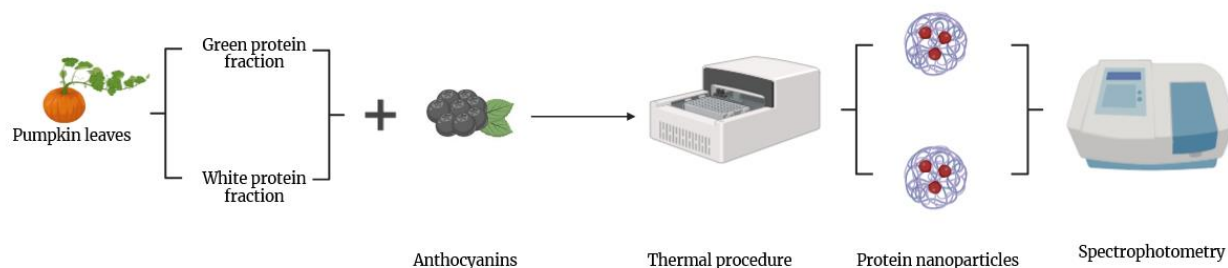

# OPTIMIZATION OF SEPARATION PROCESSES AND IMMOBILIZATION OF LACCASE OBTAINED FROM *PLEUROTUS OSTREATUS* AND *GANODERMA LUCIDUM*

**Pia Keršič<sup>1</sup>, Katja Vasić<sup>1</sup>, Mateja Primožič<sup>1</sup>, Željko Knez<sup>1,2</sup>, Maja Leitgeb<sup>1,2</sup>**

<sup>1</sup>University of Maribor, Faculty of Chemistry and Chemical Engineering, Laboratory of Separation Processes and Product Design, Smetanova ulica 17, 2000 Maribor, Slovenia

<sup>2</sup>University of Maribor, Faculty of Medicine, Taborska ulica 8, 2000 Maribor, Slovenia  
pia.kersic1@um.si

Many studies and researches have proven the medicinal and nutritional value of *Pleurotus ostreatus* as well as the medicinal value of *Ganoderma lucidum*, with *P. ostreatus* being one of the most cultivated edible mushrooms worldwide [1], *G. lucidum* already being used for medicinal purposes in Asia, especially in China, for centuries [2]. Along with having anti-inflammatory, antioxidative, antihyperglycemic and antimicrobial properties as well as having high nutritional value, they possess a variety of enzymes [1] [2]; our target enzymes were laccase,  $\alpha$ -amylase and cellulase. The aim was to optimize the separation of laccase from  $\alpha$ -amylase and cellulase in mushroom water extracts, as well as the optimization of quantification of all three aforementioned enzymes. As enzyme activity and stability is dependent on many different factors, including temperature and pH levels, one must take these into account. To add to it, cellulase is an amalgamation of different subunits and molecular structures, which in turn means a wide range of different molecular weights, optimization was a much-needed procedure.

Two strains of fungi, namely *G. lucidum* and *P. ostreatus* were cultivated using solid state fermentation on medium-sized wheat bran (0.8 mm), both strains cultivated in duplicates. After 8 days of growth, water extracts were obtained and properly stored. Optimization of gel chromatography was performed, enzymatic kinetics for all three enzymes were investigated, water extract samples from our cultivated mushrooms were prepared with the optimized procedures, total protein concentration was determined and compared between the two different fungi. Antimicrobial properties were evaluated briefly. After successfully separating the enzyme laccase from water extracts, the immobilization of laccase on two types of magnetic particles, comparing the activity, stability, and other physio-chemical properties between free and immobilized laccase were proceeded.

The optimized separation process in our case was a column filled with Sephadex G-100 gel (1.8 x 30 cm), the mobile phase being 50 mM sodium acetate buffer at pH=5.0. Our research showed that all three enzymes were present at a significant amount in both strains of fungi, with laccase activity being only slightly higher in *G. lucidum*, with  $1.38 \pm 0.19$  U/mL, compared to  $1.01 \pm 0.11$  U/mL in *P. ostreatus*. Activity of  $\alpha$ -amylase was the highest out of all three enzymes, *G. lucidum* having  $18.73 \pm 0.34$  U/mL and *P. ostreatus*  $17.47 \pm 0.33$  U/mL of activity. Cellulase activity was high, with  $8.66 \pm 0.22$  U/mL in *G. lucidum* extract and  $8.14 \pm 0.21$  U/mL in *P. ostreatus* extract. Even though the activity of laccase was the lowest out of the three target enzymes, it was the only enzyme we could wholly separate from the water extract,  $\alpha$ -amylase and cellulase being present simultaneously in most of the fractions; laccase is also one of the more expensive enzymes and very useful in many applications, ranging from water remediation and dye degradation to healthcare and usage in food industry. [2]

[1] A. Gregori et al., Food Technol. Biotechnol. 45 (2007) 238–249.

[2] E. Ekiz et al., Foods 12 (2023) 1512.

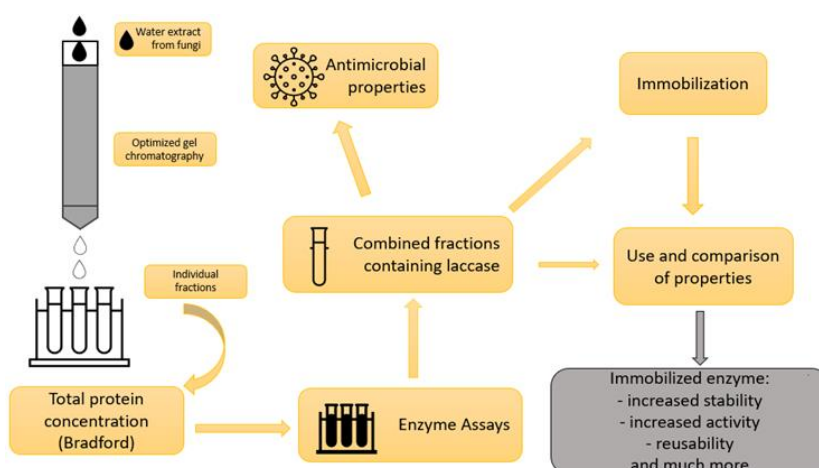

# KINETIČKA KARAKTERIZACIJA IMOBILIZIRANOG ENZIMA DERA

## KINETIC CHARACTERIZATION OF IMMOBILIZED DERA ENZYME

**Karla Krešić, Barbara Arambašić, Petra Plavčić, Dino Skendrović,**  
**Ana Vrsalović Presečki**

Sveučilište u Zagrebu Fakultet kemijskog inženjerstva i tehnologije, Trg Marka Marulića 19, 10000 Zagreb, Hrvatska  
 kkresic@fkit.unizg.hr, arambasic.barbara@gmail.com, pplavcic@fkit.unizg.hr

Sintezu laktola katalizira enzim 2-deoksiriboza-5-fosfat aldolaza (DERA). Enzim DERA pripada skupini aldolaza te se koristi u proizvodnji kiralnih laktola. Laktoli su prekursori za proizvodnju bočnog lanca statina, koji se koriste kao lijekovi za snižavanje razine kolesterola u krvi. Kako se sinteza statina katalizirana kemijskim putem provodi pri vrlo nepovoljnim uvjetima, korištenje enzima DERA za sintezu bočnih lanaca statina omogućava poboljšanje procesa na način da se oba stereocentra uvode u jednom koraku. Reakcija se provodi tako da akceptorski supstrat kloroacetaldehid u prvom koraku reagira s donorskim supstratom acetaldehidom dajući produkt 4-kloro-3-hidroksi butanal, koji naknadno reagira s acetaldehidom dajući ključni produkt 6-kloro-3,5-dihidroksi heksanal (Slika 1). Problem ove reakcije je što visokim koncentracijama aldehida dolazi do inaktivacije enzima što utječe na smanjenje aktivnosti i količine željenih proizvoda. Jedan od načina za rješavanje tog problema je imobilizacija enzima. Imobilizacija je proces kojim se enzim kovalentno ili fizički veže na površinu nosioca, ili se uklapa u njegovu strukturu, te time enzimi postaju manje osjetljivi na reakcijske inhibitore te su zaštićeni od nepovoljnih reakcijskih uvjeta. Mezoporozna silika kao nosioc ima veliku specifičnu površinu, kemijsku, mehaničku i termalnu stabilnost te ujednačenu raspodjelu veličina pora što je čini idealnim kandidatom nosioca za imobilizaciju.

U ovom radu provedena je imobilizacija enzima DERA na mezoporoznu siliku u svrhu povećanja njegove stabilnosti. Za određivanje kinetike enzima korištena je metoda početnih brzina. Kinetika je određena u oba stupnja reakcije i opisana je pomoću dvosupstrate Mihaelis-Mentenčine jednadžbe, te je praćena kod slobodnog i imobiliziranog enzima radi njihove usporedbe. Nakon određivanja kinetičkih parametara nelinearnom regresijom pomoću MicroMath SCIENTIST software-a, uslijedila je validacija modela u kotlastom reaktoru.

47

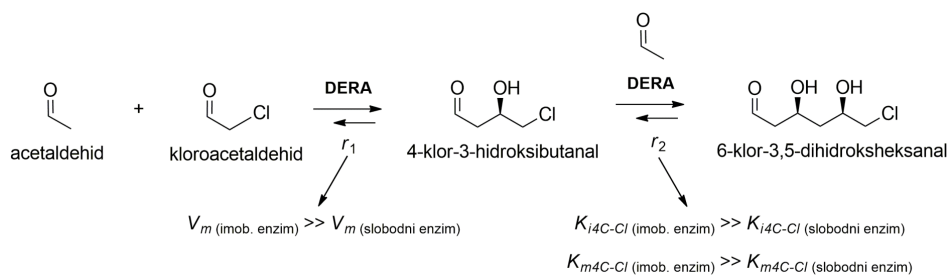

Slika 1. Prikaz sinteze prekursora statina 6-klor-3,5-dihidroksiheksanala te kinetičkih poboljšanja dobivenih imobilizacijom enzima

## GRAPE SKIN COMPOST QUALITY AND MATURITY ASSESSMENT

**Korina Krog, Tea Sokač Cvetnić, Davor Valinger, Maja Benković, Tamara Jurina, Jasenka Gajdoš Kljusurić, Ivana Radojčić Redovniković, Ana Jurinjak Tušek**

University of Zagreb Faculty of Food Technology and Biotechnology, Pierottijeva 6, 10000 Zagreb, Croatia  
krogkorina@gmail.com

During wine production, grape pomace is produced in amounts of 20–25% of the total mass of the pressed grapes, and it is composed of grape skins, seeds, and stalks [1]. This waste is often disposed in the landfills, where the decomposition of organic waste takes place and leads to the production of odor and leachate, which pose a risk to the environment and human health. Composting has been considered to be the most effective and environmentally friendly process, in which organic waste is recycled and transformed into a “compost”, presenting a product rich in nutrient content with a low prevalence of pathogenic microorganisms. In this study, nine composting processes of grape skin were performed in laboratory reactors under different conditions of moisture content of the initial substrate (50–65%) with an air flow rate (0.350–1.700 L/min) for 30 days. Compost maturity was analyzed every five days based on a germination test with 20 salad seeds. Compost quality, at the end of the composting process, was devalued based on the bulk density and porosity of the compost samples. Results showed changes in germination index during the composting process due to the presence of different compounds in different stages of organic matter degradation. After 30 days of composting, germination indexes were in the range of 74.211–22.426%, indicating the compost sample's maturity and is also free of toxic substances or less toxic to germination [2]. Furthermore, after 30 days of composting, the bulk density value ranged from 323.803 to 428.805 kg/m<sup>3</sup> and the porosity values ranged from 61.257 to 73.563%, for different compost samples. According to the results, the porosity of the compost samples decreased with increasing bulk density.

- [1] M. Spinei and M. Oroian, *Foods* 10 (2021) 867.  
[2] M.S. Islam et al., *Sustainability* 13 (2021) 8458.

The work was supported by the European Union through the European regional development fund, Competitiveness and Cohesion 2014–2020 (KK.01.1.1.07.0007.)



# FORMULATION OF LIPOSOMES WITH ENCAPSULATED *HELICHRYSUM ITALICUM* FOR THE COSMETICS INDUSTRY

**Nika Kučuk<sup>1</sup>, Mateja Primožič<sup>1</sup>, Željko Knez<sup>1,2</sup>, Maja Leitgeb<sup>1,2,\*</sup>**

<sup>1</sup> University of Maribor, Faculty of Chemistry and Chemical Engineering, Laboratory of Separation Processes and Product Design, Smetanova ulica 17, 2000 Maribor, Slovenia

<sup>2</sup> University of Maribor, Faculty of Medicine, Taborska ulica 8, 2000 Maribor, Slovenia  
nika.kucuk@um.si

Liposomes are receiving increasing attention as one of the most promising delivery systems for various therapeutic agents due to their exceptional properties such as biocompatibility, biodegradability, non-toxicity, non-immunogenicity, non-pathogenicity, and great versatility. They are self-assembled spherical nano-scale vesicles comprising one or more concentric phospholipid bilayers surrounding a hydrophilic core [1]. Hydrophilic compounds can be incorporated into the hydrophilic interior of the liposome vesicle, while hydrophobic molecules can be incorporated between hydrophobic tails. Because of these unique properties, liposomes can be used to manufacture quality cosmetics formulations [2]. Liposomes with encapsulated bioactive ingredients included in cosmetic formulations allow better penetration of bioactive compounds into the skin, thereby increasing the effectiveness of the cosmetic skincare product. Liposomes can be synthesized from various naturally occurring substances. The main components of the liposomal lipid bilayer are phospholipids such as phosphatidylcholine and sterols, especially cholesterol, which are generally recognized as safe (GRAS). It is important to emphasize that natural lipids are compatible with human tissue. Therefore, they are not perceived as foreign by the body [3].

The study aimed to synthesize liposomes suitable for the potential encapsulation of bioactive substances from *Helichrysum italicum* distillate for possible use in cosmetic formulations. The liposomes were synthesized from phosphatidylcholine and cholesterol using a thin lipid film hydration method with glass beads. The synthesized liposomes were characterized by measuring the zeta potential to determine their stability, polydispersity index, and particle size using the Zeta Sizer Nano ZS instrument. In addition, the bioactive substances from *H. italicum* distillate were incorporated into the liposomes. The encapsulation efficiency and the amount of *H. italicum* distillate incorporated into the liposomes as well as the kinetics of *in vitro* release of the loaded *H. italicum* distillate were investigated using the dialysis technique.

Synthesized nano-scale liposomes were stable, with an average size of 197 nm. The highest encapsulation efficiency (56%) and the highest percentage of released bioactive ingredients (64%) were obtained at 200 mg/mL of *H. italicum* distillate. Liposomes loaded with *H. italicum* distillate represent promising modern delivery systems stabilizing natural ingredients that can be used in various biomedical applications and the cosmetics industry for the production of different lotions and creams.

- [1] M. Li et al., Eur. J. Med. Chem. 164 (2019) 640–653.  
[2] M. Leitgeb et al., J. Supercrit. Fluids 165 (2020) 104984.  
[3] A. Wang et al., AAPS Pharm. Sci. Tech. 18 (2017) 3227–3235.

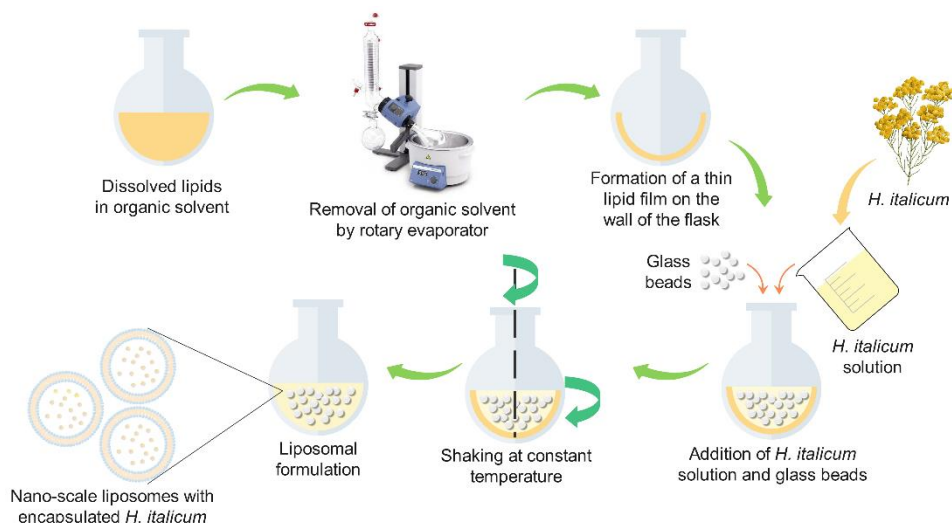

## DEVELOPEMENT OF ANTIBACTERIAL NANOCELLULOSE FILMS WITH BIOACTIVE COMPOUNDS FROM *Persea americana* SEEDS

**Kaja Kupnik<sup>1,2</sup>, Mateja Primožič<sup>1</sup>, Vanja Kokol<sup>2</sup>, Željko Knez<sup>1,3</sup>, Maja Leitgeb<sup>1,3</sup>**

<sup>1</sup>University of Maribor, Faculty of Chemistry and Chemical Engineering, Laboratory for Separation Processes and Product Design, Smetanova ulica 17, 2000 Maribor, Slovenia

<sup>2</sup>University of Maribor, Faculty of Mechanical Engineering, Smetanova ulica 17, 2000 Maribor, Slovenia

<sup>3</sup>University of Maribor, Faculty of Medicine, Taborska ulica 8, 2000 Maribor, Slovenia  
kaja.kupnik@um.si

Management of skin infections is a burden of healthcare system worldwide and requires additional scientific efforts. Incorporation of antimicrobial agents into therapeutic wound dressings is necessary, which in turn enables prevention and/or treatment of infections.

Cellulose, as the most abundant biopolymer, has shown potential for divergent applications in wide range area of life science, especially in its functionalized forms. Availability, biodegradability, nontoxicity, light weight, and high aspect ratio made cellulose nanofiber (CNF) a high applicable organic nanofiller in nanocomposites with good barrier and mechanical properties.

On the other hand, the increase of multidrug resistant bacteria stimulated the search for natural antimicrobial agents. Avocado (*Persea americana*) seeds are a rich source of bioactive compounds with high antimicrobial activity [1], what makes them attractive for the development of active biomaterials.

The objective of our study was to develop antimicrobial bio-nanocomposites containing CNF and bioactive compounds from avocado seeds, which were recovered using ethanol as a solvent. Bio-nanocomposite films were prepared using a casting method. Prepared dispersions of CNF and avocado seed extract were casted onto Petri dishes and dried under controlled conditions. The developed films were subjected to antibacterial efficiency tests against Gram-negative bacteria *Escherichia coli*.

The results of the research showed successful development of antibacterial active bio-nanocomposite films with CNF and compounds from avocado seeds, potential for applications in biomedicine, cosmetic, and pharmaceutical industries.

50

[1] Kupnik et al., Plants 12 (2023) 1201.

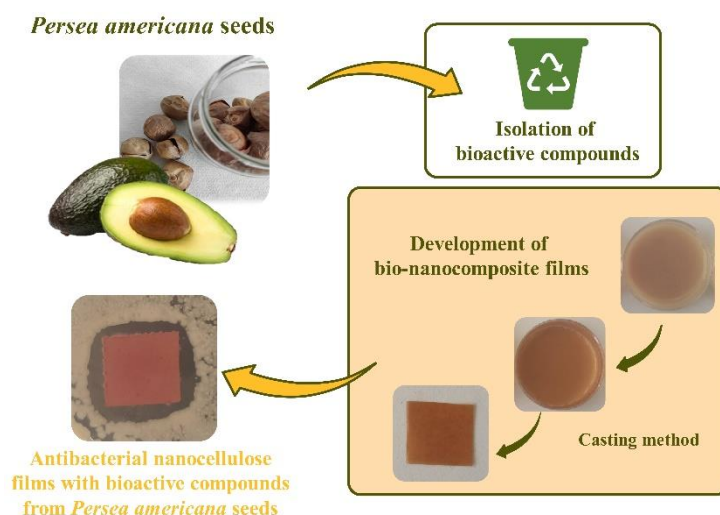

## COMPARATIVE STUDY OF ARABINOXYLANS EXTRACTED FROM WHEAT CHAFF WITH SPECIAL REFERENCE TO THEIR VISCOSITY

**Nina Kustudić, Tatjana Đorđević, Mihajlo Valuh, Mirjana Antov**

University of Novi Sad, Faculty of Technology, Boulevard Cara Lazara 1, 21000 Novi Sad, Serbia  
nina.kustudic@gmail.com

As sustainability is becoming a more relevant issue globally, there has been a search for innovative approaches to repurposing industrial by-products, especially agro-industrial waste such as wheat chaff. Wheat chaff is a valuable source of polysaccharides, particularly arabinoxylan (AX), which is the major non-starch component of plant cell wall. AX constitutes a part of the dietary fiber portion of cereals, contributing to their functional attributes and nutritional value [1]. Arabinoxylans could form gels through the oxidative coupling of ferulic acid in their structure. Ferulated AXs exhibit notable characteristics, such as high-water absorption capacity, stability to pH, temperature, and ionic changes, as well as various biological properties including antioxidant, prebiotic and anticancer activities; when cross-linked in gels they could represent excellent alternatives as targeted drug delivery systems [2].

Wheat chaff was subjected to various extraction procedures, including enzymatic, alkaline, hydrothermal, and enzyme-assisted hydrothermal ones. Extracted arabinoxylans were characterised and their properties were compared with particular attention to their viscosity. The structure of extracted arabinoxylans was analysed by FTIR spectroscopy in a range of 4000–400  $\text{cm}^{-1}$ . The yields of AXs differed - the alkaline extraction was the most effective (73 mg/g) and the enzymatic had the lowest value (1.65 mg/g). The enzyme-assisted hydrothermal extraction was slightly more efficient than the hydrothermal one with arabinoxylan yield 10.22 mg/g and 9.65 mg/g, respectively. The AX extracted by different procedures exhibited different composition and rheological properties which could be a solid basis for the formation of arabinoxylan gels with laccase.

- [1] S. Yilmaz-Turan et al., Food Hydrocoll. 2022, 128, 107575.  
[2] M. Mendez-Encinas et al., Oxid. Med. Cell. Longev. 2018 (2018) 2314759.

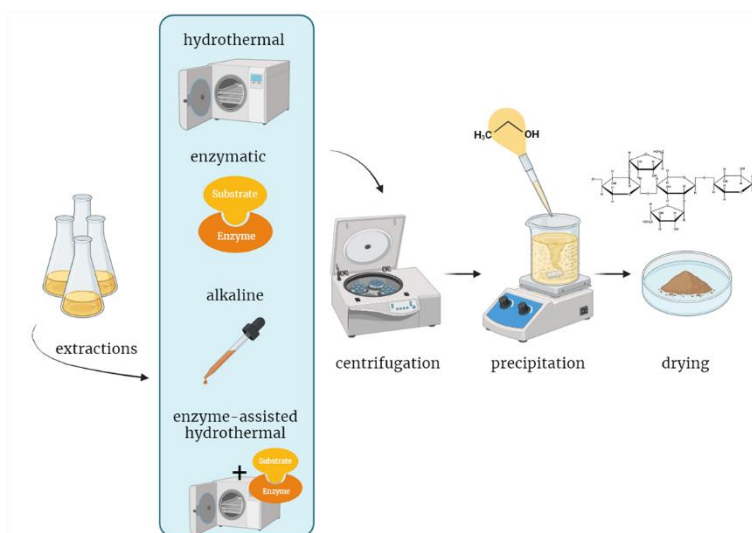



## RHODODENDROL PRODUCTION – MODEL VALIDATION

**Emerik Leaković<sup>1</sup>, Karsten Siems<sup>2</sup>, Michel Feussi Tala<sup>2</sup>, Antonia Habazin<sup>1</sup>,  
Zvezdana Findrik Blažević<sup>1</sup>, Ana Vrsalović Presečki<sup>1</sup>**

<sup>1</sup> University of Zagreb Faculty of Chemical Engineering and Technology, Trg Marka Marulića 19, 10000 Zagreb, Croatia

<sup>2</sup> AnalytiCon Discovery GmbH, Potsdam, Germany  
eleakovic@fkit.unizg.hr

Raspberry ketone is a natural phenolic compound found in the red raspberry (*Rubus idaeus*) and is widely used in the food and cosmetics industry.[1] The amount of raspberry ketone in the fruit is low.[2] A promising production method is a biocatalytic process that uses as substrate rhododendrol glycosides, e.g., betuloside, precursors found in the inner birch bark. The hydrolysis of rhododendrol glycosides results in the (R)- and (S)- rhododendrol, which can be enzymatically converted to raspberry ketone.[3]

In this work, the reaction of betuloside hydrolysis by  $\beta$ -glucosidase from almonds (Figure 1.) was investigated. The kinetic parameters were estimated under the optimal conditions ( $T = 40$  °C, 0.1 M KPi  $pH = 6$ ). To validate the developed mathematical model and the estimated kinetic parameters, total of four reactions were carried out in three different reactor types: batch reactor (low and high substrate concentration), repetitive batch reactor and ultrafiltration membrane reactor.

- [1] C. Morimoto et al., Life Sciences 77 (2005) 194-204.  
[2] M. Larsen et al., Acta Agric. Scand 41 (1991) 447-454.  
[3] Becker et al., Appl. Microb. Biotechnol. 105 (2021) 4189-4197.

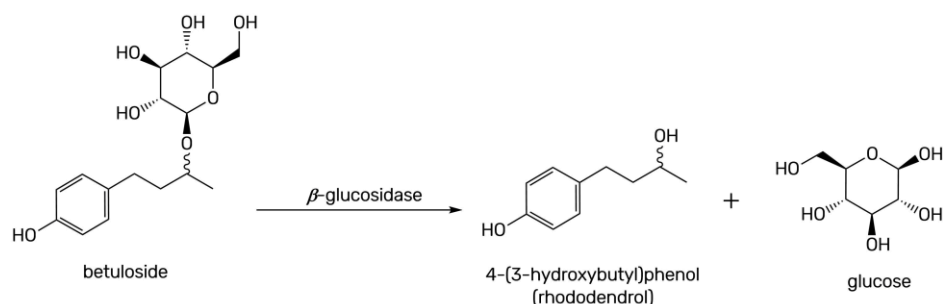

Figure 1. The reaction scheme

## BIOINSPIRED SOLVENTS: DEEP EUTECTIC SOLVENTS BASED ON OSMOLYTES FOR STABILIZATION OF ENZYMES

**Marijan Logarušić, Mia Radović, Ivana Radojčić Redovniković, Marina Cvjetko Bubalo**

University of Zagreb Faculty of Food Technology and Biotechnology, Pierottijeva ulica 6, 10000 Zagreb, Croatia  
mlogarusic@pbf.hr

Over the past decade, deep eutectic solvents (DES) have gained significant attention for their potential to improve the efficiency and sustainability of various processes. With features like low volatility, non-flammability, and minimal toxicity, these solvents are derived from readily available natural resources, eliminating the need for traditional solvents. Their exceptional characteristic lies in their remarkable adaptability, allowing for the customization of solvent design to meet specific industrial requirements. If sourced from natural origins, DES can replicate environments conducive to a variety of biomolecules. In both dehydrated and aqueous states, they not only facilitate the dissolution of diverse biomolecules but also stabilize commercially significant natural compounds, such as DNA, bioactive substances, and proteins, achieved by inducing specific molecular conformations [1].

In a recent exploration, we delved into the realm of naturally occurring osmoprotectants—small molecules generated in cells in response to external stimuli [3]. We analyzed the natural distribution patterns of these osmolytes to create innovative osmolyte-based deep eutectic solvents (DES). Subsequently, the prepared DES underwent characterization in terms of cytotoxicity and testing to assess their potential in stabilizing a model protein (lysozyme) and industrially valuable enzymes like dehydrogenases and transaminases. The results indicate that osmolyte-based DES, with their inherent variability, have the ability to significantly and durably stabilize enzymes stored at various temperatures compared to presently known DES and standard storage buffers.

- [1] Y. Liu et al., *J. Nat. Prod.* (2018) 81 679-690.  
[2] M. Cvjetko Bubalo et. al., *Green Chem.* (2023) 25 3398-3417.

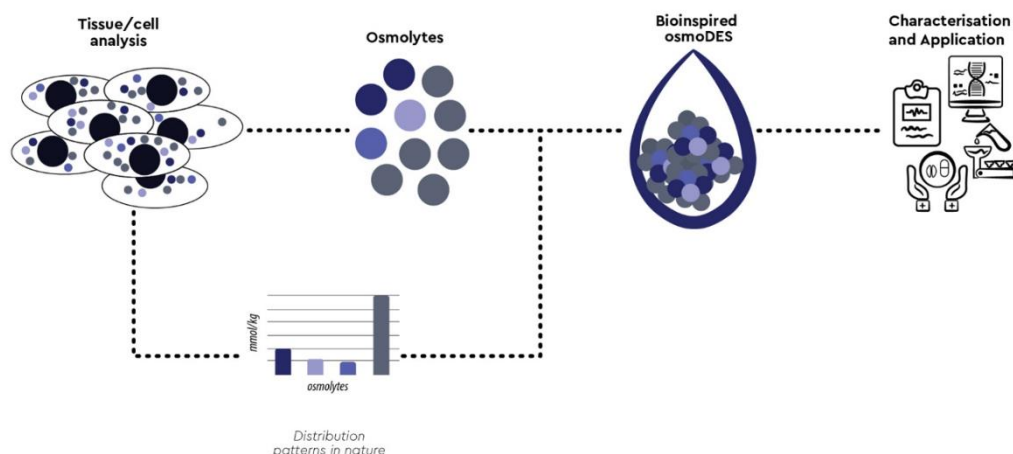

# POTENTIAL OF PORTABLE NEAR INFRARED SPECTROMETER FOR MONITORING PHYSICAL-CHEMICAL PROPERTIES OF *Spirulina platensis* AQUEOUS EXTRACTS

**Blaženko Marjanović, Tea Sokač Cvetnić, Davor Valinger, Maja Benković, Tamara Jurina, Jasenka Gajdoš Kljusurić, Ana Jurinjak Tušek**

University of Zagreb Faculty of Food Technology and Biotechnology, Pierottijeva 6, 10000 Zagreb, Croatia  
blazenko.marjanovic4@gmail.com

*Spirulina platensis* microalga has become recognized as a promising source of highly nutritious food components to feed the growing global population. Because of its high protein content (up to 70% w/w) [1], abundance of essential amino acids, and excellent digestion, it is employed in human nutrition and there is growing interest in analysing bioactive compound present in *Spirulina platensis* microalga. In this work, portable near infrared (NIR) spectrometer was used for monitoring of physical-chemical properties (extraction yield (EY), total polyphenols concentration (TPC), total proteins concentration (TP), antioxidant activity measured by (i) DPPH method (DPPH) and (ii) FRAP method (FRAP)) of *Spirulina platensis* aqueous extracts. Ultrasound-assisted aqueous extraction (ultrasonic bath with an ultrasound frequency of 35 kHz) of bioactive molecules from *Spirulina platensis* was performed throughout 30 independent experiments. NIR spectra were recorded in the wavelength range of 900–1700 nm. Raw NIR spectra were subjected to the physical-chemical properties applying Principal Component Analysis (PCA) and Artificial Neural Network (ANN) modeling. The results showed that ANN model (MLP 5-10-5), developed on PCA coordinated of NIR spectra of extracts samples, can efficiently ( $R^2_{\text{training}} = 0.9253$ ,  $R^2_{\text{test}} = 0.8613$ ,  $R^2_{\text{validation}} = 0.8261$ ) simultaneously describe all five analyzed extracts properties ( $R^2_{\text{validation}}(\text{EY}) = 0.9497$ ,  $R^2_{\text{validation}}(\text{TPC}) = 0.8633$ ,  $R^2_{\text{validation}}(\text{DPPH}) = 0.9147$ ,  $R^2_{\text{validation}}(\text{FRAP}) = 0.9171$  and  $R^2_{\text{validation}}(\text{TP}) = 0.8857$ ). Therefore, NIR spectroscopy coupled with ANN modeling was shown to be a valuable tool for fast, nondestructive and reproducible monitoring of physical-chemical properties of *Spirulina platensis* aqueous extracts.

- [1] T. Lafarga et al., *Foods Res. Int.* 137 (2020) 109356.  
[2] S. Tavakoli et al., *Algal Res.* 60 (2021) 102493.

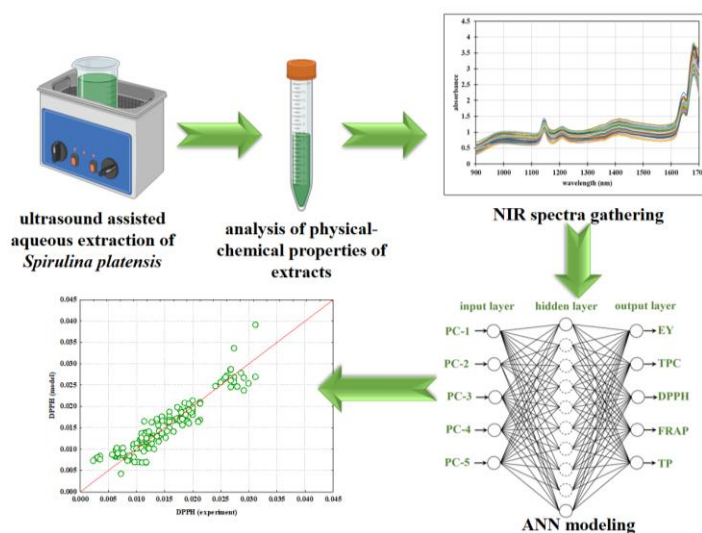

## ENZYMATIC MODIFICATION OF SOPHOROLIPID MOLECULE

**Lorena Mateša<sup>1</sup>, Martina Sudar<sup>1</sup>, Etienne Séverac<sup>2</sup>, Magali Remaud-Siméon<sup>2</sup>, Zvezdana Findrik Blažević<sup>1</sup>**

<sup>1</sup> University of Zagreb Faculty of Chemical Engineering and Technology, Savska c. 16, 10000 Zagreb, Croatia

<sup>2</sup> Toulouse Biotechnology Institute (TBI), Université de Toulouse, CNRS, INRAE, INSA, 135, Avenue de Rangueil, CEDEX 04, F-31077 Toulouse, France

lmatesa@fkit.unizg.hr

Glycolipids are a group of low molecular weight biosurfactants, amphiphilic molecules comprised of saccharide part as well as lipid moiety [1]. The four biotechnologically important groups of microbial glycolipids are rhamnolipids, sophorolipids, trehaloselipids and mannosylerythritolipids [2]. Sophorolipids contain the disaccharide sophorose and may be present in two forms, the lactonic and the open acid form [3]. The main producers are yeast species belonging to the *Starmerella* class. They synthesise sophorolipids as a mixture of molecules that differ in the fatty acid part, in the acetylation pattern as well in lactonization [4]. Owing to the non-pathogenic character of the production host and high yields, there is quite some interest in these molecules. So far, sophorolipids have found their application in real life products and are available in the market, though further research is needed in order to broaden their application range, either by evaluating their behaviour in new application or by modifying their chemical structure. Biologically derived sophorolipids can be modified by chemo-enzymatic processes [5]. Enzymatic modifications can incorporate new functional groups to naturally derived sophorolipids, enhancing some specific properties and their performance. The high regioselectivity and stereospecificity of enzymes reduces protection and purification steps of conventional syntheses and minimizes the use of environmentally unfriendly solvents [6].

Development of biocatalytic process must take into account enzyme kinetics and enzyme operational stability, which should be measured under conditions easily reproducible at a larger scale. Strategy for development of such process combines enzyme kinetic modelling and reactor modelling. Once the mathematical model of a process is obtained, it can be used to determine the optimum reaction conditions for desired outcomes [7].

In this study, preliminary data for enzymatic modification of sophorolipid molecule will be presented. The influence of pH and temperature on enzyme activity was measured and kinetic measurements were carried out.

---

55

- [1] I. M. Banat et al., Appl. Microbiol. Biotechnol. 87 (2010) 427-444.
- [2] V. Dembitsky, Chem. Biodivers. 1 (2004) 673-781.
- [3] A. Nunez et al., J. Chromatographia. 53 (2001) 673-677.
- [4] A. M. Davila et al., J. Chromatogr. 648 (1993) 139-149.
- [5] N. Kosaric et al., Biosurfactants: Production and Utilization-Processes, Technologies, and Economics 1st edn. CRC Press 2014.
- [6] K. M. J. Saerens et al., Biotechnol. J. 4 (2009) 517-524.
- [7] Vasić-Rački, Đ., Appl. Microbiol. Biotechnol. 2011, 91, 845-856.

This project has received funding from the European Union's Horizon 2020 research and innovation programme under grant agreement No 101000560 (RadicalZ).

# COMPOSITE EDIBLE FILMS BASED ON CITRUS PECTIN AND CHICKPEA PROTEINS – CHARACTERIZATION AND APPLICATION FOR FRESH-CUT FRUIT COATING

**Dušan Pećanac<sup>1</sup>, Milica Perović<sup>1</sup>, Marija Kostić<sup>2</sup>, Mirjana Antov<sup>1</sup>**

<sup>1</sup>University of Novi Sad, Faculty of Technology, Boulevard cara Lazara 1, 21000 Novi Sad, Serbia

<sup>2</sup>University of Novi Sad, Institute BioSense, Dr Zorana Đinđića 1, 21000 Novi Sad, Serbia  
pecanac.3.20.p@uns.ac.rs

Composite edible films represent biodegradable material that can be build up from natural polymers such as proteins and polysaccharides. These materials, when released into the environment, are converted into simple compounds that do not harm the biosystem [1]. Generally, the use of such films could be a promising alternative to regular plastic films, which are used in many areas such as medical, pharmaceutical and food industry. The main aims of implementing edible films instead of synthetic plastics in food packing and preservation are to extend shelf-life of products and reduce environmental problems. This work aims to characterize edible films composed of commercial citrus pectin, and protein fractions, albumin and globulin, which were isolated from chickpea. The composition of films had an effect on their characteristics analysed by FTIR and SEM. In addition, properties of composite edible films were determined regarding their ABTS radical scavenging activity and water vapor permeability. The thickness of films was significantly increased when protein fractions were incorporated in comparison to control film with pectin. The lowest water vapor permeability values were determined for the pectin/albumin based films. Furthermore, coating of fresh-cut fruits with composite edible films had positive effect on prolonging shelf-life and freshness in comparison to uncoated ones.

[1] Chandra R., Rustgi R., Progress in Polymer Science, 1998, 23 (7), 1273-1335.

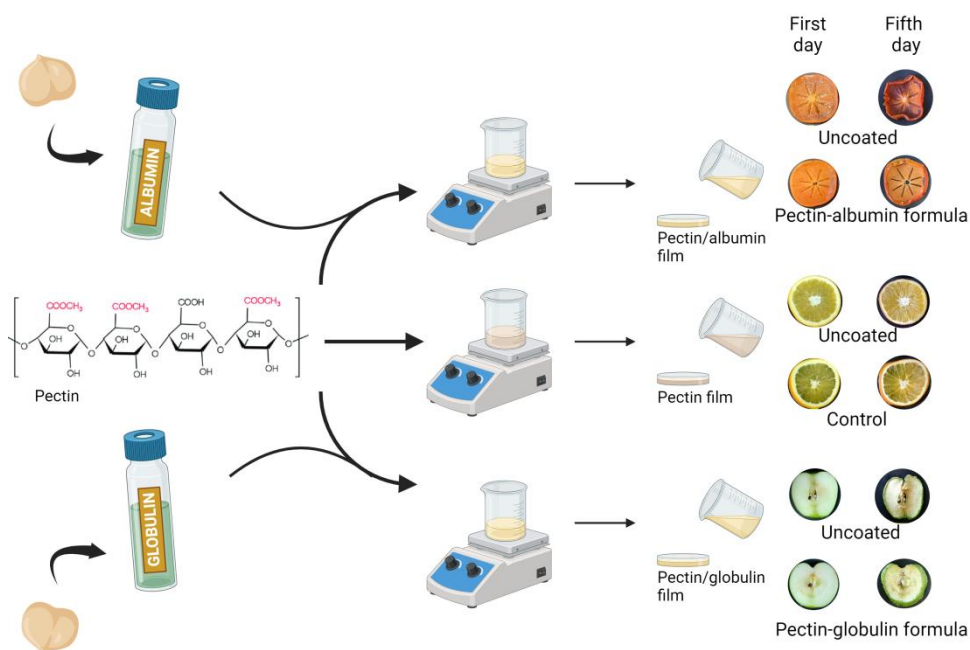

## PROIZVODNJA PREKURSORA STATINA IMOBILIZIRANIM ENZIMOM U KONTINUIRANIM REAKTORIMA

### PRODUCTION OF STATIN PRECURSORS BY IMMOBILIZED ENZYME IN CONTINUOUS REACTORS

**Dino Skendrović<sup>1</sup>, Martina Batur<sup>1</sup>, Ivan Karlo Cingesar<sup>1</sup>, Maja Leitgeb<sup>2</sup>, Katja Vasić<sup>2</sup>, Mateja Primožič<sup>2</sup>, Ana Vrsalović Presečki<sup>1</sup>**

<sup>1</sup>Sveučilište u Zagrebu Fakultet kemijskog inženjerstva i tehnologije, Trg Marka Marulića 19, 10000 Zagreb, Hrvatska

<sup>2</sup>Univerza v Mariboru, Fakulteta za kemijo in kemijsko tehnologijo, Smetanova ulica 17, 2000 Maribor, Slovenija  
dskendrov@fkit.unizg.hr

Statini su skupina lijekova koji se koriste za snižavanje razine kolesterola u krvi. Svi statini sadrže isti bočni lanac (3*R*, 5*R/S*)-dihidroksiheksanoat, koji se u industrijskoj proizvodnji može dobiti kemijskim ili biokatalitičkim putovima sinteze. Biokatalitički put za sintezu prekursora bočnog lanca statina pomoću 2-deoksiriboza-5-fosfat aldolaze (DERA, EC 4.1.2.4) nudi mnoge prednosti u odnosu na standardnu kemijsku sintezu, ali njen glavni problem je inaktivacija enzima reakcijskim supstratima i međuproduktom. Postoji više načina kako pristupiti tom problemu, a neki od najčešće korištenih su imobilizacija enzima na čvrsti nosioc te njihova upotreba u kontinuiranim reaktorskim sustavima. Imobilizacija enzima uključuje vezanje enzima na čvrsti nosioc, što može dovesti do povećanja stabilnosti uz zadržavanje većine aktivnosti enzima. Nosioc za imobilizaciju mora imati veliku specifičnu površinu koja je podložna funkcionalizaciji kemijskim skupinama na koje će se vezati enzim, treba biti kemijski i mehanički stabilan te kompatibilan s reakcijskim medijem, pri čemu mezoporozna silika ispunjava sve navedene uvjete. Kontinuirani reaktori omogućuju bolju kontrolu tijeka i brzine reakcije čime je moguće izbjeći nakupljanje međuprodukta u reaktoru. U ovom radu je ispitana sinteza statina katalizirana imobiliziranim enzimom DERA u cijevnom kontinuiranom reaktoru s nasutim slojem katalizatora. Enzim je imobiliziran na mezoporoznu siliku funkcionaliziranu pomoću (3-aminopropil)trimetoksilana (APTMS) te aktiviranu s anhidridom jantarne kiseline. Kontinuirani reaktori volumena 300 i 600  $\mu\text{L}$  izrađeni su metodom proizvodnje rastaljenim filamentom na 3D-pisaču. Ispitan je utjecaj različitih protoka na nastanak međuprodukta i produkta reakcije. Na temelju izmjerenih vrijednosti, izračunati su procesni pokazatelji, konverzija  $X$  i produktivnost  $Pr$ , pri različitim načinima provođenja procesa.

57

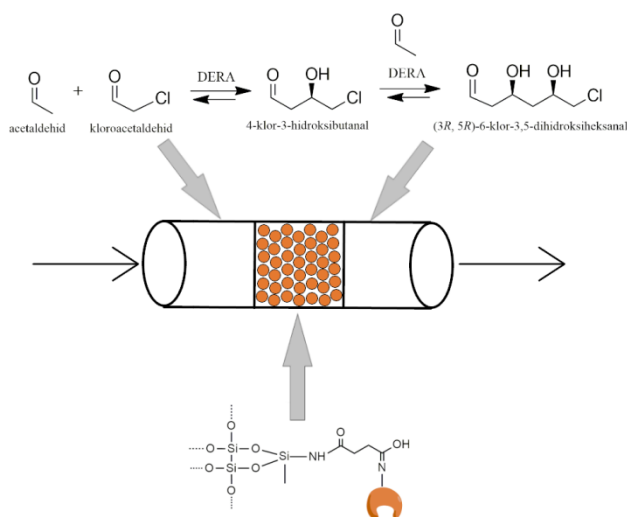

Slika 1. Ilustracija tijeka sinteze prekursora statina uz imobilizirani enzim u reaktoru s nasutim slojem katalizatora

## PENICILLIN DEGRADATION PATHWAY BY IMMOBILIZED $\beta$ -LACTAMASE

**Katja Vasić<sup>1</sup>, Mateja Primožič<sup>1</sup>, Željko Knez<sup>1,2</sup>, Maja Leitgeb<sup>1,2,\*</sup>**

<sup>1</sup>University of Maribor, Faculty of Chemistry and Chemical Engineering, Laboratory of Separation Processes and Product Design, Smetanova ulica 17, 2000 Maribor, Slovenia

<sup>2</sup>University of Maribor, Faculty of Medicine, Taborska ulica 8, 2000 Maribor, Slovenia  
katja.vasic@um.si

Environmental pollution caused by the abuse of various antibiotics and other pollutants has caused a serious threat to the ecological environment and human health, therefore development of effective strategies for degradation, as well as disposal of antibiotic residues in water is urgently needed.  $\beta$ -Lactam antibiotics are one of the most relevant drugs worldwide and have tremendously reduced the mortality associated with bacterial infections. Immobilized  $\beta$ -lactamase onto aminosilane magnetic nanoparticles (AMN-MNPs) was used for the degradation of penicillin (PEN). Thermal stability and reusability of such immobilized  $\beta$ -lactamase was investigated, as well as enzyme kinetics of free  $\beta$ -lactamase and immobilized  $\beta$ -lactamase was determined. Degradation study of PEN was performed with free and immobilized  $\beta$ -lactamase and analyzed using HPLC system.

The degradation study of PEN suggest that immobilized  $\beta$ -lactamase degrades PEN more efficiently than free enzyme, since it achieved 98% degradation of PEN after 24 hours, compared to free enzyme (22%). The influence of different PEN concentrations was investigated as well, indicating that higher concentrations of PEN slow down the degradation process. PEN with a concentration of 0.05 mg/mL was completely degraded by immobilized  $\beta$ -lactamase after 5 hours, while 45% degradation was achieved after 5 hours by immobilized  $\beta$ -lactamase with PEN concentration of 0.5 mg/mL. Finally, we lowered the concentration of PEN to 0.01 mg/mL and found that after 5 hours 96.11% was degraded, thereby confirming that the degradation of PEN occurs the fastest at a concentration of 0.05 mg/mL. The results show that such immobilized  $\beta$ -lactamase is thermally stable and can be reused for degradation of PEN, therefore providing an efficient tool for successful water treatments in order to ensure environmental safety and have an important practical significance in improving the environment and human health.

- [1] L. Yang et al., J. Hazard. Mater. 414 (2021) 125549.  
[2] L. Li et al., J. Dairy Sci. 97 (2014) 4052-4061.

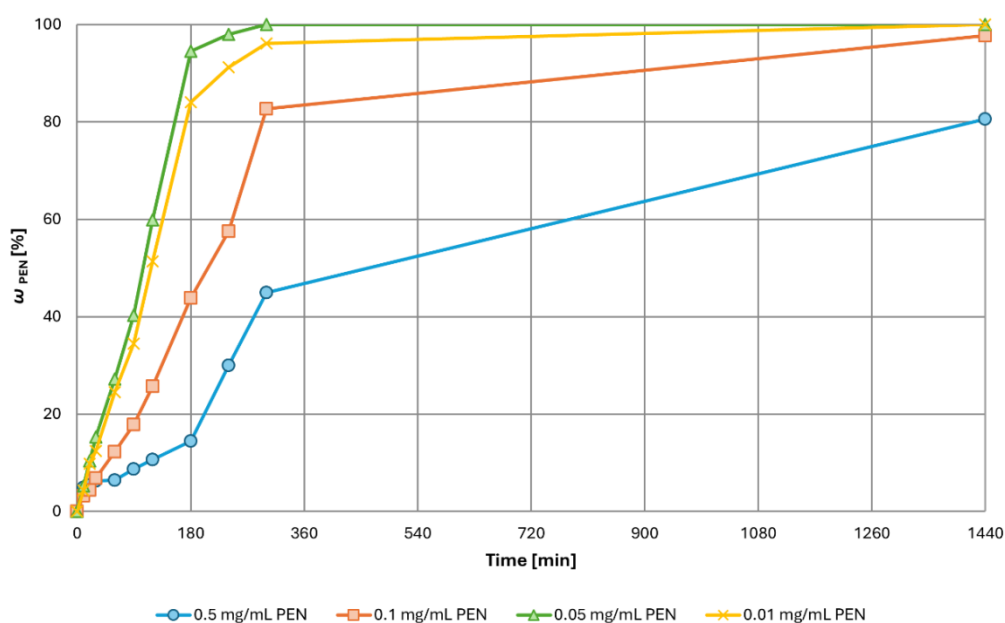

## HIGHLY EFFICIENT ENCAPSULATION OF ANTHOCYANINS BY COMPLEX COACERVATES FORMULATED FROM PECTIN AND CHICKPEA PROTEIN

**Jovana Vukobratović, Milica Perović, Mirjana Antov**

University of Novi Sad, Faculty of Technology, Boulevard cara Lazara 1, 21 000 Novi Sad, Serbia  
vukobratovic.87.20.b@uns.ac.rs

Complex coacervation occurs when two oppositely-charged molecules undergo an associative phase separation usually into a dense phase (the coacervate) and a dilute phase (the supernatant)[1]. One example of this fascinating phenomenon is the coacervation between proteins and polysaccharides via the electrostatic interactions. In this study coacervates were prepared from apple pectins polyanion and chickpea protein as polycation molecules. Proteins were extracted from chickpea by different protocols—by conventional alkaline extraction or by alkaline extraction assisted with  $\alpha$ -L-arabinofuranosidase. It is known that the complexation and the coacervate structure are highly influenced by the pH and mixing ratio; therefore, it was essential to determine the optimal pH and mixing ratio for the preparation of coacervates. The zeta potential was measured at range of pH values from 1 to 6, and mixing ratio pectin:protein was varied from 1:1 to 1:3. Additionally, the amount of anthocyanins bound by individual protein-pectin complex was determined. Results showed that applied conditions (mixing ratio 1:1, pH 2.6:2.8) led to the formation of stable coacervates with the ability to bind anthocyanins from aronia juice. The coacervates prepared with proteins extracted by alkaline extraction and arabinofuranosidase-assisted alkaline extraction bound 55% and 49% of anthocyanins, respectively. Results indicated great potential of studied pectin-protein coacervates for the encapsulation of bioactives and their control delivery.

[1] C. E. Sing and S. L. Perry, 16 (2020) 2285-2914.

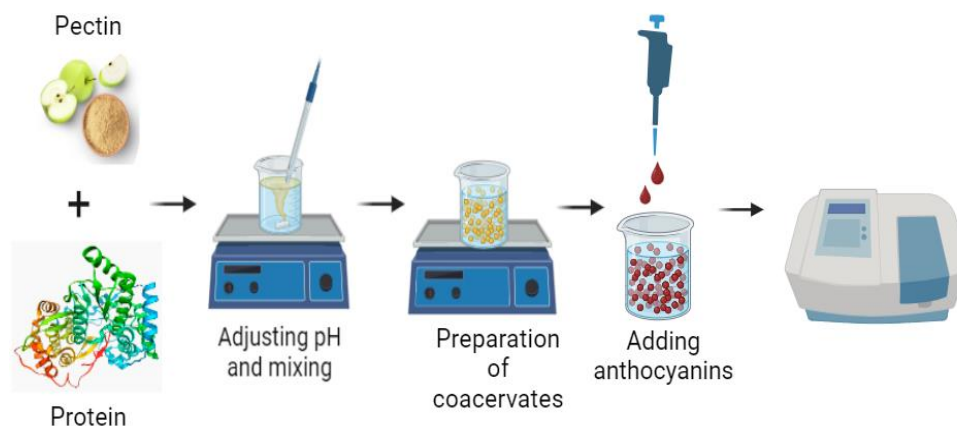



**Ekoinženjerstvo**  
*Environmental engineering*

## DETERMINATION OF ECOTOXICITY OF PHENOLS, RHODANIDES AND CYANIDES

**Nera Bebek, Lucija Vrbić, Ana Tutić, Martina Miloloža, Dajana Kučić Grgić**

University of Zagreb Faculty of Chemical Engineering and Technology, Trg Marka Marulića 19, 10000 Zagreb, Croatia

nbebek@fkit.unizg.hr, lvrbic@fkit.unizg.hr

Coke is a solid fuel with a high calorific value, obtained by dry distillation of hard coal and used in various processes, including iron and steel production. The production of coke generates a large amount of toxic wastewater with a very complex composition, which is released into the environment due to inefficient processing and has extremely negative effects. [1] The main pollutants in wastewater from the coke industry are phenols, rhodanides and cyanides. In this work, the ecotoxicity of phenols, rhodanide and cyanide was investigated by performing an ecotoxicity test with the marine bacterium *Vibrio fischeri*. This toxicity test is based on the evaluation of the reduction of physiological activity, i.e. the determination of the inhibition of the bioluminescence of the bacterium. The concentrations of phenols, rhodanide and cyanide tested were: 100 mg/L, 75 mg/L, 50 mg/L, 25 mg/L, 10 mg/L and 1 mg/L. The test organism *Vibrio fischeri* was exposed to an increasing series of dilutions of the test substances according to a linear and/or geometric sequence. When comparing the results for the individual substances, the greatest ecotoxic effect was observed for cyanides at the highest concentration tested (INH = 99.81%). As the concentration of phenols and rhodanide increased, an increase in the inhibition of *Vibrio fischeri* bioluminescence was also observed. At the highest phenol concentration tested (100 mg/L), the inhibition was 70.93%, while at the same rhodanide concentration it was 37.85%. According to the Globally Harmonized System of Classification and Labeling of Chemicals (GHS), chemicals can be classified as highly toxic substances ( $EC_{50} \leq 1$  mg/L), moderately toxic substances ( $1$  mg/L  $< EC_{50} \leq 10$  mg/L), slightly toxic substances ( $10$  mg/L  $< EC_{50} \leq 100$  mg/L). Regarding the classification, cyanides are moderately toxic substances ( $EC_{50} = 1.80$  mg/L), while phenols are slightly toxic substances ( $EC_{50} = 22.21$  mg/L). However, for rhodanides, the  $EC_{50}$  value could not be estimated, but only  $EC_{20} = 14.90$  mg/L.

61

[1] A. Tutić et al., Kem. Ind. 72 (2023) 349–358

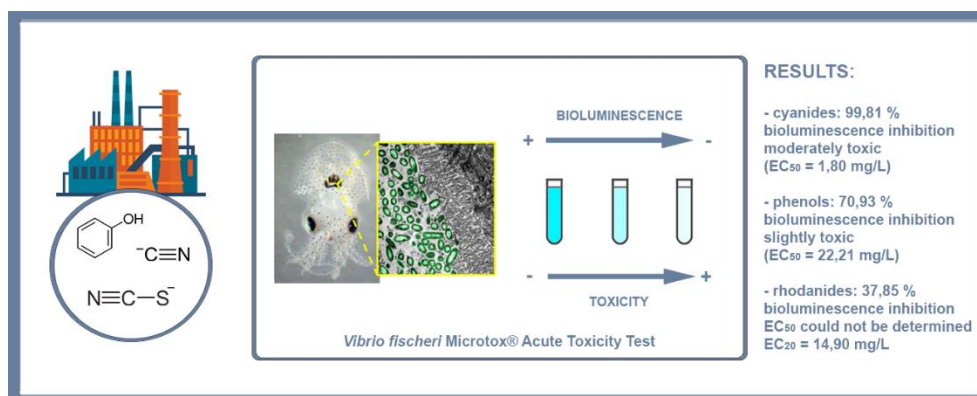

## DETERMINATION OF BIODEGRADABILITY OF BIOPOLYMERS

**Anthea Georgiev<sup>1</sup>, Martina Miloloža<sup>1</sup>, Vesna Očelić Bulatović<sup>1</sup>, Krešimir Stubić<sup>2</sup>, Dajana Kučić Grgić<sup>1</sup>**

<sup>1</sup>University of Zagreb Faculty of Chemical Engineering and Technology,  
Trg Marka Marulića 19, 10000, Zagreb, Croatia

<sup>2</sup>Aqua V.M.V. d.o.o., Ulica kralja Zvonimira 98, 10000 Zagreb, Croatia  
ageorgiev@fkit.unizg.hr

The increasing use of single-use plastics has led to a drastic increase in plastic waste and pollution and poses a significant threat to the environment. One of the possible solutions to reduce plastic pollution is the development of biodegradable polymers. Biodegradable materials can decompose under the influence of microorganisms, water, oxygen and sunlight. In this study, the biodegradability of a polymer blend of thermoplastic starch (TPS) and polylactide (PLA) was tested in soil with and without the addition of citric acid (CA) according to the ISO 14855 and ASTM D5338 standards. The experiment was guided by the basic principles of the circular model, which aims to reduce the depletion of natural resources, the accumulation of waste and the improper treatment of waste, which in turn has an impact on climate change and pollution. Before conducting the experiment, the soil was enriched with a suspension of a mixed culture of microorganisms to increase their number in the system. The experiment was carried out for 56 days at a constant temperature of 58 °C and humidity (>70 %). Changes in the mass of the material were monitored to confirm biodegradation. The polymer blends were characterized before and after the biodegradation experiment using infrared spectroscopy with Fourier transforms (FTIR-ATR). To investigate the morphological changes, the polymers were characterized by optical and polarization microscopy. When comparing the FTIR spectra before and after biodegradation, a decrease in the intensity of the peaks as well as a shift of the peaks to higher values was observed, which proves the biodegradation of the polymer matrices. The colonization of microorganisms on the surface of polymer materials was observed microscopically, which is an important step for the biodegradation of polymers. This study underlines the importance of using biodegradable polymer materials to reduce plastic pollution.

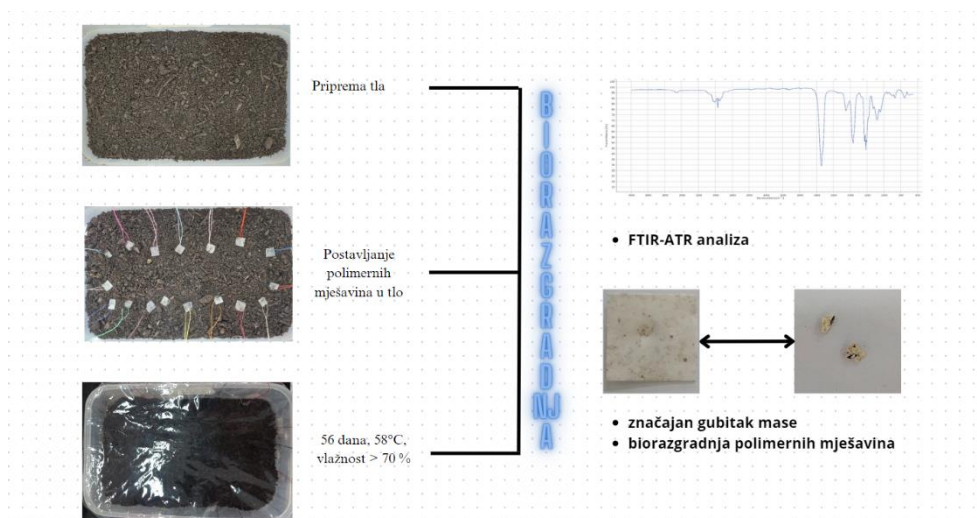

# SINTEZA I KARAKTERIZACIJA MEZOPOROZNE SILIKE RAZLIČITIH VELIČINA PORA ZA IMOBILIZACIJU ENZIMA

## SYNTHESIS AND CHARACTERIZATION OF MESOPOROUS SILICA OF VARIABLE PORE SIZES FOR ENZYME IMMOBILIZATION

**Dora Hećimović, Filip Mikuličić, Karla Stražičić, Dino Skendrović, Ana Vrsalović Presečki**

Sveučilište u Zagrebu Fakultet kemijskog inženjerstva i tehnologije, Trg Marka Marulića trg 19, 10000 Zagreb, Hrvatska  
dhecimovi@fkit.unizg.hr

Imobilizacija enzima predstavlja ključan postupak u proizvodnji heterogenih biokatalizatora. Enzim se veže na čvrsti i stabilni nosač, prelazeći iz topivog u netopivi oblik. Enzim 2-deoksiriboza-5-fosfat aldolaza (DERA) je enzim koji ima specifični afinitet aldolnih reakcija, zbog čega se koristi za sintezu različitih biokemijskih spojeva kao što su 63tatin i drugi aktivni farmaceutski spojevi. DERA je u postupku sinteze statina inaktivirana supstratom i produktom što predstavlja problem pri provođenju reakcije. Jedan od načina na koji se to može riješiti je imobilizacija enzima na čvrstu podlogu pri čemu je moguće poboljšati stabilnost enzima bez značajnog utjecaja na njegovu aktivnost. Mezoporozna silika je pogodan nosač zbog svoje velike specifične površine, uske raspodjele veličine pora te kemijske i toplinske stabilnosti. Metode koje se koriste za imobilizaciju enzima su kovalentno vezivanje enzima na nosač, fizikalna adsorpcija, imobilizacija enzima umrežavanjem i zarobljavanje enzima.

U ovom radu sintetizirana je mezoporozna silika s tri različite veličine pora. Čestice su funkcionalizirane pomoću (3-aminopropil)trimetoksilana (APTMS) i potom aktivirane anhidridom jantarne kiseline. Kako bi se potvrdila uspješnost sinteze i funkcionalizacije napravljene su karakterizacije na sljedećim uređajima; Skenirajući elektronski mikroskop (SEM), infracrvena spektroskopija s Fourierovom transformacijom (FTIR) i Brunauer-Emmett-Teller (BET) fiziosorpcija. Enzim je zatim imobiliziran kovalentnim vezanjem na nosioci te su ispitani parametri stabilnosti, očuvane aktivnosti i iskorištenja imobiliziranog enzima za svaku vrstu sintetizirane silike.

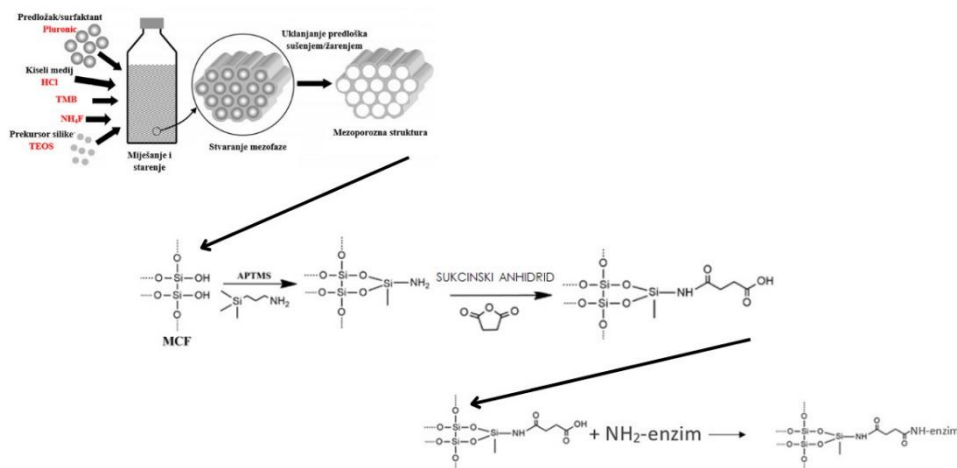

Slika 1. Tijek sinteze, funkcionalizacije i aktivacije čestica mezoporozne silike te imobilizacije enzima.

# OPTIMISATION OF THE ACCELERATED SOLVENT EXTRACTION METHOD FOR ORGANIC COMPOUNDS BOUNDED TO AIRBORNE PARTICULATE MATTER

**Tajana Horvat, Ivana Jakovljević, Zdravka Sever Štrukil, Gordana Pehnc**

<sup>1</sup>Institute for Medical Research and Occupational Health, Ksaverska c. 2, 10000 Zagreb, Croatia  
thorvat@imi.hr

Organic pollutants such as polycyclic aromatic hydrocarbons (PAH) are widely distributed and can have carcinogenic and mutagenic effects on human health, which is why it is vital to measure their presence in the air. To improve the extraction of organic compounds from airborne particulate matter (by automation, decreased extraction times, and consumption of the amount of solvent), various extraction methods have been established, including Soxhlet extraction, ultrasonic liquid extraction (ULE), and nowadays accelerated solvent extraction (ASE). ASE has been shown to be the fastest extraction technique. For the optimization of the most acceptable conditions for ASE extraction methods, four conditions were optimized in this research: extraction solvent (dichloromethane: acetone 1:1, n-hexene: dichloromethane 1:1, toluene, toluene: cyclohexene 7:3), temperature (60-150 °C), extraction cycles (1 – 4 cycle), and extraction flushing volume (50 – 90%). These conditions were variable, but others, such as pressure (1500 psi), purge time (60 s), static time (5 min) were invariable. Model samples were quartz filters which are usually used for airborne particulate matter sampling (Whatman), spiked with known concentrations of a certificate standard of eleven polycyclic aromatic hydrocarbons (EPA 610 PAH standard). For analysis of PAHs, an Agilent Infinity high-performance liquid chromatograph (HPLC) with a fluorescence detector was used. The analysis included the following PAHs: fluoranthene (Flu), pyrene (Pyr), benzo(a)anthracene (BaA), chrysene (Chry), benzo(b)fluoranthene (BbF), benzo(k)fluoranthene (BkF), benzo(a)pyrene (BaP), dibenzo(ah)anthracene (DahA), benzo(ghi)perilene (BghiP) and indeno(1,2,3,cd)pyrene (IP). A solvent mixture of toluene and cyclohexene (7:3) obtained the best recovery for all of the measured PAHs. For this solvent mixture the lowest recoveries of PAHs were determined for flushing cell volume of 50 %, while the highest recovery results were obtained with 80 % of cell volume, but this yielded somewhat worse recoveries for Flu and Pyr. The best recovery results for all of the PAHs were with 70 % flushing volume and 2 extraction cycles at 125 °C; for these conditions recoveries ranged from 87.7 % for Pyr to 99.3 % for DahA and BghiP.

64

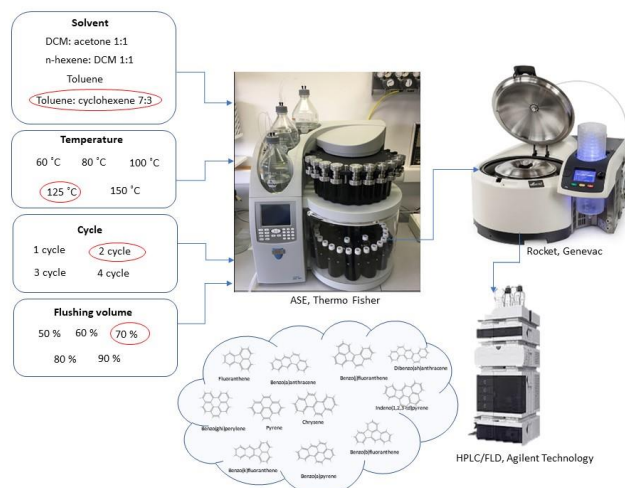

## DETERMINATION OF ECOTOXICITY OF PHENOL WITH *Chlorella* sp. AND *Pseudomonas putida*

**Leona Kuzmić, Ana Tutić, Martina Miloloža, Dajana Kučić Grgić**

University of Zagreb Faculty of Chemical Engineering and Technology, Trg Marka Marulića 19, 10000 Zagreb, Croatia  
lkuzmic@fkit.unizg.hr

In recent years, the emission of industrial wastewater has increased. Given the extremely wide industrial use of phenol, phenolic compounds are present in large quantities in wastewater. The presence of phenol in water can have toxic effects as a result of anthropogenic and natural activities. Phenols are most frequently bioaccumulated by natural processes and can disturb the bioecological balance. Even at low concentrations, phenols can have a negative impact on human health, while short-term exposure to high concentrations can lead to poisoning. Due to the high reactivity of phenol in the water medium, which is due to the presence of the hydroxyl group, phenolic compounds interact with inorganic components of the water environment and microorganisms. Ecotoxicological studies are carried out to assess the effects of phenol on aquatic organisms.

In this work, the influence of phenol ecotoxicity on two microorganisms, the microalgae *Chlorella* sp. And the bacterium *Pseudomonas putida*, was investigated. The initial concentrations of phenol were: 100 mg/L, 75 mg/L, 50 mg/L, 25 mg/L, 10 mg/L and 1 mg/L. The tests were carried out in Erlenmeyer flasks with a working volume of 25 ml for microalgae and 50 ml for bacterium. During the experiment, the number of living cells (CFU) of the microalgae or bacterium was measured on day 0, 1, 2 and 3. The aim of the study was to determine the growth inhibition of microalgae and bacterium during exposure to phenols. The percentage growth inhibition of the microalgae *Chlorella* sp. After 72 hours was 5.31%, while the growth inhibition of *Pseudomonas putida* was 3.23%. In view of the low growth inhibition values (<10%), it can be concluded that phenol had a neglected effect on the test organisms.

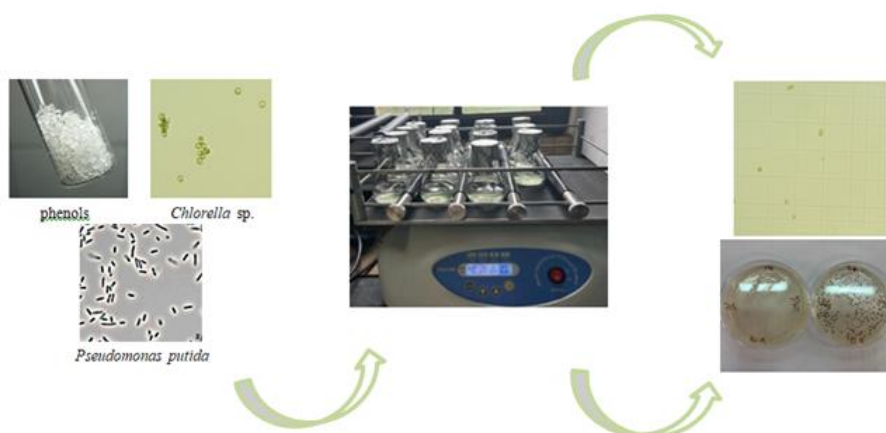

## ANALYZING AIR QUALITY: A SOURCE APPORTIONMENT STUDY IN ZAGREB, CROATIA

**Nikolina Račić<sup>1</sup>, Mario Lovrić<sup>2</sup>, Teo Terzić<sup>3</sup>, Ivana Jakovljević<sup>1</sup>, Jasmina Rinkovec<sup>1</sup>, Silva Žužul<sup>1</sup>, Zdravka Sever Štrukil<sup>1</sup>, Gordana Pehnc<sup>1</sup>**

<sup>1</sup>Institute for Medical Research and Occupational Health, Ksaverska cesta 2, 10000 Zagreb, Croatia

<sup>2</sup>Institute for Anthropological Research, Gajeva ul. 32, 10000 Zagreb, Croatia

<sup>3</sup>Ascalia d.o.o., Trate 16, 40000 Čakovec, Croatia  
nracic@imi.hr

Air pollution is a globally significant and pressing issue with serious consequences for human health and the environment. The polycyclic aromatic hydrocarbons (PAHs) and metals present in particulate matter emerge as primary contributors to the health risks associated with this environmental challenge.

This paper presents a comprehensive analysis of meteorological parameters (average temperature, wind speed, precipitation and pressure), gas consumption data and the concentrations of pollutants (NO<sub>2</sub>, PAHs and metals in the PM<sub>10</sub> fraction of particulate matter) at four air quality measurement stations. During a period of four years, from 2017 to 2020, daily samples of PM<sub>10</sub> (particulate matter with a diameter less than 10µm) were collected, along with their metal content including Arsenic (As), Cadmium (Cd), Lead (Pb), Manganese (Mn), Iron (Fe), Copper (Cu), and Zinc (Zn). Simultaneously, concentrations of polycyclic aromatic hydrocarbons (PAHs) in PM<sub>10</sub>, such as Benzo(a)pyrene (BaP), Benzo(a)anthracene (BaA), Benzo(ghi)perylene (BghiP), Dibenzo(ah)anthracene (DahA), Chrysene (Chry), Benzo(k)fluoranthene (BkF), Benzo(b)fluoranthene (BbF), Benzo(j)fluoranthene (BjF), Fluoranthene (Flu), and Pyrene (Pyr), were also measured as well as nitrogen oxide concentrations (NO<sub>2</sub>).

Using statistical techniques and Python models, this study investigates potential associations and quantifies the relationship between the variables and revealed potential sources of pollution. The statistical techniques comprised correlation analysis, Non-Negative Matrix Factorization (NMF), Principal Component Analysis (PCA) and linear regression. NMF analysis was employed to understand relationships among the variables and potential sources of pollutants. NMF results revealed different sources of pollutants in the studied area, grouping PAHs and metals into categories that represent potentially two main different sources of pollution – traffic emissions and heating.

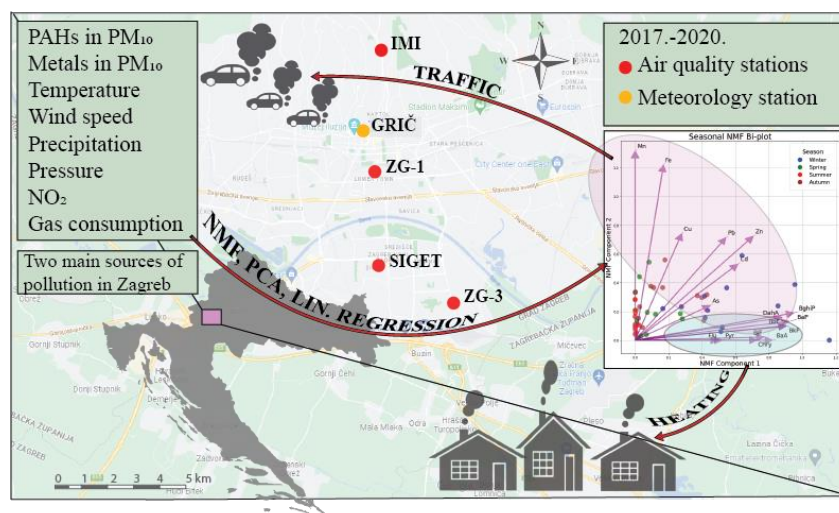

## SPATIAL DISTRIBUTION AND RISK ASSESMENT OF PCBs, OCPs AND PAHs IN FRESHWATER SEDIMENTS IN CROATIA

**Ivana Terzić<sup>1</sup>, Mario Lovrić<sup>2</sup>, Snježana Herceg Romanić<sup>3</sup>, Ivana Jakovljević<sup>3</sup>,  
Sanja Fingler<sup>3</sup>, Gordana Mendaš<sup>3</sup>, Sanja Stipičević<sup>3</sup>, Šime Ukić<sup>1</sup>**

<sup>1</sup>University of Zagreb Faculty of Chemical Engineering and Technology, Trg Marka Marulića 19, 10000 Zagreb, Croatia

<sup>2</sup>Institute for Anthropological Research, Gajeva ulica 32, 10000 Zagreb, Croatia

<sup>3</sup>Institute for Medical Research and Occupational Health, Ksaverska cesta 2, 10000 Zagreb, Croatia  
[inad@fkit.unizg.hr](mailto:inad@fkit.unizg.hr)

A comprehensive analysis of the toxicity, environmental persistence and bioaccumulation of toxic substances is one of the most important steps in the assessment of environmental risks. Polychlorinated biphenyls (PCBs), organochlorine pesticides (OCPs) and polycyclic aromatic hydrocarbons (PAHs) are released less into the environment today, but still have a high hazardous potential due to their PBT (persistent, bioaccumulative and toxic) properties. Sediments serve as an important indicator for the long-term monitoring and assessment of pollution status due to their ability to accumulate these pollutants. This work is focused on a deeper understanding of the distribution of PCBs, OCPs and PAHs in the freshwater sediments of Croatia, which represents a significant ecosystem for such investigations. In silico toxicity assessment with VEGA QSAR models, along with the evaluation of TU (Toxic Units) and PBT properties<sup>1</sup>, forms the basis for multidimensional environmental risk assessment of these pollutants. The application of advanced statistical methods such as Principal Component Analysis (PCA) and Cluster Analysis (CA), enables a thorough analysis and interpretation of the data.

The review of PBT scores highlights certain locations with increased ecological risks: Metković (the bridge on the Neretva River) with high concentrations of fluoranthene and pyrene, indicating industrial pollution; Zagreb (near Savski Kamenji and near the heating plant) with elevated levels of fluoranthene, possibly due to urban and industrial emissions; Sisak (river Kupa near the Old Town) with significant concentrations of PAHs and PCBs, indicating industrial influences; Petrinja (bathing area) and Karlovac (city center along the Kupa River) with high levels of the carcinogen benzo[a]pyrene. Sediment samples containing compounds with high PBT scores, such as PCB-180 and PCB-189, require special attention due to their pronounced persistence and potential toxicity. These findings underscore the need for detailed ecological monitoring and continuous management to maintain water quality and protect the environment.

67

[1] S. Babić et al., Sci. Total Environ. 643 (2018) 435-450.

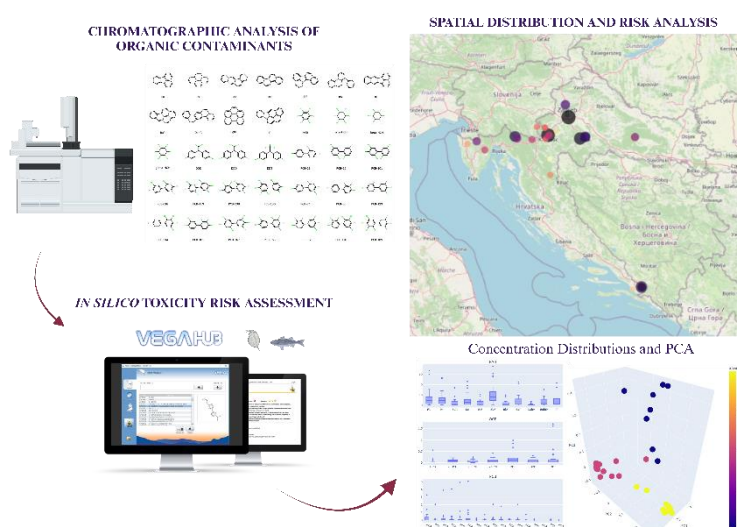



## BIOLOŠKA VALORIZACIJA REALNOG UZORKA ORGANSKE FRAKCIJE IZ MIJEŠANOG KOMUNALNOG OTPADA

### BIOLOGICAL VALORIZATION OF A REAL SAMPLE OF THE ORGANIC FRACTION OF MUNICIPAL SOLID WASTE

**Iva Turkalj<sup>1</sup>, Monika Šabić Runjavec<sup>1</sup>, Tomislav Domanovac<sup>2</sup>, Marija  
Vuković Domanovac<sup>1</sup>**

<sup>1</sup>University of Zagreb Faculty of Chemical Engineering and Technology,  
Trg Marka Marulića 19, 10000 Zagreb, Croatia

<sup>2</sup>IPZ Uniprojekt TERRA, Voćarska cesta 68, 10000 Zagreb, Croatia  
iturkalj@fkit.unizg.hr

Onečišćenje okoliša, rizik za javno zdravlje, degradacija tla, emisije metana i procjednih voda te klimatske promjene posljedice su nepravilnog gospodarenja otpadom. Poznavanje svojstava otpada ključno je za iskorištavanje njegovog potencijala, čija uporaba postaje ozbiljan izazov diljem svijeta. Količina i sastav organske frakcije iz miješanog komunalnog otpada (OFMKO) ovisi o geografskom položaju, broju stanovnika, gospodarskim aktivnostima, prehrambenim navikama, sezoni i sustavu sakupljanja. U Europskoj uniji ovakva frakcija smatra se mješavinom kuhinjskog otpada i otpada iz parkova i vrtova. Mogućnosti gospodarenja ovom frakcijom su usmjerene na stabilizaciju OFMKO-a primjenom različitih tehnologija temeljenih, ili na termičkim (npr. spaljivanje uz iskorištavanje energije), ili češće na biološkim procesima (kompostiranje, anaerobna digestija). U posljednje vrijeme istražuju se načini za valorizaciju OFMKO-a proizvodnjom novih proizvoda primjenom koncepta u kojem otpad koji je nastao u jednom procesu postaje sirovina u drugom procesu bez nastanka otpada. Karakterizacija OFMKO stoga predstavlja temeljnu informaciju za valorizaciju biorazgradivog otpada kao ključnog pokretača rasta biogospodarstva.

U ovom radu provedena je karakterizacija prosijane frakcije manje od 40 mm reprezentativnog realnog uzorka iz miješanog komunalnog otpada s područja središnje Hrvatske i jugozapadnog područja Istre. Rezultati pokazuju da udio biorazgradive organske frakcije u miješanom komunalnom otpadu je veći od 61,5 % uz visoku prosječnu vrijednost omjera BPK<sub>5</sub>/KPK od 0,80±0,05 što ukazuje na visok potencijal za biološku valorizaciju ispitivanog realnog uzorka OFMKO-a.



**Kemijsko inženjerstvo**  
*Chemical engineering*

## PRIMJENA TEHNOLOGIJE ADITIVNE PROIZVODNJE U RAZVOJU HETEROGENIH KATALIZATORA

### APPLICATION OF ADDITIVE MANUFACTURING IN THE DEVELOPMENT OF HETEROGENEOUS CATALYSTS

**Sara Anđelović, Željka Ćurić, Filip Car, Domagoj Vrsaljko, Vesna Tomašić**

Sveučilište u Zagrebu Fakultet kemijskog inženjerstva i tehnologije, Trg Marka Marulića 19, 10000 Zagreb, Hrvatska  
 sandelovi@fkit.unizg.hr, zcuric@fkit.unizg.hr

Napretkom tehnologije i povećanjem broja stanovnika na Zemlji, zagađenje zraka iz antropogenih izvora predstavlja sve veći problem kako za ljude tako i za okoliš. Hlapljivi organski spojevi su grupa organskih spojeva koji lako isparavaju u uvjetima sobne temperature i atmosferskog tlaka, a mogu imati negativan utjecaj na ljudsko zdravlje i okoliš. Skupina hlapljivih organskih spojeva koju čine monoaromatski ugljikovodici - benzen, toluen, etilbenzen te izomeri ksilena (*o*-ksilen, *m*-ksilen, *p*-ksilen), svrstavaju se u skupinu spojeva pod akronimom BTEX. Cilj ovog rada bio je razvoj monolitnog katalizatora s potencijalnom primjenom za katalitičku oksidaciju smjese aromatskih hlapljivih organskih spojeva (benzen, toluen, etilbenzen i *o*-ksilen; BTEX). Za pripremu monolitnog nosača katalizatora korištena je metoda stereolitografije koja se ubraja u skupinu naprednih tehnologija aditivne proizvodnje. Prednost korištene metode je njezina velika fleksibilnost i mogućnost pripreme različitih geometrija monolitnih nosača pogodnih za katalitičke primjene. Kao katalitički sloj korišten je miješani oksid mangana i željeza koji je na monolitni nosač nanesen metodom mokre impregnacije. U nastavku istraživanja ispitana je aktivnost pripremljenih monolitnih katalizatora provedbom oksidacije smjese BTEX-a pri različitim temperaturama i različitim vremenima zadržavanja reakcijske smjese u reaktoru. U završnom dijelu istraživanja provedeno je matematičko modeliranje i predložen je jednodimenzijski (1D) heterogeni model uz kinetički model reakcije prvog reda, koji je omogućio opisivanje promatranog reakcijskog sustava. Procijenjeni su ključni parametri modela te je provedena ocjena prihvatljivosti predloženog modela na temelju usporedbe eksperimentalnih rezultata i teorijskih vrijednosti dobivenih prema predloženom modelu. Nađeno je da predloženi model dobro opisuje promatrani eksperimentalni sustav. Također je ustanovljeno da 3D-ispisani ZDP model rezultira najboljim konverzijama modelnih komponenti.

70

Rad je nastao u okviru projekta INDIGO IP-2022-10-8004 (D. Vrsaljko) koji financira Hrvatska zaklada za znanost.

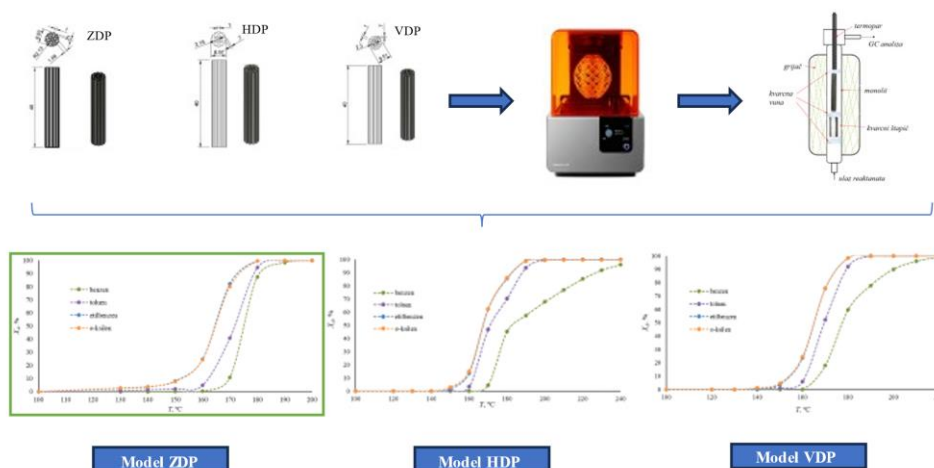

## USAGE OF WASTE GLASS IN THE CEMENT INDUSTRY

**Elma Bajrić<sup>1</sup>, Berina Hadžialić<sup>1</sup>, Zehrudin Osmanović<sup>1</sup>, Ervin Karić<sup>1</sup>, Damir Mulamehmedović<sup>2</sup>, Hanka Hadžić<sup>3</sup>**

<sup>1</sup>University of Tuzla, Faculty of Technology, Univerzitetska 8, 75000 Tuzla, Bosnia and Herzegovina

<sup>2</sup>Lukavac cement d.o.o., Lukavačkih brigada bb, 75300 Lukavac, Bosnia and Herzegovina

<sup>3</sup>Plastoflex d.o.o., Branilaca grada bb, 75320 Gračanica, Bosnia and Herzegovina

elmabajric033@gmail.com

A great portion of glass packaging, bottles, and containers, after fulfilling their primary purpose, face disposal rather than reuse. Despite being inert and non-toxic, glass takes an oddly long time to decompose, contributing to prolonged environmental pollution. Discarded glass containers participate in occupying space in landfills and fields. One of the primary obstacles lies in the segregation and collection process. Variations in glass types, colors, and impurities (non-glass materials) complicate the process. Limited provision and high transportation costs disturb the efficiency of recycling glass. This project is made to show a solution for decreasing the recycling dilemma. Usage of waste glass as a substitute for traditional  $\text{SiO}_2$  (which is also known as quartz or silica) in the process of cement production leads to waste reduction, sustainable manufacturing practices and reduction of toxic gases ( $\text{SO}_2$ ,  $\text{NO}_x$ ,  $\text{CO}$ ) in the atmosphere.

The experimental part of this work will be carried out in the laboratory of the Lukavac cement factory, the laboratory of the Faculty of Technology in Tuzla and the Institute of Civil Engineering IGH, Croatia. This project involves various analytical techniques, including spectrometry, volumetry, and granulometry. The quantity of carbon, sulfur, hydrogen, nitrogen and mercury will be measured, including the composition and quality of clinkers. Experimental data in the form of numbers will be presented – a database on the physical, chemical and mechanical characteristics of used glass as a raw material for cement production. Complete insight into the quantity and quality of used glass in Bosnia and Herzegovina will be shown, as well as a defined way of collecting, storing and purchasing glass.

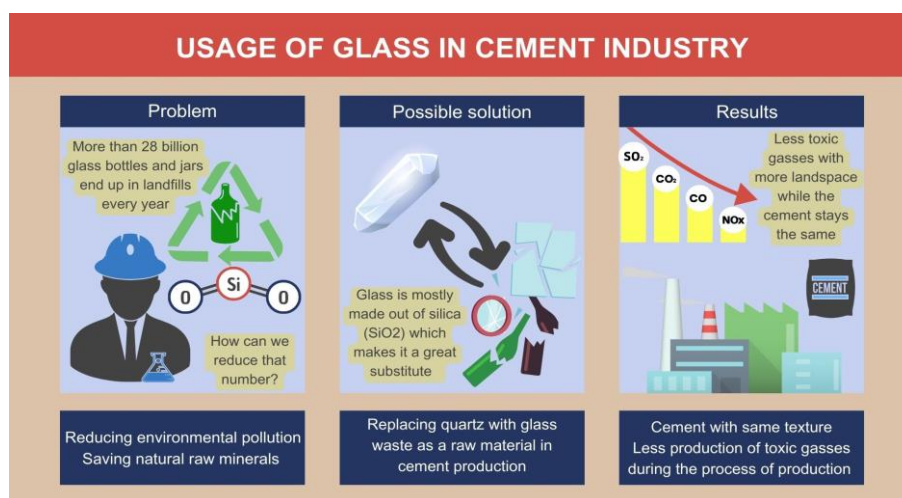

# THE INFLUENCE OF THE CATALYST TYPE AND THE REACTION PARAMETERS ON THE SYNTHESIS OF BIODIESEL FROM SELECTED SECONDARY ALCOHOLS

**Petra Batinić<sup>1</sup>, Antonio Cvetković<sup>1</sup>, Leona Čakić<sup>1</sup>, Mia Gotovuša<sup>1</sup>, Jelena Parlov Vuković<sup>2</sup>, Fabio Faraguna<sup>1</sup>**

<sup>1</sup>University of Zagreb Faculty of Chemical Engineering and Technology, Trg Marka Marulića 19, 10000 Zagreb, Croatia

<sup>2</sup>Ruđer Bošković Institute, Bijenička cesta 54, 10000 Zagreb, Croatia  
pbatinic@fkit.unizg.hr

Increase in the global population, energy demand, and climate changes have motivated researchers to explore alternative, renewable energy sources, e.g. biofuels. Biodiesel (fatty acid alkyl esters) is biofuel most commonly synthesized via transesterification reaction from vegetable oils or animal fats, and an alcohol (methanol or ethanol), in the presence of a catalyst, usually homogeneous alkaline catalyst (potassium or sodium hydroxide) [1]. Reaction conversion can be affected by different reaction parameters, i.e., reaction temperature, time, molar ratio of the reactants, as well as mass fraction and the type of the catalyst used in the synthesis [2]. Both reaction conversion and biodiesel's application properties depend on its structure, determined by the structural properties of the used reactants [3].

In this study, waste cooking oil was reacted with a selected secondary alcohol (e.g. 2-propanol, or 2-octanol), in the presence of a different catalysts (e.g. potassium hydroxide, sulfuric acid, or guanidine) to fatty acid alkyl esters. Reaction temperature was kept constant (60 °C), as well as the mixing speed (150 rpm), while mass fraction of the catalyst (e.g. 1, or 3 %), molar ratio of the reactants (e.g. 20:1, or 30:1), and sampling time (e.g. 20, 40, or 60 min) varied throughout the experiments. Initial results showed that the highest effect on increase in conversion have mass fraction of the catalyst and the molar ratio of the reactants. When using conventional KOH as a catalyst in the synthesis of fatty acid 2-propyl (FA-2-PRE) and 2-octyl (FA-2-OCE) esters, increase in its mass fraction from 1 to 3 %, after 20 minutes, led to an increase in the reaction conversion from 16,9 to 51,3 % (FA-2-PRE), and from 10,1 to 55,3 % (FA-2-OCE).

72

- [1] M. A. Bashir et al., Fuel Process. Technol. 227 (2022) 107120.  
[2] H. Sanli et al., Energy Fuels. 22 (2008) 2713-2719.  
[3] S. K. Hoekman et al., Renew. Sust. Energ. Rev. 16 (2012) 143-169.

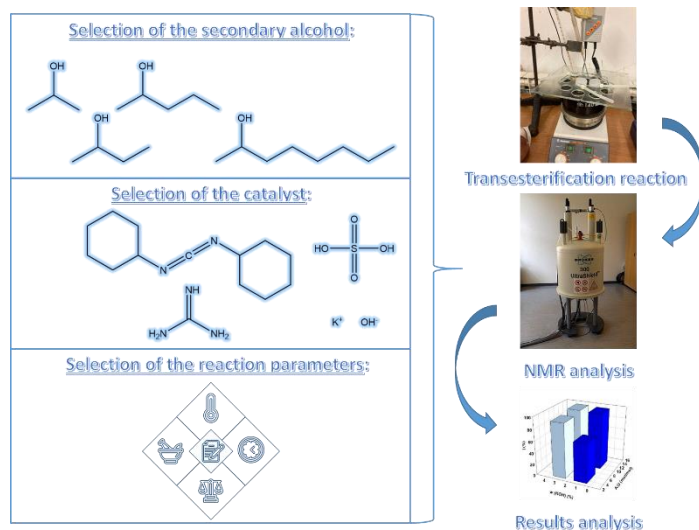

## LSTM NEURONSKE MREŽE – NAPREDNI AI ALAT ZA MODELIRANJE INDUSTRIJSKIH PROCESA

### LSTM NEURAL NETWORKS – ADVANCED AI TOOL FOR INDUSTRIAL PROCESS MODELLING

**Donna Danijela Dragun, Marina Bekavac, Marinela Jelačić, Srečko Herceg,  
Željka Ujević Andrijić, Nenad Bolf**

Sveučilište u Zagrebu Fakultet kemijskog inženjerstva i tehnologije, Trg Marka Marulića 19, 10000 Zagreb, Hrvatska  
ddragun@fkit.unizg.hr

LSTM (engl. *long short-term memory*) neuronske mreže vrsta su dinamičkih neuronskih mreža često korištenih kod izrade empirijskih modela sustava gdje je vremenski kontekst u slijednim podacima važan. Za razliku od tradicionalnih statičkih neuronskih mreža gdje se koriste trenutne vrijednosti ulaznih varijabli da bi se procijenila izlazna varijabla, kod dinamičkih neuronskih mreža koristi se niz prošlih vrijednosti ulaznih varijabli za procjenu izlaza. To je važno ako se radi o složenim sustavima s naglašenom dinamikom. Kod industrijskih procesa, primjena LSTM mreža je posebno zanimljiva kad je u pitanju procjena teško mjerljivih varijabli u složenim nelinearnim nestacionarnim industrijskim procesima. U rafinerijskom procesu izomerizacije ključno je mjeriti količinu komponenti u proizvodu procesa koja utječe na oktanski broj dobivenog motornog benzina. Procesni analizatori koji se uobičajeno za tu svrhu koriste su skupi i podložni kvarovima. Da bi se nastavilo kontinuirano željeno odvijanje procesa kad se dogodi kvar takvog analizatora primjenjuju se matematički modeli koji služe za procjenu količine ključnih komponenti u proizvodu procesa.

Ovaj rad prikazuje razvoj empirijskih modela za kontinuiranu procjenu količine 2,3-dimetilbutana (2,3-DMB) i 2-metilpentana (2-MP), kao ključnih komponenata u proizvodu rafinerijskog procesa izomerizacije upotrebom LSTM neuronskih mreža. Rad uključuje potrebne korake za razvoj empirijskih modela kao što su predobrada prikupljenih podataka i određivanje utjecajnih varijabli. Razvijeni modeli pokazali su prihvatljive statističke i grafičke rezultate te ih je moguće primijeniti na industrijskom postrojenju.

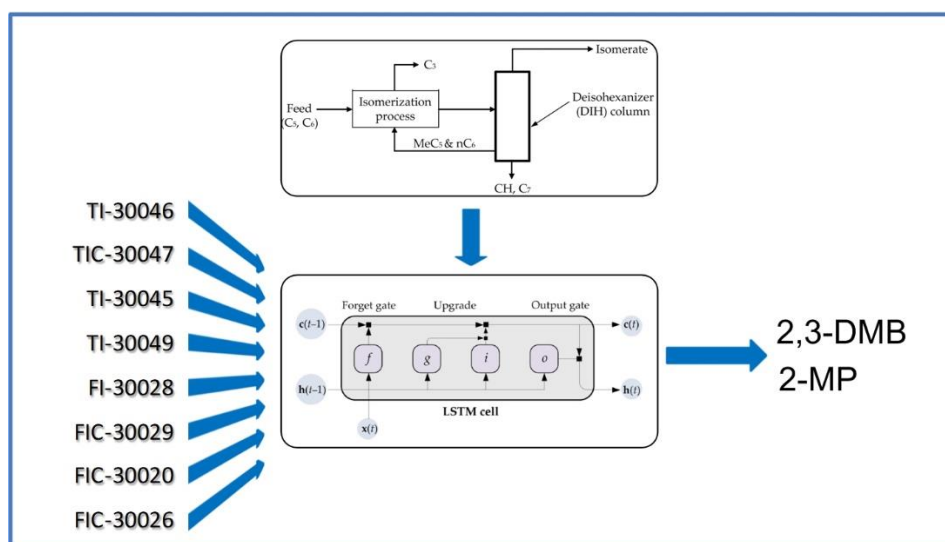

## METODE SEPARACIJE SMJESE ACETONITRIL-VODA

### METHODS OF SEPARATION OF AN ACETONITRILE-WATER MIXTURE

**Leonarda Frljak, Alegra Vezjak Fluksi, Ana Petračić, Aleksandra Sander**

Sveučilište u Zagrebu Fakultet kemijskog inženjerstva i tehnologije, Trg Marka Marulića 19, 10000 Zagreb, Hrvatska  
lfrljak@fkit.unizg.hr

Kako je acetonitril često korištena tvar u nizu proizvodnih procesa u različitim granama industrije česta je i komponenta otpadnih voda. Zbog visoke potražnje, ali i zbog njegovih toksičnih svojstava cilj ga je u što većoj mjeri izdvojiti iz nastalih otpadnih voda i vratiti u proces, čime se istovremeno i sprječava onečišćenje okoliša. Taj zadatak nije jednostavan obzirom da acetonitril s vodom tvori azeotrop niskog vrelišta.

Ovim su istraživanjem ispitane efikasnosti separacije smjese acetonitrila i vode destilacijom pri sniženom tlaku, ekstrakcijskom destilacijom i ekstrakcijom uzimajući atmosfersku destilaciju kao referentnu metodu. Destilacija je provedena pri tlakovima u intervalu od 0,25 do 0,75 bara, a najveće poboljšanje u čistoći destilata postignuto je pri tlaku od 0,25 bara pri čemu je udio acetonitrila u destilatu bio 87,9%. Ekstrakcijska destilacija provodila se uz dodatak 10, 15 i 22 % hidrofilnih niskotemperaturnih eutektičkih otapala. Dodatkom 22% otapala, destilacija uz glikolnu kiselinu:kolin klorid (3:1) rezultirala je maksimalnom čistoćom destilata od 87,5 %, a ona uz glikolnu kiselinu:tetrametilamonijev klorid (3:1) 83,8 % acetonitrila. Ekstrakcija je provedena uz primjenu hidrofobnih niskotemperaturnih eutektičkih otapala na bazi mentola pri različitim masenim omjerima otapala i pojne smjese (od 0,25 do 1,00 kg/kg). Prije provedbe ekstrakcije eksperimentalno su određene binodalne krivulje i vezne linije za odabrane sustave. Pri najvećem masenom omjeru otapala i pojne smjese maksimalna postignuta efikasnost ekstrakcije uz dekansku kiselinu:mentol (1:2) kao sekundarno otapalo iznosila je 48,6 %, a uz dodekansku kiselinu:mentol (1:2) 42,9 %. Na temelju dobivenih rezultata može se zaključiti da je najučinkovitija metoda separacije smjese acetonitrila i vode, destilacija pri sniženom tlaku.

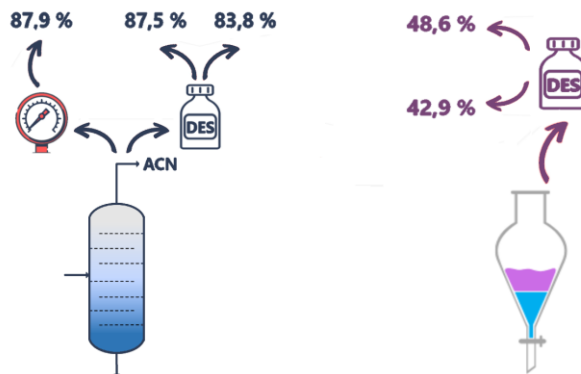

FOTOKATALITIČKA RAZGRADNJA NEONIKOTIONIDA  
POTPOMOGNUTO MAGNETSKIM POLJEM  
PHOTOCATALYTIC DEGRADATION OF NEONICOTHIONIDS  
ASSISTED BY A MAGNETIC FIELD

**Veronika Gorup, Maja Klasić, Vanja Kosar**

Sveučilište u Zagrebu Fakultet kemijskog inženjerstva i tehnologije, Trg Marka Marulića 19, 10000 Zagreb, Hrvatska  
mklasic@fkit.unizg.hr, vgorup@fkit.unizg.hr

Fotokataliza je kemijski proces u kojem se tvar razgrađuje ili raspada uslijed izlaganja svjetlu. Najčešći izvor zračenja je ultraljubičasto (UV) svjetlo koje daje potrebnu energiju za pobuđivanje elektrona u fotokatalizatoru. [1] Fotokatalitička razgradnja, zajedno s magnetskim poljem, može pridonijeti učinkovitosti razgradnje organskih zagađivača u vodi, sintezi organskih spojeva te uklanjanju zagađivača iz industrijskih otpadnih voda. [2] Prisutnost magnetskog polja ima potencijal poboljšati kretanje i putanju nabijenih čestica, uključujući elektrone i šupljine. Magnetsko polje se može na različite načine integrirati u fotokatalizu. Kada se primijeni magnetsko polje, nanočestice se koncentriraju na određenom mjestu unutar reakcijske smjese povećavajući lokalnu koncentraciju katalizatora. Zatim, magnetsko polje se može koristiti za stvaranje magnetskog miješanja, koje miješa reakcijsku smjesu osiguravajući da svi reaktanti dođu u kontakt s fotokatalizatorom. Također, nakon završetka fotokatalize magnetsko polje može se primijeniti za odvajanje magnetskog fotokatalizatora od reakcijske smjese. To može olakšati ponovnu upotrebu katalizatora i spriječiti onečišćenje proizvoda. [2,3] Neonikotinoidi su skupina insekticida koji se često koriste u poljoprivredi i domaćinstvima za uništavanje i odbijanje štetnih kukaca. Neonikotinoidi su sistemski insekticidi što znači da ih biljka upija, kroz korijenje ili površinu, nakon čega se šire u sve dijelove biljke ksilemskim transportom. Primjena neonikotinoida ima negativan utjecaj na oprašivače, posebno pčele kod kojih dolazi do poremećaja ponašanja i prikupljanja hrane, postaju dezorijentirane, manje aktivne. Zbog toga je danas većina neonikotinoda zabranjena. Cilj ovog rada je ispitati utjecaj magnetskog polja na fotokatalitičku razgradnju neonikotinoida. [2-4]

75

---

- [1] W. S. Koe et al., Environ Sci Pollut Res 27 (2020) 2522–2565
- [2] V. Kosar et al., Processes 11 (2023) 2588.
- [3] L. Xue et al., Chemosphere 3(2020) 126672.
- [4] D. Tassalit et al., Water Sci Technol. 74 (2016) 1953-1963.



Slika 1. Neodimijski magneti



## KOKRISTALIZACIJOM POTAKNUTA ADICIJA NIKOTINAMIDA NA KOORDINACIJSKI SPOJ $\text{Cu}(\text{nikotinamid})_2(\text{NCS})_2$

### COCRYSTALLIZATION-INDUCED ADDITION OF NICOTINAMIDE ONTO COORDINATION COMPOUND $\text{Cu}(\text{nicotinamide})_2(\text{NCS})_2$

**Mila Grgurić, Lidija Posavec, Dominik Cinčić**

Sveučilište u Zagrebu Prirodoslovno-matematički fakultet, Kemijski odsjek, Horvatovac 102a, 10000 Zagreb, Hrvatska  
mrguric.chem@pmf.hr

U ovome je istraživanju cilj bio ispitati mogućnost nastajanja kokristala metaloorganskog spoja [1] tipa  $\text{CuL}_2(\text{NCS})_2$  te ispitati akceptorski potencijal izotiocijanatne skupine u konkurenciji s karbonilnim kisikom i dušikom amino-skupine na periferiji liganda (L). Polazni kvadratno-planarni koordinacijski spoj bakra(II) s izotiocijanatnim i nikotinamidnim (nico) ligandima,  $\text{Cu}(\text{nico})_2(\text{NCS})_2$ , dobiven je sintezom iz otopine uz grijanje smjese reaktanata [2]. Također, isti spoj dobiven je i starenjem oktaedarskog spoja,  $\text{Cu}(\text{nico})_2(\text{MeOH})_2(\text{NCS})_2$ . Metodom mljevenja (LAG) polaznog spoja  $\text{Cu}(\text{nico})_2(\text{NCS})_2$  i odabranog donora halogenske veze, tetrafluor-1,4-dijodbenzenom (14tfib) u omjeru 1:1 dobivena je smjesa reaktanata. Prekristalizacijom nastale smjese neočekivano je dobiven kokristal  $[\text{Cu}(\text{nico})_4(\text{NCS})_2](14\text{tfib})$  koji je nastao kao rezultat raspada početnog koordinacijskog spoja i dodatne koordinacije nikotinamida na ion bakra tijekom kokristalizacije s donorom. Dobiveni kokristal također je uspješno pripremljen *one-pot* mehanokemijskom sintezom mljevenjem polaznog spoja  $\text{Cu}(\text{nico})_2(\text{NCS})_2$ , nico i 14tfib u omjeru 1:2:1. U bazi strukturnih podataka CSD [3] postoje podaci samo za spojeve tipa  $\text{CuL}_4(\text{NCS})_2$  koji sadrže *ortho*- ili *para*-supstituirane piridine kao ligande (L). Stoga je ispitana mogućnost sinteze metaloorganske građevne jedinice dobivene kokristalizacijom, heksakoordinirani spoj  $\text{Cu}(\text{nico})_4(\text{NCS})_2$ . Svi pokušaji sinteze, mljevenjem reaktanata ili metodom grijanja smjese reaktanata, nisu rezultirali željenim spojem. Difrakcijom rendgenskog zračenja na jediničnom kristalu određena je molekulska i kristalna struktura polaznih spojeva  $\text{Cu}(\text{nico})_2(\text{NCS})_2$  i  $\text{Cu}(\text{nico})_2(\text{MeOH})_2(\text{NCS})_2$  te kokristala  $[\text{Cu}(\text{nico})_4(\text{NCS})_2](14\text{tfib})$ . Strukturna analiza kokristala pokazala je da karbonilni kisik nema ulogu akceptora halogenske veze, već sudjeluje u povezivanju metaloorganskih jedinica u 2D mreže vodikovim vezama  $\text{N-H}\cdots\text{O}$ . Svaki izotiocijanatni ligand povezan je s jednim donorom 14tfib, pri čemu nastaju halogenske veze  $\text{I}\cdots\text{S}$  koje dodatno povezuju 2D mreže metaloorganskih jedinica.

76

- [1] V. Nemeč et al., CrystEngComm, 23 (2021) 3063-3083.  
[2] F.A. Mautner, P.V. Jantscher, R.C. Fischer et al., Transit. Met. Chem. 46 (2021) 191–200.  
[3] C. R. Groom, I. J. Bruno, M. P. Lightfoot and S. C. Ward, Acta Cryst. B72 (2016) 171-179.

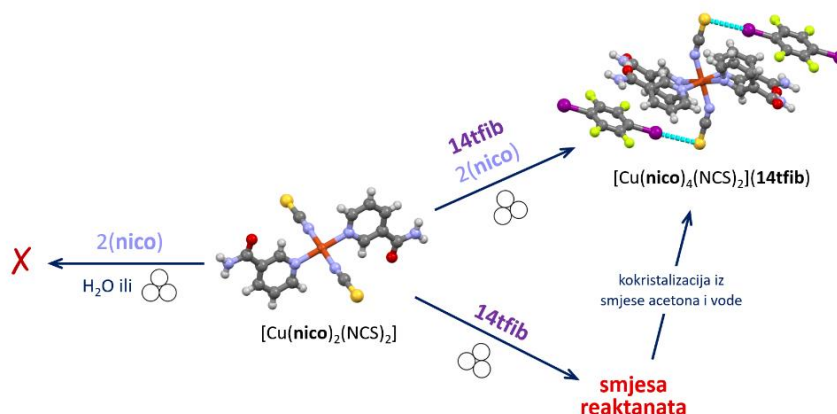

## SUSTAINABLE DRUG FORMULATION FOR MORE EFFICIENT HEALTHCARE

**Paola Grobenski, Melani Adamić-Golić, Paola Klonkay,  
Katarina Sokač, Krunoslav Žižek**

University of Zagreb Faculty of Chemical Engineering and Technology, Trg Marka Marulića 19, 10000 Zagreb,  
Croatia  
pgrobensk@fkit.unizg.hr

The pharmaceutical industry is facing numerous challenges nowadays, such as the use of toxic solvents, their disposal, and the synthesis of drugs, mainly suffering from poor solubility. Poor aqueous solubility results in a low and slow oral absorption of drug thus leading to low bioavailability and reduced pharmacotherapeutic efficacy of drug. Such drugs necessarily follow formulation stage in order to improve its properties. The objective of this specific study was to improve the properties of dasatinib (DAS), an anticancer drug suffering from poor solubility using solvent-free method following the principles of green chemistry.

Solid dispersions of DAS in a hydrophilic polyvinylpyrrolidone (PVP) were prepared mechanochemically in a planetary ball mill. The obtained dispersions were characterized using differential scanning calorimetry, X-ray powder diffraction, and Fourier-transform infrared spectroscopy. The results of the thermal analysis indicated an increase in the thermal stability and a notable reduction in the crystallinity of DAS in solid dispersions. X-ray diffraction confirmed these results and suggested a significant effect of the process variables on the crystallinity of DAS. Spectroscopic analysis did not reveal any potential interactions between drug and polymer. Provided analysis revealed optimal process conditions for successful mechanochemical preparation of DAS dispersions. Furthermore, excipients were granulated by melting in a fluidized bed. The tablets were prepared with: the initial drug, mechanochemically treated drug, solid dispersions, and physical mixtures of the drug and polymer.

Tablets were tested on mass uniformity, hardness, tablet disintegration, and the drug content in tablets. The release profiles of drug were determined by *in vitro* dissolution tests, indicating that mechanochemical treatment improves DAS release. Tablets containing a polymeric carrier showed a slower and controlled release of this specific drug, potentially achieving a continuous pharmacotherapeutic effect. Mechanochemical activation resulted in a drug with improved properties.

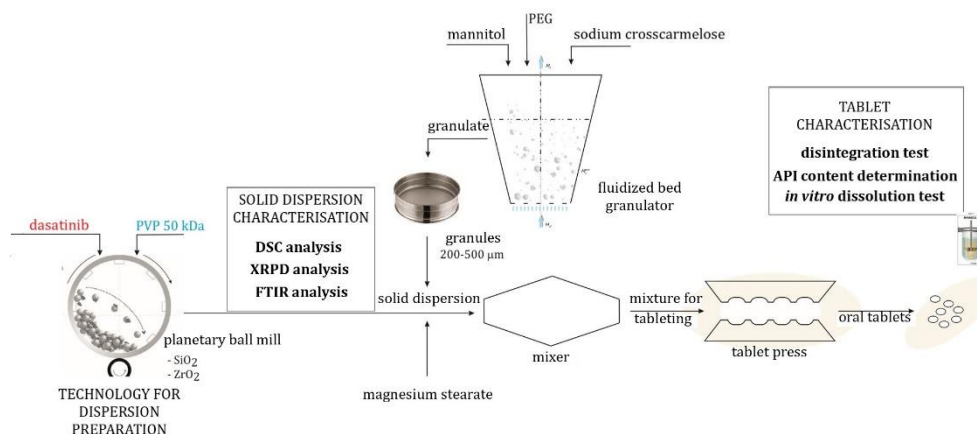

## OPTIMIZACIJA PROCESA PROIZVODNJE ELEKTRODA LI-IONSKIH BATERIJA

### OPTIMIZATION OF THE ELECTRODE PRODUCTION PROCESS OF LI-ION BATTERIES

**Tera Kardum, Sabina Fućak, Laura Jaklenec, Grgur Mihalinec, Zoran Mandić**

Sveučilište u Zagrebu Fakultet kemijskog inženjerstva i tehnologije, Trg Marka Marulića 19, 10000 Zagreb, Hrvatska  
tkardum@fkit.unizg.hr, sfucak@fkit.unizg.hr, ljaklenec@fkit.unizg.hr

Prekomjerno iskorištavanje fosilnih goriva seže još u doba industrijske revolucije što je ostavilo ekološke posljedice na današnjicu. Iz toga razloga, neophodan je razvoj održivih tehnologija temeljenih na obnovljivim izvorima energije. Kako se energija obnovljivih izvora stvara povremeno, stvorenu energiju je potrebno skladištiti što se najčešće provodi pomoću baterija. Među brojnim vrstama i kemizmima baterija, trenutno su najbolji odabir Li-ionske baterije. Prednost Li-ionskih baterija očituje se u visokom kapacitetu i učinkovitosti, vijeku trajanja do par tisuća ciklusa te niskoj cijeni. Proizvodni proces Li-ionskih baterija uvelike utječe na prethodno navedena svojstva stoga je nužno postaviti optimalne parametre proizvodnje kako bi se postigao maksimalni učinak. Među glavne proizvodne parametre ubrajaju se viskoznost elektrodne paste, debljina nanesenog elektrodnog filma te pritisak na elektrodu. Kontrolom vrijednosti ovih parametara utječe se na elektrokemijska svojstva Li-ionskog sustava stoga je moguće optimizirati proces prema vrijednostima elektrokemijskih testiranja. U ovome radu, optimizirani su spomenuti parametri na primjeru najkorištenije Li-ionske katode NMC 8:1:1.

Testiranje Li-ionskih sustava ispitano je standardnim tehnikama poput cikličke voltametrije, kronopotencimetrije i elektrokemijske impedancijske spektroskopije.

Ovaj rad financiran je od strane NATO organizacije projektom NATO SPS G5910- High Energy Calcium - Oxygen Batteries.

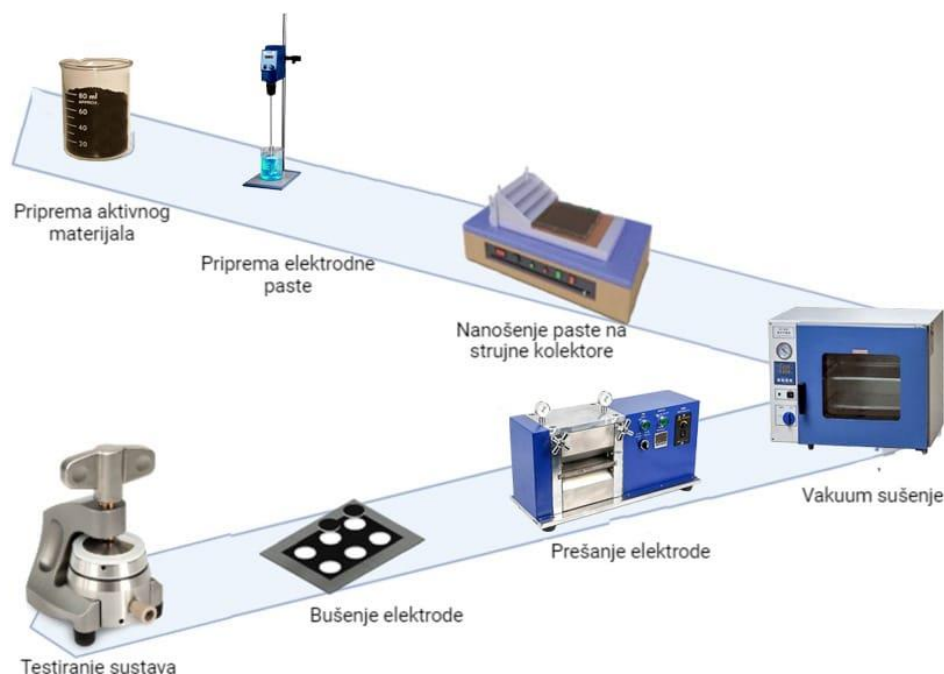

## PRIPRAVA, KARAKTERIZACIJA I UTJECAJ NISKOTEMPERATURNIH EUTEKTIČKIH OTAPALA NA DOZIRANJE DJELATNE TVARI

### PREPARATION AND CHARACTERIZATION OF DEEP EUTECTIC SOLVENTS, AND ITS INFLUENCE ON THE DOSING OF THE ACTIVE PHARMACEUTICAL INGREDIENT

**Lara Krmelić, Iva Zokić, Jasna Prlić Kardum**

<sup>1</sup>Sveučilište u Zagrebu Fakultet kemijskog inženjerstva i tehnologije, Trg Marka Marulića 19, 10000 Zagreb, Hrvatska  
lkrmelic@fkit.unizg.hr

Jedan od glavnih problema u farmaceutskoj industriji je slaba topljivost lijekova u vodi, što u ljudskom organizmu dovodi do niske bioraspoloživosti. Oko 40 % trenutno dostupnih lijekova i 90 % lijekova u razvoju sadrži djelatne tvari koje su slabo topive u vodi. Stoga su načini pronalaska poboljšanja topljivosti djelatne tvari od izuzetne važnosti za farmaceutsku industriju.[1]

Niskotemperaturna eutektička otapala (engl. Deep eutectic solvents, DES) koja sadrže ili djeluju kao otapala djelatnih tvari (API-DES) pojavila su se kao obećavajuća alternativa u pripremi novih formi koje poboljšavaju terapijsku učinkovitost lijekova.[2] Prednosti ovakvih sustava su netoksičnost, dobra mogućnost biorazgradljivosti, niska cijena te njihova relativno laka priprema i mogućnost podešavanja profila oslobađanja djelatne tvari.

U laboratoriju je pripremljeno i karakterizirano šest DES-ova koji se sastoje od akceptora vodikove veze, odnosno kolin klorida te prirodnih kiselina koje su donori vodikove veze (tartarna, jabučna, oleinska, glikolna, limunska i askorbinska kiselina). Kako bi se poboljšala topljivost djelatne tvari te omogućilo dobro miješanje, u viskozne i guste DES-ove dodano je 10 ili 20 mas % vode. Svim pripremljenim DES-ovima određena je gustoća, viskoznost i kiselost pri 37 °C. Nastanak DES-ova potvrđen je diferencijalnom pretražnom kalorimetrijom (DSC analizom) te je u njima određena maksimalna topljivost ceritiniba, djelatne tvari za liječenje raka pluća nemalih stanica.

- [1] S. Kalepu et. al., Acta Pharm. Sin. B. 5 (2015) 442–453.  
[2] E. L. Smith et. al., Chem. Rev. 114 (2014), 11060–11082.

## SYNTHESIS AND EVALUATION OF METHACRYLIC POLYMERS BASED ON 2-HYDROXYPROPYL METHACRYLATE AS POUR POINT DEPRESSANTS FOR DIESEL FUEL

**Fran Lindić, Tea Belačić, Katarina Barilar, Ivan Pucko, Fabio Faraguna**

University of Zagreb Faculty of Chemical Engineering and Technology, Trg Marka Marulića 19, 10000 Zagreb,  
Croatia  
flindic@fkit.unizg.hr

The application properties of diesel fuel need comply with the diesel standard EN 590 [1]. For this purpose, various additives are added to the diesel to ensure that all properties are within the values specified in the standard. As the standards become more demanding over the decades, it is necessary to work on the further development of new additives for this purpose. The additives used to improve the properties are mainly binary or ternary copolymers [2]. In our research, we have synthesized polymer additives to improve the application properties of non-additive diesel fuel. The additives were synthesized by free radical polymerization with various methacrylate monomers such as lauryl methacrylate, stearyl methacrylate, methyl methacrylate and 2-hydroxypropyl methacrylate. The purity and composition of the synthesized additives were determined by proton magnetic resonance analysis ( $^1\text{H}$  NMR) and the average molecular mass and dispersity by gel permeation chromatography (GPC). The thermal properties of the additives and their formulations with diesel fuel were determined by differential scanning calorimetry (DSC). To determine the influence of the additive addition on the properties of the diesel fuel, the density of the formulations was measured according to ASTM D4052 and the kinematic viscosity according to ASTM D445. We also determined the low-temperature properties, the cloud point (CP) according to ASTM D5771 and the pour point (PP) according to ASTM D5950. The density and viscosity values of the formulated fuel were in the range of the standard values and it was found that the additives improved the low-temperature properties such as the PP by more than 20 °C.

- [1] EN 590:2022; Automotive fuels – diesel - requirements and test methods. European Committee for Standardization: Brussels, Belgium, 2022.
- [2] I. Pucko et al. Fuel. 324 (2022) 124821. <https://doi.org/10.1016/j.fuel.2022.124821>.

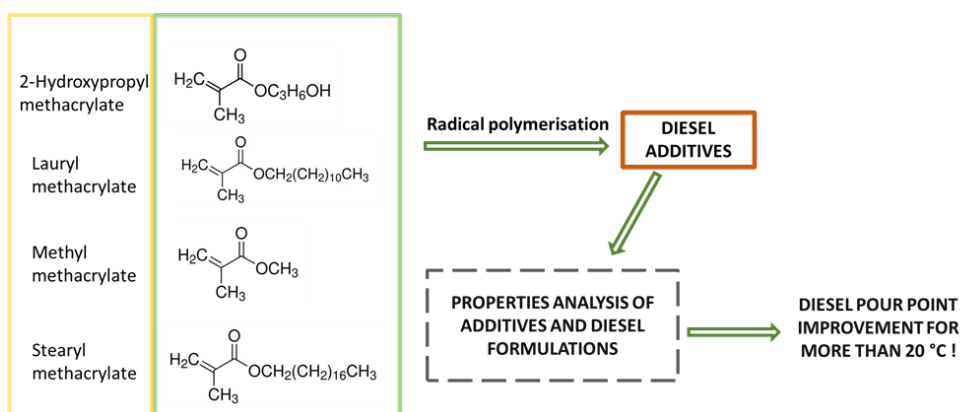

## PRIMJENA CHRISTIANSENOVE IZVEDBE KOLONE S RAZDJELNOM STIJENKOM ZA SEPARACIJU VIŠEKOMPONENTNIH SUSTAVA

### APPLICATION OF CHRISTIANSEN DIVIDING-WALL COLUMN CONFIGURATION FOR MULTICOMPONENT SYSTEM SEPARATION

**Goran Lukač, Ivan Bilmez, Igor Dejanović**

Sveučilište u Zagrebu Fakultet kemijskog inženjerstva i tehnologije, Trg Marka Marulića 19, 10000 Zagreb, Hrvatska  
glukac@fkit.unizg.hr

Primjena kolone s razdjelnom stijenkom (KRS) u procesnoj industriji značajan je korak naprijed prema održivosti i smanjivanju ukupnih emisija CO<sub>2</sub>, kojima ona značajno doprinosi. Zasada se primjena KRS u najvećoj mjeri svodi na izvedbe za tri proizvoda, s tek nekoliko izvedbi za četiri proizvoda u tzv. Kaibelovoj izvedbi, sa samo jednom razdjelnom stijenkom. Iako je to prednost s aspekta primjene, njezina jednostavna struktura ipak donosi i određena ograničenja – smanjeni broj stupnjeva slobode za upravljanje. To se naročito odnosi na glavni frakcionator, čiji središnji dio između dvaju bočnih proizvoda mora raditi u načinu totalnog pretoka. U praksi je to problematično održavati, naročito uslijed procesnih poremećaja, pa često dolazi do degradacije kvalitete dvaju srednjih proizvoda.

Kao moguće rješenje ovog operativnog problema nameće se korištenje horizontalne stijenke između dva bočna proizvoda te korištenje izmjenjivača topline kako bi obje novonastale sekcije glavnog frakcionatora i dalje bile toplinski povezane. Ovakvu konfiguraciju, koja se u literaturi označava i kao „|- kolona“, prvi je predložio Atle C. Christiansen [1]. Ona u potpunosti sprječava mogućnost pojave ponovnog miješanja dviju srednjih komponenti te omogućuje dodatno dovođenje ili odvođenje toplinske energije, što u teoriji omogućuje fleksibilniji rad kolone, odnosno tzv. *decoupling* dvije sekcije.

U ovom radu, uspoređeni su stacionarni simulacijski rezultati obje izvedbe kolone dobiveni detaljnim modelima destilacije. Kao primjer separacije, korištena je višekomponentna smjesa ugljikovodika s 15 različitih komponenti koja se oštro separira na četiri proizvoda.

[1] A. C. Christiansen et al., *Comput. Chem. Eng.* (1997) 21.

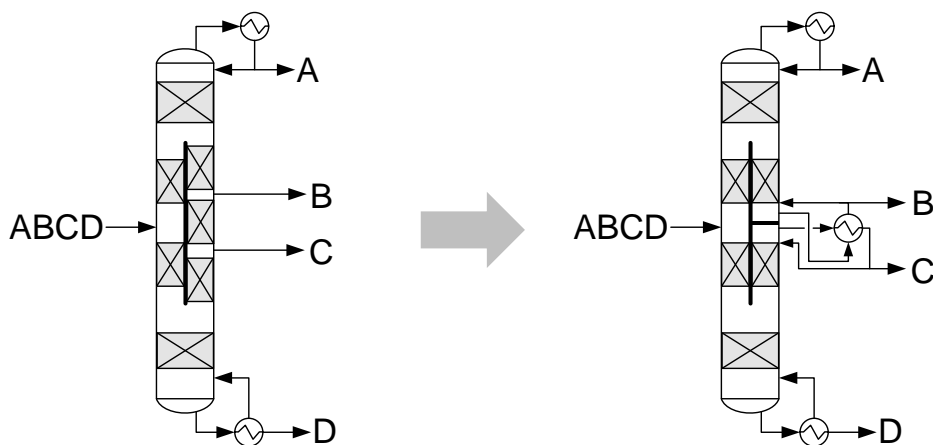

## MECHANOCHEMICAL Pt/Y CATALYST FOR HYDRODEOXYGENATION OF BIOMASS-DERIVED OXYGENATED COMPOUNDS

**Mariana Matos<sup>1</sup>, Nelson Nunes<sup>1,2</sup>, Ana Paula Carvalho<sup>2,3</sup>, José Coelho<sup>1,4</sup>,  
Angela Martins<sup>1,2</sup>**

<sup>1</sup>DEQ, Instituto Superior de Engenharia de Lisboa, Instituto Politécnico de Lisboa, Lisboa, Portugal

<sup>2</sup>Centro de Química Estrutural, Faculdade de Ciências, Institute of Molecular Sciences, Universidade de Lisboa, Lisboa, Portugal

<sup>3</sup>Departamento de Química e Bioquímica, Faculdade de Ciências da Universidade de Lisboa, Lisboa, Portugal.

<sup>4</sup>Centro de Química Estrutural, Instituto Superior Técnico, Institute of Molecular Sciences, Universidade de Lisboa, Lisboa, Portugal.

mariana.matos@isel.pt

Hydrodeoxygenation (HDO) reaction aims to transform biomass-derived oxygenated compounds into hydrocarbons, free of oxygen, with suitable properties to integrate fuels. Catalytic HDO is carried out in the presence of bifunctional (metal + acid) catalysts, with metal loaded zeolites being among the most studied catalysts [1]. The metal function can be introduced in zeolite matrices by several methods like ion exchange, incipient wetness impregnation or mechanical mixture. The latter method brings the advantage of being solvent-free with suppression of solvent elimination and material drying steps. On the other hand, the use of ball-mill equipment with accurate control of the mixing parameters: time, frequency, number and size of balls inside the jar, causes modification on the size and shape of zeolite crystals and also can induce modification on the metal precursor, producing bifunctional catalysts with optimized properties [2]. In this study, bifunctional Pt/Y (1 wt.% Pt) was produced by mixing commercial HY zeolite (Zeolyst, SiO<sub>2</sub>/Al<sub>2</sub>O<sub>3</sub>=5.4) with Pt(NH<sub>3</sub>)<sub>4</sub>Cl<sub>2</sub>·xH<sub>2</sub>O in a planetary ball-mill (Resch, planetary type with agate vase with 5 spheres), changing time (15 or 30 min) and frequency (200 or 400 rpm). The materials were calcined in a muffle at 550 °C and reduced with H<sub>2</sub> at 450 °C, when needed. Upon characterization through powder XRD, N<sub>2</sub> adsorption at -196 °C and laser diffraction particle sizing (LDS), the catalytic performance was evaluated in HDO reaction using guaiacol as model molecule in Parr 4843 batch reactor, with 200 mg of catalysts and 25 mL of 5 vol. % of guaiacol in *n*-heptane, at 250 °C, 20 atm and 350 rpm. Samples were withdrawn periodically, and the reaction products were analysed by gas chromatography equipped with FID detector and DB5-MS capillary column.

82

[1] S. Kim et al., Green Chem. 21 (2019) 3715.

[2] G. Majano et al., Micropor. Mesopor. Mater. 194 (2014) 106–114.

This research was funded by Fundação para a Ciência e Tecnologia (FCT) through UIDB/00100/2020, UIDP/00100/2020 and LA/P/0056/2020 and IPL through Project IPL/2023/Zeo@BioRef ISEL.

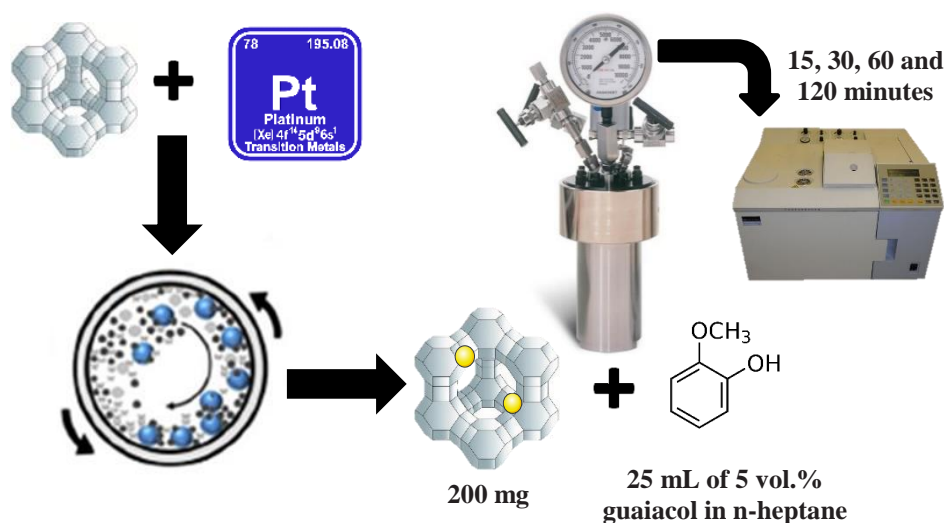

# ELEMENTNA ANALIZA KOŠTICA BADEMA (*Prunus amygdalus*) I MARELICE (*Prunus armeniaca*) METODOM SPEKTROMETRIJE MASA UZ INDUKTIVNO SPREGNUTU PLAZMU

## ELEMENTAL ANALYSIS OF THE ALMOND (*Prunus amygdalus*) AND APRICOT KERNEL (*Prunus armeniaca*) BY INDUCTIVELY COUPLED PLASMA MASS SPECTROMETRY

**Katarina Puklavec<sup>1</sup>, Iva Juranović Cindrić<sup>1</sup>, Ivan Nemet<sup>1</sup>, Michaela Zeiner<sup>2</sup>,  
Heidelore Fiedler<sup>2</sup>**

<sup>1</sup>Sveučilište u Zagrebu Prirodoslovno-matematički fakultet, Kemijski odsjek, Zavod za analitičku kemiju, Horvatovac 102a, 10000 Zagreb, Hrvatska

<sup>2</sup>Örebro University, School of Science and Technology, Man-Technology-Environment Research Centre, 5 Fakultetsgatan 1, Örebro, Sweden  
kpuklavec.chem@pmf.hr

Koštice badema (*Prunus amygdalus*) i marelice (*Prunus armeniaca*) su plodovi bogate nutritivne vrijednosti i izuzetne dobrobiti za ljudski organizam te kao takvi važan dio zdrave i raznolike prehrane. Osim esencijalnih masnih kiselina te antioksidansa, sadrže i važne minerale neophodne za neometanu funkciju staničnih procesa. Istraživanja su pokazala da bademi pridonose smanjenju kolesterola i rizika od kardiovaskularnih bolesti [2], a osim toga vrlo važnu ulogu imaju u prehrambenoj i kozmetičkoj industriji. Koštice marelice se u obliku ulja, osim u prethodno navedenim industrijama, koriste i u medicini radi svojih antifungalnih i antibakterijskih svojstava [3]. Budući da koštice marelice sadrže veliku količinu amigdalina, poznatijeg i kao vitamin B17, koji hidrolizom prelazi u cijanovodičnu kiselinu, konzumacija veće količine ovih plodova može biti opasna po zdravlje [4]. Usitnjeni i osušeni uzorci koštica badema i marelice podvrgnuti su multielementnoj analizi metodom spektrometrije masa uz induktivno spregnutu plazmu (ICP-MS) nakon pripreve uzorka mikrovalno potpomognutom razgradnjom. U analiziranim uzorcima u najvećem udjelu prisutni su K, Mg i Ca, a manje zastupljeni Fe, Zn i Mn. Potencijalno toksični elementi nisu pronađeni u udjelima opasnim za zdravlje.

83

- [1] N. P. Kalogiouri et al., Sep. 8, 28 (2021)  
[2] S. Li et al., Sci. Food Agric. 96(10) (2016) 3351-3357.  
[3] D. Čolić et al., Sci. Hortic. 275 (2021) 109-705.  
[4] D. Cigolini et al., Emerg. Med. J. 28.9 (2011) 804-805.

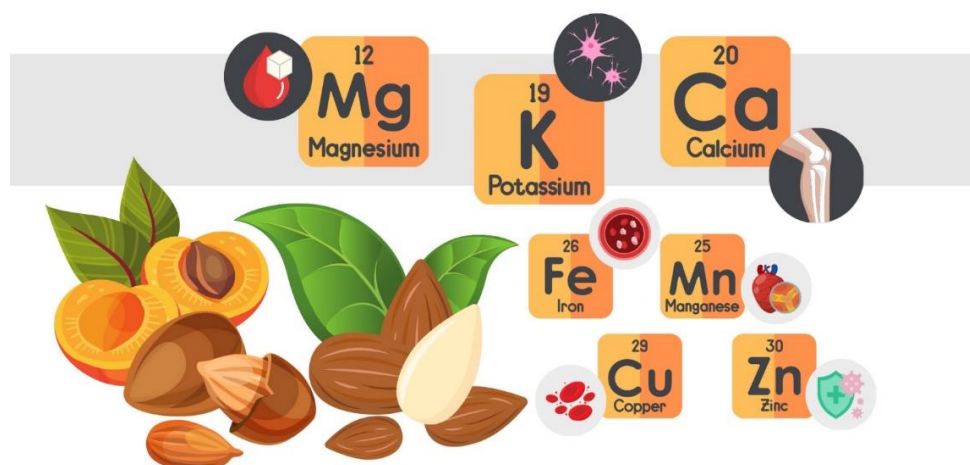



## SOFTVERSKI SENZOR ZA KONTINUIRANU PROCJENU SADRŽAJA PROPENA

### SOFT SENSOR FOR CONTINUOUS ESTIMATION OF PROPENE CONTENT

**Nikola Rimac, Ines Martić, Željka Ujević Andrijić**

Sveučilište u Zagrebu Fakultet kemijskog inženjerstva i tehnologije, 10000 Zagreb, Hrvatska  
nrimac@fkit.unizg.hr

U ovom istraživanju opisan je razvoj softverskih senzora namijenjenih kontinuiranom monitoriranju sadržaja propena u rafinerijskom postrojenju propan/propen splitter. Podaci ulaznih varijabli modela usklađeni su vremenski s izlaznom varijablom te su podvrgnuti različitim metodama predobrade podataka. Korištenjem programskog jezika Python, izrađeni su modeli softverskih senzora temeljeni na neuronskim mrežama s višeslojnim perceptronom (MLP) i neuronskim mrežama s dugotrajnim kratkoročnim pamćenjem (LSTM).

U fazi razvoja MLP modela, istraženi su hiperparametri mreže poput broja neurona u skrivenom sloju i utjecaja različitih prijenosnih funkcija na kvalitetu razvijenih neuronskih mreža. Za LSTM modele, dodatno je analiziran broj vremenskih koraka u prošlost i broj LSTM jedinica. Oba modela pokazala su visoke i slične vrijednosti koeficijentata korelacije te niske pogreške u usporedbi sa stvarnim podacima iz postrojenja, što potvrđuje njihovu pouzdanost za primjenu u rafinerijskom informacijskom sustavu.

Primjena softverskih senzora donosi smanjenje potrebe za skupim mjernim analizatorima i opremom koja je podložna čestim kvarovima, omogućujući potencijalnu potpunu zamjenu postojećih procesnih analizatora. Osim toga, primjena softverskih senzora na postrojenju unaprijedit će automatsko vođenje procesa, što će rezultirati stabilnijim tijekom rafinerijskog procesa i poboljšanom kvalitetom konačnog produkta. Analiza trendova i histograma pogreške razvijenih modela dodatno potvrđuje visoku kvalitetu njihove izvedbe.

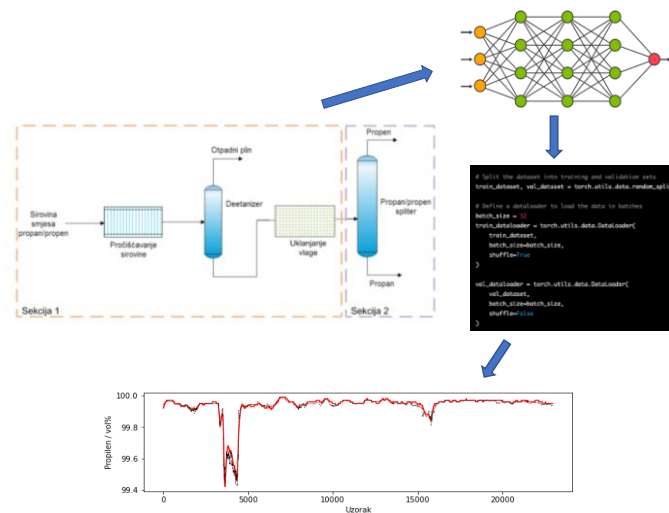

## ODABIR SUSTAVA I PROCESNIH UVJETA ZA PROVEDBU SFERIČNE KRISTALIZACIJE CERITINIBA

### SELECTION OF SOLVENT SYSTEMS AND PROCESS CONDITIONS FOR CERITINIB SPHERICAL CRYSTALLIZATION

**Mirta Sabol, Lana Crnac, Juraj Vuić, Martina Ćurić, Ivan Vučić, Iva Zokić, Jasna Prlić Kardum**

Sveučilište u Zagrebu Fakultet kemijskog inženjerstva i tehnologije, Trg Marka Marulića 19, 10000 Zagreb, Hrvatska  
msabol@fkit.unizg.hr

Sferična kristalizacija inovativna je metoda razvijena s ciljem unaprjeđenja procesa koji slijede nakon kristalizacije. Metoda omogućuje izravno stvaranje sferičnih kristala djelatne tvari, što rezultira smanjenjem broja koraka u daljnjoj formulaciji lijeka. Rezultat sferične kristalizacije su čestice većih dimenzija i uske raspodjele veličina čestica. Procesni parametri kojima se može utjecati na svojstva dobivenih kristala su: sustav otapala, vrsta i količina aditiva, vrsta i brzina vrtnje miješala te temperatura pri kojoj se provodi proces [1, 2]. U ovom radu su ispitani utjecaji sustava otapala, aditiva, vrste i brzine vrtnje miješala prilikom provedbe sferične kristalizacije ceritiniba, djelatne tvari koja se koristi u svrhu liječenja raka pluća. Provedene su tri metode sferične kristalizacije: sferična aglomeracija, kvazi – emulzijska difuzija otapala i kombinacija navedenih metoda. Iz eksperimentalnih je rezultata vidljivo da su kristali dobiveni metodom kvazi-emulzijske difuzije otapala veći od onih dobivenih sferičnom aglomeracijom. Također, povećanjem udjela polivinilpirolidona u vodi dolazi do nastanka manje količine sferičnih kristala većih dimenzija. Mikrografije kristala ukazuju na to da su najpravilnije sfere dobivene kombinacijom tehnika uz tetrahidrofuran kao otapalo, vodu kao antiotapalo, heptan kao kapljevinu za premoštenje te uz dodatak 1%w/w polivinilpirolidona. Preliminarnim ispitivanjem utjecaja vrste i brzine vrtnje miješala utvrđeno je da je najuža raspodjela veličina čestica dobivena primjenom spiralnog propelerskog miješala koje uzrokuje miješani tok u reaktoru. Daljnja optimizacija i određivanje procesnih uvjeta provodi se pomoću programa *Design Expert*, s ciljem uvećanja procesa šaržne sferične kristalizacije.

85

- [1] M. Maghsoodi, Adv. Pharm. Bull. 2 (2012) 253–257.  
[2] S. K. Putta et al., J. Chem. Pharm. Res. 8 (2016) 611-623.

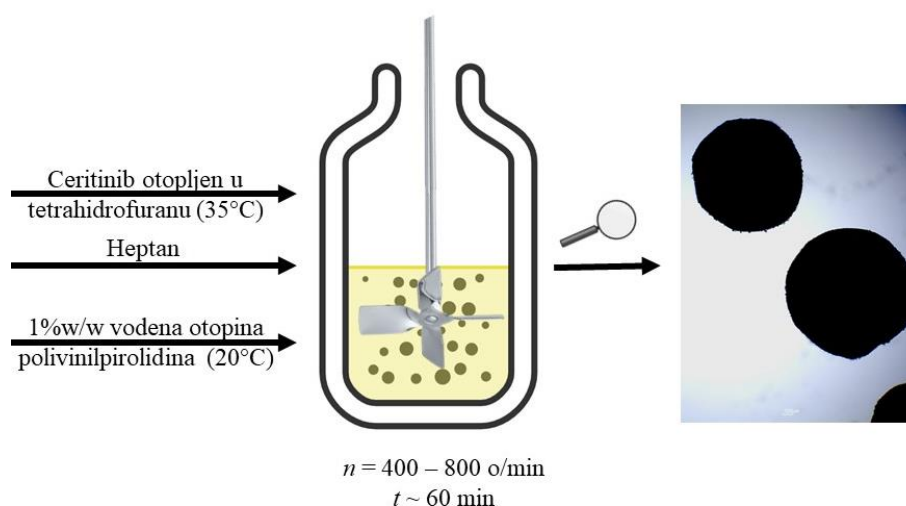

## DESIGN OF A LAB-SCALED SYSTEM FOR HYDROGEN PRODUCTION BASED ON PEM WATER ELECTROLYSIS

**Marko Sejdić<sup>1</sup>, Srećko Herceg<sup>1</sup>, Nenad Bolf<sup>1</sup>, Danijel Krznar<sup>2</sup>**

<sup>1</sup>University of Zagreb Faculty of Chemical Engineering and Technology, Department of Measurements and Process Control, Savska cesta 16/5a, 10 000 Zagreb, Croatia

<sup>2</sup>Automation Design Solutions ltd., Vladka Mačeka 5, 10 430 Samobor, Croatia  
msejdic@fkit.unizg.hr

The current state of affairs concerning climate change and the target of achieving decarbonization by 2050, along with the rise in fossil fuel prices, has notably influenced the surge in demand for clean and sustainable energy sources. Green hydrogen emerges as a promising alternative to fossil fuels and holds substantial potential in combating climate change. Its primary production method involves electrolysis of water, utilizing electricity sourced from renewable energy. Two prevalent technologies for this process are alkaline electrolysis (AE) and proton-exchange membrane (PEM). AE often encounters inefficiencies due to fouling deposit formation on electrocatalysts, making it unsuitable for large-scale hydrogen production. In contrast, PEM electrolysis incorporates a proton exchange membrane, selectively allowing protons to pass while hindering electron passage. Recognized as a clean and efficient method, PEM electrolysis has garnered attention for hydrogen production, heralded as a clean fuel. The hydrogen generated through this method finds applications in fuel cells for vehicles and industrial processes. This technologies allure lies in its capacity to function at relatively low temperatures and pressures, rendering it more energy-efficient compared to alternative electrolysis methods.

In our laboratory, we have developed and tested a laboratory scaled PEM water electrolysis system. We employed pulse-width modulation (PWM) to modulate the signal from the DC power source for achieving optimal conditions for maximum hydrogen production by adjusting signal width, frequency, and other operational parameters. Through the integration of PEM electrolysis and PWM, we plan to achieve significant increase in hydrogen production efficiency.

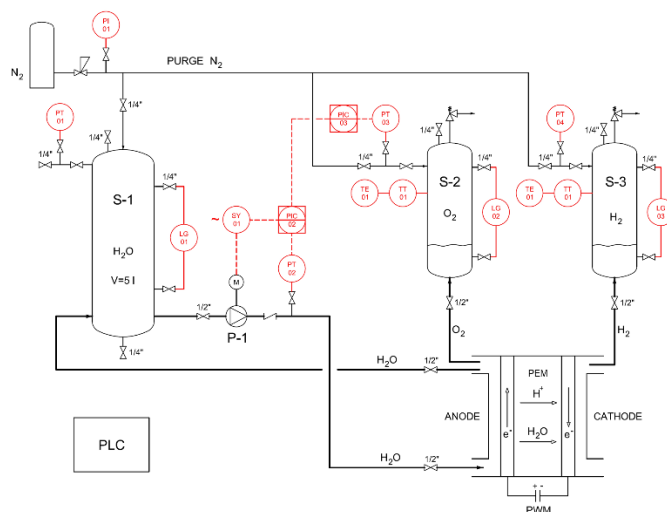

## THE INFLUENCE OF THE CRYSTALLIZATION PARAMETERS ON PHYSICAL PROPERTIES AND DISSOLUTION OF AN ACTIVE PHARMACEUTICAL INGREDIENT

**Valentina Travančić, Dijana Škalec Šamec**

Teva API R&D, Prilaz baruna Filipovića 25, 10000 Zagreb, Croatia  
Valentina.travancic@pliva.com

In this work, the influence of the crystallization process on production on a bigger scale and also dissolution has been studied. Crystallization process is one of the most important processes in the pharmaceutical company. This process is highly used to obtain the final product in the final step and it is very important to find the proper parameters to obtain material with define purity and quality. Beside polymorphism and purity, morphology and defined particle size distribution are critical parameters of the final product. Morphology and particle size distribution are affecting processes like filtration, drying, formulation process and most important dissolution. This work shows the feasibility study with different crystallization processes and impact to the physical properties. It has been shown the difference between cooling and antisolvent crystallization and using different parameters such as linear and cubic cooling profile with different speed to obtain total suspension.

Four different materials are obtained and tested: material with small particles with defined morphology and narrow distribution, small particles with undefined morphology and broad distribution, big particles with defined morphology and narrow distribution and big particles with undefined morphology and broad distribution.

Properties like filtration flux, drying profile, packaging density and dissolution test are performed on materials obtained by different crystallization processes. Material with small particles and narrow distribution has the best properties in comparison to the other materials and it has been shown the impact of the defining proper morphology and desired uniform particle size distribution on the production processes and dissolution.

- [1] B.Yu. Shekunov, P. York, J. Cryst. Growth 211 (2000) 122-136.
- [2] K. Madane, V. Ranade, Chem. Eng. J. 446 (2022) 137235.
- [3] Z. Q. Yu et al., Chem. Eng. Res. Des. 85 (2007) 893-905.

## FATTY ACID PROPYL ESTER-BASED BIODIESEL: LIQUID-LIQUID EQUILIBRIUM STUDY IN PSEUDOTERNARY SYSTEMS

**Nikola Turčić, Kristina Zagajski Kučan, Marko Rogošić**

University of Zagreb Faculty of Chemical Engineering and Technology, Trg Marka Marulića 19, 10000 Zagreb, Croatia  
nturcic@fkit.unizg.hr

Biodiesel is a renewable, non-toxic and biodegradable fuel produced from waste vegetable oil, grease and animal fat. Its higher cetane number, lower sulphur content, lesser greenhouse gasses and diesel particulate matter emissions makes it a suitable replacement for petroleum diesel as engine fuel. Biodiesel is commonly synthesized by transesterification, a reaction where oil/fat reacts with alcohol in the presence of a catalyst (KOH) to form fatty acid esters (biodiesel) and glycerol. The final product of this reaction is a two-phase, pseudoternary mixture composed of a glycerol rich phase and a biodiesel rich phase. Knowing of liquid-liquid equilibria in biodiesel systems is important in biodiesel purification processes on an industrial scale. In this work, liquid-liquid equilibria in pseudobinary and pseudoternary systems consisting of glycerol, propanol, water and biodiesel (fatty acid propyl ester, FAPRE) were experimentally determined at 25 °C and atmospheric pressure. Additionally, a calibration curve for the two-component system water-glycerol was determined using refractometry. The miscibility of water with propanol and glycerol and its immiscibility with FAPRE makes it a promising solvent for extractive purification of biodiesel.

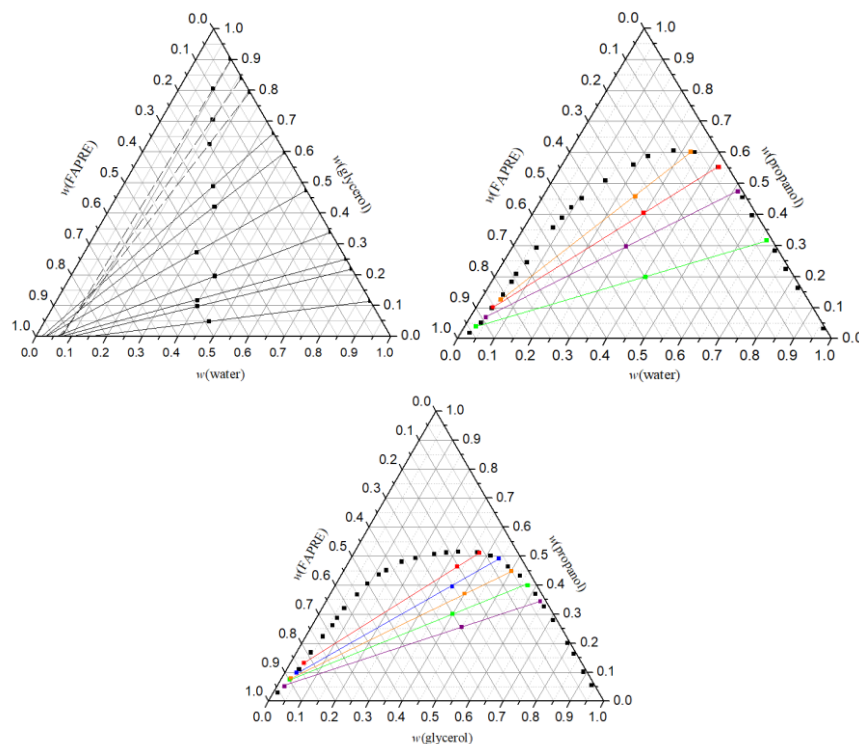

## PRISILNA RAZGRADNJA ATAZANAVIRA FORCED DEGRADATION STUDY OF ATAZANAVIR

**Luka Večenaj, Viktorija Martinjak, Kristina Bule Možar, Martina Miloloža,  
Lidija Furač, Marinko Markić, Dajana Kučić Grgić, Matija Cvetnić,  
Tomislav Bolanča, Šime Ukić**

Sveučilište u Zagrebu Fakultet kemijskog inženjerstva i tehnologije, Trg Marka Marulića 19, 10000 Zagreb, Hrvatska  
lvecenaj@fkit.unizg.hr

Atazanavir je bijeli prah slabo topljiv u vodi koji se inicijalno koristio u kombinaciji s drugim antivirusnim lijekovima u liječenju zaraženih virusom HIV-a. Tijekom COVID-19 pandemije počinje se koristiti u liječenju zaraženih SARS-CoV-2 virusom čime dolazi do intenziviranja njegove upotrebe, a samim time i povećanja količina atazanavira koje dospjevaju u okoliš [1]. U ovom radu provedena je studija prisilne razgradnje atazanavira ne bi li se naslutila njegova sudbina u okolišu, konkretno u vodenom mediju [2,3].

S ciljem praćenja koncentracije atazanavira u vodenom mediju, razvijena je i validirana HPLC metoda. Razvijena metoda pokazala je visoku linearnost s koeficijentom determinacije većim od 0,99, prihvatljivu razinu točnosti s analitičkim povratom u intervalu 70-130 % te preciznost s relativnom standardnom devijacijom manjom od 2 %.

Testovi prisilne razgradnje uključivali su hidrolizu pri kiselim (1 M HCl) i lužnatim uvjetima (1 M NaOH), oksidaciju s H<sub>2</sub>O<sub>2</sub>, te termičku i fotolitičku razgradnju. Testovima prisilne razgradnje utvrđena je stabilnost spoja pri većini ispitnih uvjeta što ukazuje na potencijal atazanavira da bude veoma postojan u vodenom okolišu te njegovu malu sklonost jednostavnim procesima razgradnje. Takva postojanost atazanavira potencira opasnost njegove prisutnosti u okolišu kao i potrebu za detaljnim istraživanjima ekotoksikološkog učinka te postupaka njegovog uklanjanja iz okoliša.

- [1] O. A. Chaves et al., *Pharmaceuticals* 15 (2022) 21.
- [2] S. Dey et al., *J. Pharm. Anal.* 7 (2017) 134-140.
- [3] C. H. Bhirud, S. N. Hiremath, *Drug Invent. Today* 5 (2013) 81-86.

Ovo istraživanje provedeno je u sklopu projekta Okolišni aspekti SARS-CoV-2 antivirusa (EnA-SARS, IP-2022-10-2822) financiranog od strane Hrvatske zaklade za znanost.

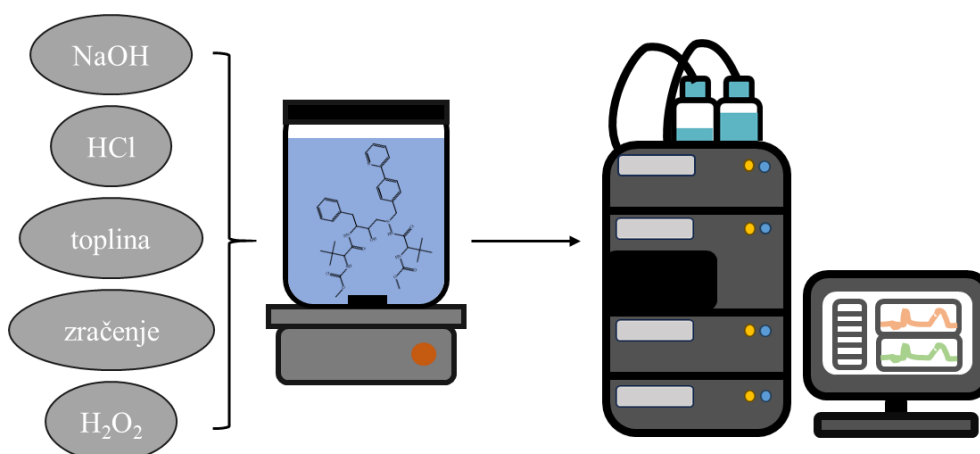

## MODELIRANJE TOPLJIVOSTI FLAVONOIDA U SMJESAMA VODE I NIŽIH ALKOHOLA

### MODELING OF SOLUBILITY OF FLAVONOIDS IN WATER AND LOWER ALCOHOLS MIXTURES

**Vedrana Zaninović, Marko Rogošić, Kristina Zagajski Kučan**

Sveučilište u Zagrebu Fakultet kemijskog inženjerstva i tehnologije, Trg Marka Marulića 19, 10000 Zagreb, Hrvatska  
vzaninovi@fkit.unizg.hr

Flavonoidi su polifenolni spojevi čija antioksidativna, antiupalna, antimutagena i antikancerogena svojstva imaju ulogu u očuvanju ljudskoga zdravlja. Iz tog razloga predmet su mnogih istraživanja kako bi se najdjelotvornije mogli primijeniti u medicinske svrhe. U ovom radu opisano je modeliranje topljivosti flavonoida (daidzein, kvercetin i naringenin) u smjesama vode i nižih alkohola (etanol i metanol). Izračunati su interakcijski parametri Wilsonova modela koeficijenta aktivnosti iz eksperimentalnih podataka o topljivosti flavonoida u smjesama vode i nižih alkohola preuzetih iz literature [1-3]. Parametri dobiveni iz dvokomponentnih sustava flavonoid-voda i flavonoid-alkohol preneseni su u trokomponentni sustav. Grafički su opisana slaganja modela s eksperimentalnim rezultatima u  $x$ - $T$  dijagramu.

- [1] G. Yang et al., J. Mol. Liq. 180 (2013) 160-163.
- [2] A. Daneshfar et al., J. Chem. Eng. Data 55 (2010) 934-3936.
- [3] P. Zhang et al., J. Chem. Eng. Data 58 (2013) 2402-2404.

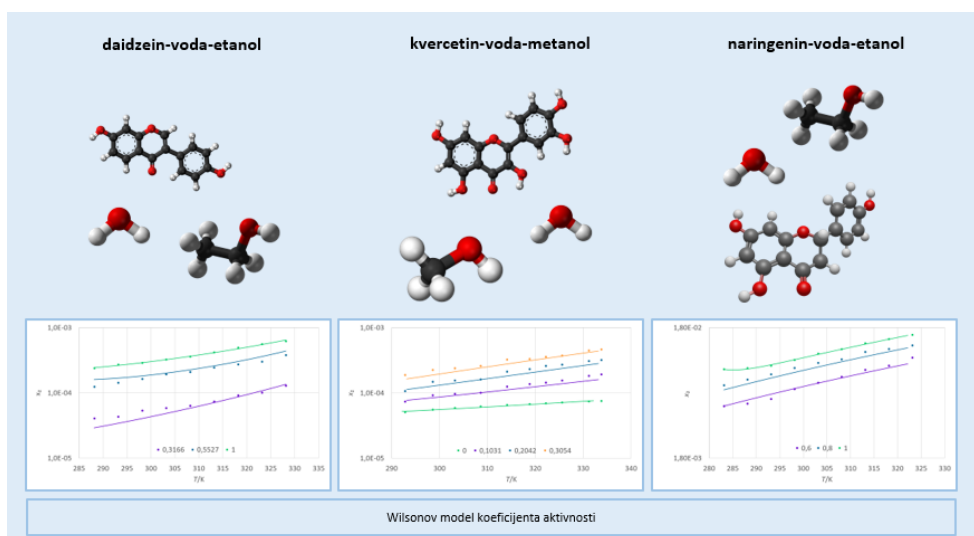

# **Primijenjena kemija** *Applied chemistry*



## UMREŽAVANJE MONOSLOJEVA STEARINSKE KISELINE NA VATERITU KAO POTENCIJAL KOD ISPORUKE LIJEKOVA

## CROSSLINKING OF STEARIC ACID MONOLAYERS ON VATERITE AS A POTENTIAL IN DRUG DELIVERY

**Helena Bach-Rojecky, Marija Mirosavljević, Damir Kralj, Katarina Marušić**

Institut Ruđer Bošković, Bijenička cesta 54, 10000 Zagreb, Hrvatska  
hbachroj@irb.hr

Biokompatibilni nanomaterijali s velikom specifičnom površinom imaju povećanu sposobnost interakcije s tjelesnim stanicama i tkivima, omogućujući ciljanu isporuku lijekova na specifična područja u tijelu. Vaterit, metastabilna polimorfna modifikacija  $\text{CaCO}_3$ , odlikuje se upravo biokompatibilnošću, malim česticama i velikom specifičnom površinom, što omogućuje kontrolirano ispuštanje lijeka na određenim mjestima ili uvjetima. Vaterit dispergirani u podzasićenu vodenu otopinu se otapa i spontano transformira u termodinamički stabilan kalcit, no nanošenjem te vezanjem organskih molekula na njegovu površinu moguće je kontrolirati te procese. Unapređenjem stabilnosti materijala nanošenjem biokompatibilnih nanoprevlaka na površinu vaterita stvara se znatno stabilniji mikrosustav, koji se može bolje i duže kontrolirati. Masne kiseline imaju sposobnost adsorpcije na površinu vaterita u obliku organiziranog monosloja pri čemu se karboksilna skupina masne kiseline veže na površinu, dok je alifatski lanac orijentiran prema otopini. Korištenjem ionizirajućeg zračenja dolazi do stvaranja slobodnih radikala koji pak mogu inicirati umrežavanje alifatskih lanaca, formirajući polimernu nanoprevlaku na površini vaterita. Radijacijsko umrežavanje je brzo i homogeno, odvija se pri sobnoj temperaturi, ne zahtjeva upotrebu toksičnih otapala i inicijatora, dok ujedno osigurava sterilizaciju materijala. Sve navedeno čini rezultirajuću strukturu (organsko-anorganski kompozit) prikladnom za primjenu u isporuci lijekova.

U ovom radu istraživani su uvjeti nanošenja samoorganizirajućih molekularnih slojeva (SAMova) stearinske kiseline (SK) na površinu vaterita te njihovog umrežavanja  $\gamma$ -zračenjem te svojstva takvih materijala. Vaterit dobiven taloženjem iz sustava  $\text{Na}_2\text{CO}_3$  i  $\text{CaCl}_2$ , naknadno je izložen otopini SK prilikom čega dolazi do njene adsorpcije. Nakon filtriranja i sušenja, molekule SK su izlagane  $\gamma$ -zračenju u prisutnosti i bez prisutnosti kisika, pri različitim dozama zračenja. Određivana je hidrofobnost sustava mjerenjem kontaktnog kuta, dok je kolorimetrija korištena za određivanje promjene boje, a morfološka i strukturna svojstva površine određivana su FTIR i TGA analizom. Pretražna elektronska mikroskopija (SEM) korištena je za karakterizaciju topografije uzoraka. Dobiveni rezultati su pokazali da je nakon izlaganja  $\gamma$ -zračenju došlo do degradacije materijala u prisutnosti kisika, dok je u sustavu bez kisika došlo do povećanja hidrofobnosti, što ukazuje na umrežavanje SK.

92

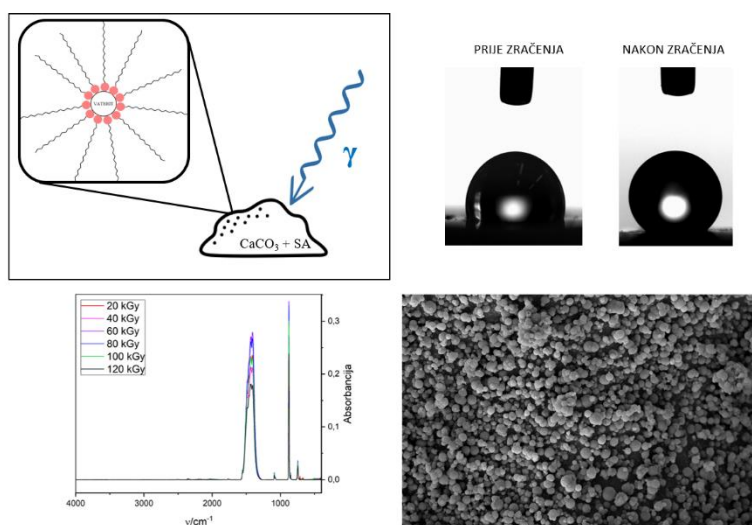

# ONE-POT SINTEZA I ANALIZA SUPRAMOLEKULSKIH INTERAKCIJA BOKONJUGATA OKSAZOLINA I AMINOKISELINA

## ONE-POT SYNTHESIS AND SUPRAMOLECULAR INTERACTION ANALYSIS OF OXAZOLINE AMINO ACID BIOCONJUGATES

**Marija Bakija, Berislav Perić, Srećko I. Kirin**

Institut Ruđer Bošković, Bijenička cesta 54, 10000 Zagreb, Hrvatska  
Marija.Bakija@irb.hr

Synthetic pathways, characterizations and applications of 2-oxazoline derivatives have been comprehensively reviewed as early as the 1970s.[1] Previously reported compounds are predominantly bis- or tris-oxazoline derivatives, while research on mono-oxazolines is considerably more scarce.[2] This is mostly due to the incomparable effectiveness of the bis-oxazoline ligands in comparison to mono-oxazolines in catalysis, which has been the main focus of the application of oxazoline derivatives in the last 30 years.[3] In addition, reports on small oxazoline-containing compounds capable of supramolecular interactions are even less published, pertaining mostly to various metal complex derivatives.[4] Generally, amino acid bioconjugates in particular have shown a useful tendency for non-covalent interactions which have been utilized to form non-metal-containing supramolecular compounds.[5] Furthermore, amino acid and peptide precursors are readily available and offer a facile method for incorporating chirality into the structure. Taking this into consideration, the three main building blocks of bioconjugates **1** presented in this study are an oxazoline ring (blue), a central aromatic unit (black) and an amino acid substituent (red). The nitrogen atom of the oxazoline ring can act as a hydrogen bonding acceptor; the central aromatic ring can engage in aromatic stacking, and the amino acid substituent contains both hydrogen bonding acceptors and donors. For the asymmetric substitution of the central aromatic unit with  $\alpha$ -amino alcohol and amino acid substituents containing different substitution patterns, synthetic approaches *via* one-pot method and *via* protecting groups are compared. The amino alcohol substituents of the precursors **3-4** are cyclized to yield a new set of oxazoline-amino acid bioconjugates. The synthesized bioconjugates **1** are then screened for their ability to participate in supramolecular interactions in solid state using SC-XRD diffraction and in solution using NMR and CD spectroscopies, and a selected example is further analyzed by DFT calculations.

93

- [1] M. Gomez et al., *Coord. Chem. Rev.* (1999) 769–835.  
 [2] H. Wang et al., *J. Am. Chem. Soc.* (2018) 3542–3546.  
 [3] R. Connon, et al., *Chem. Rev.* (2021) 6373–6521.  
 [4] M.W. Chojnacka et al., *Z. Naturforsch. B* (2020) 371–377.  
 [5] M. Raynal et al., *Phys. Chem. Chem. Phys.* (2021) 5207–5221.

This work was supported by CAT Pharma (KK.01.1.1.04.0013), by CSF project Cage Cat (IP-2022-10-8456) and CSF doctoral scholarship to Marija Bakija (DOK-2021-02-7366).

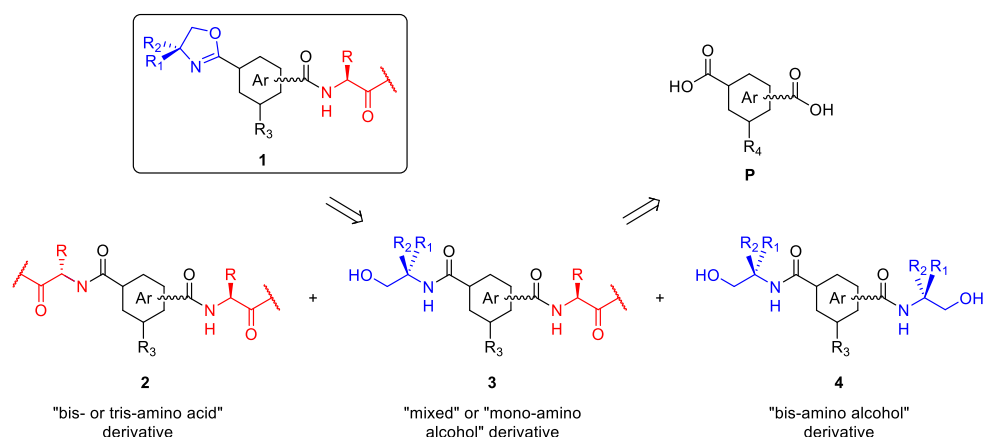

Figure 1. Disconnection scheme with general structures of oxazoline amino acids **1**, intermediates **2**, **3** and **4** and precursors **P**.  $R_3 = \text{H}$ , **amino acid** or **amino alcohol**.  $R_4 = \text{H}$  or  $-\text{COOH}$ .

# SINTEZA I BIOLOŠKA AKTIVNOST NOVIH DERIVATA INDENA

## SYNTHESIS AND BIOLOGICAL ACTIVITY OF NEW INDENE DERIVATIVES

**Nikica Baričević, Vilma Lovrinčević, Dragana Vuk**

University of Zagreb Faculty of Chemical Engineering and Technology, Trg Marka Marulića 19, 10000 Zagreb, Croatia  
nbaricevi@fkit.unizg.hr

Indene derivatives, a diverse group of organic compounds, exhibit significant biological effects, including antibacterial, antiviral, antitumor, antioxidant, anti-inflammatory, and antidepressant activities. With notable potential in bacterial and viral infections, cancer treatment, and overall health through antioxidant properties, these compounds represent promising candidates for pharmaceutical research and development [1]. Their structure allows for specific adaptations to interact with biological targets, offering possibilities for the development of new therapeutic approaches focused on complex metabolic pathways in the body [2].

The primary goal of this study is to investigate and enhance a synthetic route for new derivatives of indene, which will be the focus of upcoming biological investigations. This synthetic process includes two main reactions. Initially, functionalization of the indene core takes place, followed by reduction with lithium aluminum hydride to final products. Furthermore, the antifungal and antibacterial activity of the compounds will be investigated, and the results will be discussed.

- [1] R. D. Barry, Chem. Rev. 64 (1964) 229 – 260.  
[2] P. Prasher and M. Sharma, ChemistrySelect 6 (2021) 2658-2677.

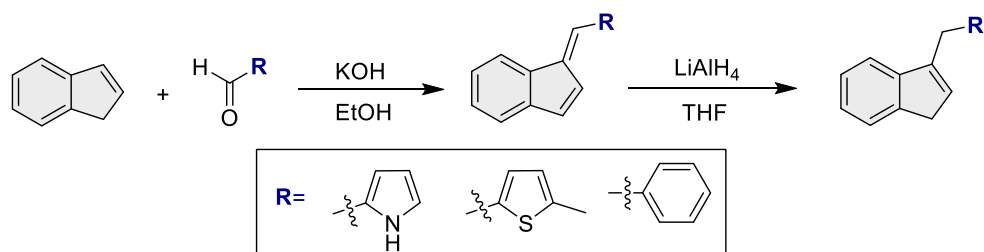

## COMPARISON OF MPAES AND ICP-MS FOR THE DETERMINATION OF POTENTIALLY TOXIC ELEMENTS IN (POLLUTED) PLANT MATERIAL

**Ramazan Baysal, Michaela Zeiner**

Örebro University, School of Science and Technology, Man-Technology-Environment Research Centre, 5  
Fakultetsgatan 1, 70182, Örebro, Sweden  
ramazanbaysal00@hotmail.com

Pine needles have been studied worldwide, particularly in areas affected by heavy metal pollution from traffic and industrial activities. These studies aim to assess the extent to which pine needles can serve as bio-monitors of environmental contamination, especially with heavy toxic metals and due to them being present all year round. Another type of contamination from heavy metals can arise, for example, from shooting ranges [1].

Shooting ranges play a crucial role in providing a controlled environment for firearm enthusiasts and professionals to practice their skills. However, the environmental consequences of shooting range activities often go unnoticed. The discharge of lead and other heavy metals poses a serious threat to ecosystems and public health. An old closed Shooting Range named Munkatorp Shooting Range, located in Sweden Örebro, has been looked at closely for causing heavy pollution specifically heavy metals. There are plans to decontaminate the area, but so far, it seems that no action has been taken. One of the most significant pollutants associated with shooting ranges is lead. The primary source of lead contamination is ammunition, as bullets are typically made of lead or contain lead components. When fired, these bullets release lead particles into the environment, contaminating the soil and water. Over time, the accumulation of lead in the ecosystem can have detrimental effects on plants, animals, and even human health [2].

Four sampling points were identified within the Munkatorp shooting range, and pine needle samples were collected for analysis. Before initiating the analysis, the needle samples underwent a thorough preparation procedure. Initially, the pine needle samples were washed with nitric acid solution, followed by drying in an oven until reaching a constant weight. The needles were then homogenized into a powder using a mortar and pestle. Triplicate preparations were made for each of the four distinct needle samples, and these preparations underwent a digestion method. The digestion method is an open digestion technique, wherein the samples were heated using a water bath. The solution used in this process consisted of nitric acid, MilliQ water, and hydrogen peroxide. Hydrogen peroxide was added every hour to compensate for its consumption during the process. The samples were considered complete when all the pine needles had completely dissolved in the solution. The digestion solutions were then diluted with MilliQ water and finally filtered using a syringe with a 0.2 µm filter. The samples will then be analyzed using Microwave Plasma Atomic Emission Spectroscopy (MPAES) and Inductively Coupled Plasma Mass Spectrometry (ICP-MS). This research investigates the efficiency of two elemental analysis techniques, Microwave Plasma Atomic Emission Spectroscopy (MPAES) and Inductively Coupled Plasma Mass Spectrometry (ICP-MS), for determining elemental composition in polluted pine plant material. This study focuses on optimizing analytical parameters for both methods and evaluating their respective capabilities in terms of sensitivity, precision, and accuracy. The results obtained from MPAES and ICP-MS are compared to assess the reliability of each technique in identifying and quantifying elements present in the samples.

- [1] M. Zeiner et al., *Molecules* 26 (2021) 3318.  
[2] J. Bai, X. Zhao, *Toxics* 8 (2020) 32.



## UTJECAJ NAČINA DEPOZICIJE I ELEKTRODNOG MATERIJALA NA NANOŠENJE BERLINSKOG MODRILA U ULOZI UMJETNE PEROKSIDAZE

### THE EFFECT OF DEPOSITION METHOD AND ELECTRODE MATERIAL ON DEPOSITED PRUSSIAN BLUE AS ARTIFICIAL PEROXIDASE

**Željka Boček, Marko Zubak, Petar Kassal**

Sveučilište u Zagrebu Fakultet kemijskog inženjerstva i tehnologije, Trg Marka Marulića 19, 10000 Zagreb, Hrvatska  
zbocek@fkit.unizg.hr

Jedan od najvećih problema voltametrijskih biosenzora na bazi enzima oksidaza je visoki prenapon potreban za oksidaciju vodikova peroksida (~0,7 V vs. Ag/AgCl), čijom se detekcijom i voltametrijskom kvantifikacijom može indirektno izmjeriti količina analita od interesa. Na tako visokom potencijalu mogu se oksidirati i razne interferirajuće tvari često prisutne u realnim uzorcima (poput askorbinske ili mokraćne kiseline). Stoga se pribjegava uporabi medijatora koji kataliziraju oksidaciju ili redukciju vodikova peroksida, čime se smanjuje potreban prenapon i mogućnost potencijalne interferencije [1]. Berlinsko modrilo se zbog svoje selektivnosti na katalizu raspada vodikova peroksida još naziva i umjetnom peroksidazom, te je odličan kandidat za funkciju medijatora u biosenzorima za detekciju analita poput glukoze ili laktata [2].

Ispitan je utjecaj načina depozicije berlinskog modrila na njegova svojstva, stabilnost i funkcionalnost u ulozi umjetne peroksidaze za detekciju vodikova peroksida. Od načina depozicije, korištene su kemijska depozicija [3], elektrodepozicija [4] i nakapavanje suspenzije nanočestica berlinskog modrila [5,6] prema postupcima u navedenoj literaturi. Berlinsko modrilo nanoseno je na komercijalnu elektrodu od staklastog ugljika, komercijalne sitotiskane elektrode te *inkjet* ispisane grafenske elektrode. Karakterizacija berlinskog modrila provedena je cikličkom voltametrijom u 0,1 M KCl te je ispitan utjecaj aktivacije u otopini KCl od -0,2 V do +0,5 V brzinom 50 mV/s, utjecaj brzine snimanja voltamograma (10-100 mV/s, korak 10 mV/s) i stabilnost u fosfatnim puferima (pH 5,4; 6,4 i 7,4). Provedeno je i voltametrijsko određivanje vodikova peroksida u vodenom mediju te su izrađeni baždarni pravci radi provjere funkcionalnosti dobivenih slojeva berlinskog modrila kao medijatora.

Najbolja stabilnost i reverzibilnost berlinskog modrila postignuta je primjenom kemijske depozicije, dok se nakapavanjem suspenzije nanočestica dobiva sloj koji se lako ispiru sa svih testiranih elektroda i zahtijeva daljnje ispitivanje s njihovom poboljšanom imobilizacijom. Elektrodepozicija je ispitana na elektrodi od staklastog ugljika i na sitotiskanim elektrodama, ali zbog neponovljivosti same elektrodepozicije, nestabilnosti nastalog sloja i znatno manjih struja u odnosu na ostale metode nisu nastavljeni daljnja ispitivanja. Odabir najbolje kombinacije metode nanošenja i elektrodno materijala ključan je za daljnji razvoj biosenzora za laktat.

- [1] F. Ricci et al., *Compr. Anal. Chem.* 49 (2007) 559-584.
- [2] A. A. Karyakin et al., *Sens. Actuators B Chem.* 57 (1999) 268-273.
- [3] F. Ricci et al., *Biosens. Bioelectron.* 18 (2003) 165-174.
- [4] W. Gao et al., *Nature* 529 (2016) 509-514.
- [5] S. Cinti et al., *Sensors* 14 (2014) 14222-14234.
- [6] J. Chen et al., *Colloid Journal* 69 (2007) 660-665.

Ovaj rad financirala je Hrvatska zaklada za znanost projektom UIP-2020-02-9139.

# FOTOKEMIJSKA SINTEZA I PRIMJENA NOVIH NAFTOTRIAZOLA

## PHOTOCHEMICAL SYNTHESIS AND APPLICATION OF NEW NAPHTHOTRIAZOLES

**Karla Bulava, Karla Karadža, Milena Mlakić, Irena Škorić**

Sveučilište u Zagrebu Fakultet kemijskog inženjerstva i tehnologije, Trg Marka Marulića 19, 10000 Zagreb, Hrvatska  
 kbulava@fkit.unizg.hr, kkaradza@fkit.unizg.hr

Cilj ovoga rada bila je sinteza novih 1,2,3-triazolnih stilbena i njihovih fotokemijskih produkata kao potencijalnih biološki aktivnih spojeva [1]. Sintetizirani spojevi potencijalni su inhibitori enzima acetilkolinesteraze (AChE) i butirilkolinesteraze (BChE) te pokazuju protuupalno djelovanje. Prvi stupanj pripreve bila je sinteza triazolnih aldehida, koji su zatim s odgovarajućim trifenilfosfonijevim solima Wittigovom reakcijom prevedeni u smjese *cis*- i *trans*-izomera novih triazolostilbena. Obzirom da naftotriazoli pokazuju bolje inhibicijsko djelovanje prema kolinesterazama te protuupalno djelovanje u odnosu na triazolostilbene [2], smjese izomera novih triazolnih stilbena podvrgnute su fotokemijskim reakcijama, prilikom kojih dolazi do elektroćikličkog zatvaranja šesteročlanog prstena te aromatizacije u naftotriazole [3]. Osim bioloških ispitivanja, rade se i računalne analize potencijalnih novih inhibitora kolinesteraza i protuupalnih spojeva te ispitivanje molekuskog pristajanja (*dockinga*).

- [1] K. K. Angajala et al., SpringerPlus 5 (2016) 423.  
 [2] M. Mlakić et al., Eur. J. Med. Chem. 241 (2022) 114616.  
 [3] I. Odak, I. Škorić, Sveučilišni udžbenik, Sveučilište u Zagrebu FKIT, Zagreb, 2017, 77-85.

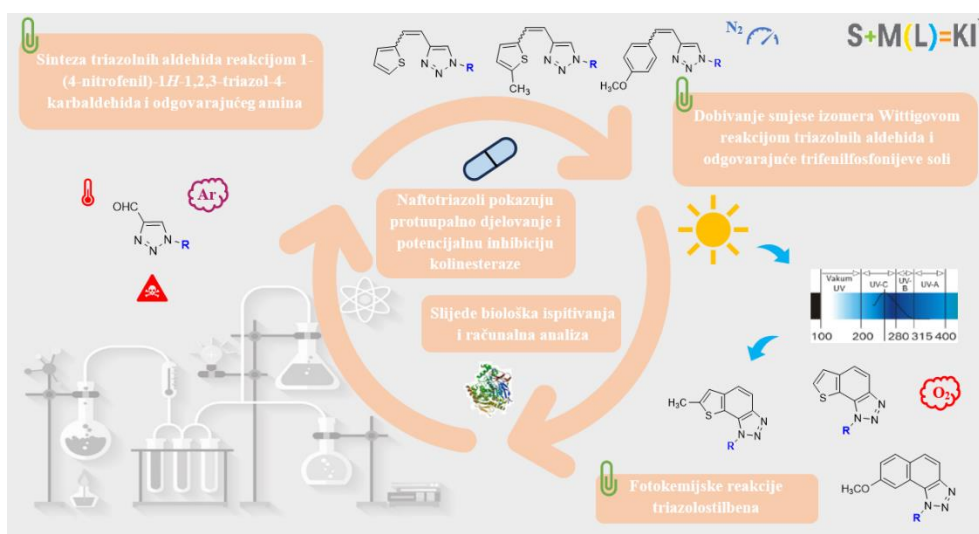

## HORNED MELON PEEL VALORIZATION USING ECO-FRIENDLY CLOUD POINT EXTRACTION

**Teodora Cvanić, Anja Saveljić, Jelena Vulić, Jasna Čanadanović-Brunet, Gordana Četković, Olja Šovljanski, Vanja Travičić**

University of Novi Sad, Faculty of Technology Novi Sad, Bulevar Cara Lazara 1, 21000 Novi Sad, Serbia  
teodora.cvanic@uns.ac.rs

Horned melon is a fruit that belongs to the *Cucurbitaceae* family, originally from Africa, but nowadays has widespread around the world. This fruit has been used by humans as a culinary specialty for a long time. However, only the inner parts are edible, while the peel is discarded [1]. Horned melon peel extracts contain phenolics, alkaloids, steroids, glycosides, and carotenoids, therefore, it presents a valuable source of different bioactive compounds. Considering that the accumulation of agricultural waste presents an enormous ecological and financial issue, a large number of scientists are working to discover a long-term solution for this growing issue. Recovery of the beneficial compounds is one of the potential uses for this wasted material [2]. Among the methods for extraction of bioactive compounds is cloud point extraction which is an innovative technique for the efficient solid-liquid extraction of polyphenols from different matrixes. It represents a low-cost, non-toxic, and simple method that can concentrate a variety of analytes. This method includes the use of non-ionic surfactants that are harmless reagents and water as the principal solvent, where nonionic surfactants when heated to or above the threshold temperature, tend to separate from the bulk solution and create micelles, or in other words, clouds. Furthermore, the obtained surfactant solution rich in valuable compounds does not require additional purification steps [3]. In this study, utilization of the Cloud point extraction method in the extraction of crude extract of horned melon peel was performed. The study aimed to optimize the process of extraction. The first step included the selection of non-ionic surfactants (Span 85, Triton X-100, Cetareth 12, and Tween 80), where 4 output values were: extract yield, the total content of polyphenolics and carotenoids, and the DPPH test. The sample with Tween 80 showed the highest values of observed parameters, where extract yield was 47,06%, total phenolic content was 207,16 mg GAE/g dw, the content of carotenoids was 8,74 mg  $\beta$  car/100g dw and DPPH was 273,48  $\mu$ M TEAC/100g dw. The next step included optimization of surfactant concentration that was 2, 4, 6, 8, and 10% (w/w). The best results are spotted for 10% (w/w) of Tween 80, where extract yield was 56,25 %, total phenolic content was 224,11 mg GAE/100g dw, the content of carotenoids was 10,61 mg  $\beta$  car/100g dw, and DPPH was 420,31  $\mu$ M TEAC/100g dw. The future perspective is to optimize solid: liquid ratio, pH value, time and temperature of extraction, etc.

98

- [1] L. Ferrara, Clin. Nutr. Metab. 1 (2018) 1-2.  
[2] V. Šeregelj et al., Processes 10 (2022) 94.  
[3] D. Sazdanić et al., J. Appl. Res. Med. Aromat. Plants 32 (2023) 100439.

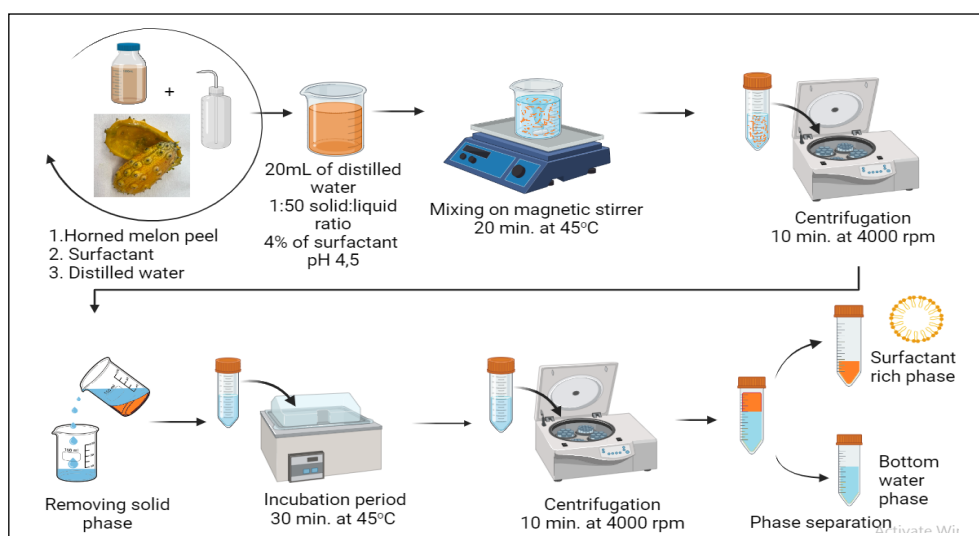

## ODREĐIVANJE FARMACEUTIKA U VODI – RAZVOJ KROMATOGRFSKE METODE, EKSTRAKCIJA I VALIDACIJA

### DETERMINATION OF PHARMACEUTICALS IN WATER – CHROMATOGRAPHIC METHOD DEVELOPMENT, EXTRACTION AND VALIDATION

**Leona Čakić, Stjepan Jozinović, Kristina Tolić Čop, Dragana Mutavdžić Pavlović**

University of Zagreb Faculty of Chemical Engineering and Technology, Trg Marka Marulića 19, 10000 Zagreb, Hrvatska  
lcakic@fkit.unizg.hr; sjozinovi@fkit.unizg.hr

The intensive use and consumption of pharmaceuticals leads to their increased appearance in various areas of the environment (soil, sediment, ground water, surface water). The recent increased awareness of their harmful effects on the environment and their resistance to biodegradation has led to an increased need for their monitoring. According to the above, the aim of this research was to develop an analytical method for the simultaneous analysis of 12 pharmaceuticals (amoxicillin, atenolol, procaine, ofloxacin, sulfamethazine, sulfamethoxazole, torasemide, carbamazepine, dexamethasone,  $\beta$ -estradiol, diazepam, diclofenac) with different physical and chemical properties. The method development and validation of the gradient-based method as well as the analysis of samples after extraction experiments, were done by HPLC coupled with DAD detector (HPLC-DAD). The quantification of analytes was performed at five different wavelengths, based on the absorption spectra of each pharmaceutical. The examined validation parameters included linearity, limit of detection (LOD), limit of quantitation (LOQ), sensitivity, precision, accuracy, range and robustness. The developed gradient method was proven to be linear for all pharmaceuticals approved with  $R^2 > 0.99$ . The minimum LOD was determined to be  $0.05 \text{ mg L}^{-1}$ , and minimum LOQ to be  $0.1 \text{ mg L}^{-1}$ . The solid-phase extraction of the pharmaceuticals mixture was developed and optimized in spring water collected during the winter months in the Mikulići spring, Zagreb, where different extraction parameters were examined to achieve the best recovery for the pharmaceutical mixture. The optimized method for the mixture involves the use of 100 mL of spring water with a pH value of 8 with elution in two portions of 2 mL of methanol each. During validation, the linearity of the SPE-HPLC-DAD method was determined to be in the interval from  $0.0001$  to  $0.0005 \text{ mg L}^{-1}$ . The method proved to be reproducible with extraction recoveries of  $100 \pm 10\%$  for the majority of pharmaceuticals in the mixture. Finally, the SPE-HPLC-DAD method was applied to two real samples of hospital wastewater, where the majority of pharmaceuticals below LOQ were confirmed. Of all the pharmaceuticals tested, carbamazepine stands out with the highest measured concentration of  $0.00512 \text{ mg L}^{-1}$ .

99

This study was supported by the Croatian Science Foundation under the project number HRZZ-IP-2022-10-4400 entitled *Development of molecularly imprinted polymers for use in analysis of pharmaceuticals and during advanced water treatment processes (MIPdePharma)*.

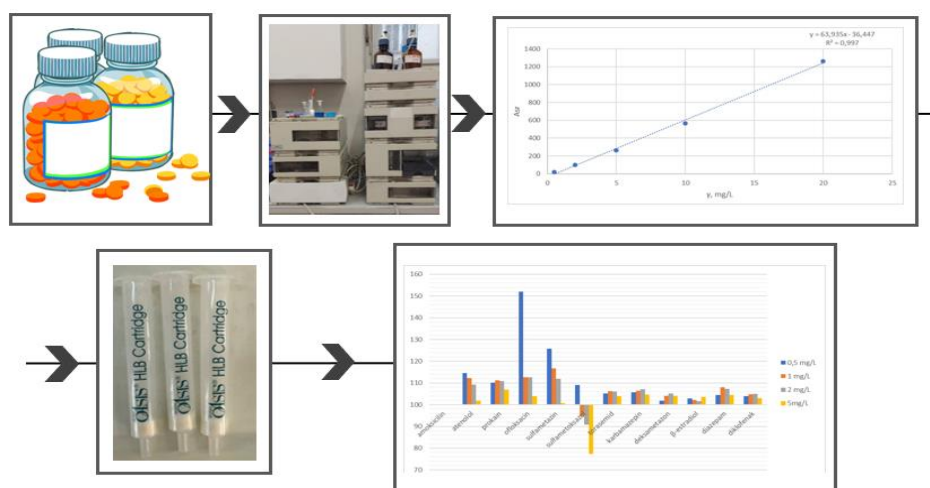



# UV-LED FOTOLITIČKA RAZGRADNJA *N*-NITROZOPIROLIDINA

## UV-LED PHOTOLYTIC DEGRADATION OF *N*-NITROSOPYRROLIDINE

**Katarina Marija Drmić, Josip Horvat, Sandra Babić**

Sveučilište u Zagrebu Fakultet kemijskog inženjerstva i tehnologije, Trg Marka Marulića 19, 10000 Zagreb, Hrvatska  
jhorvat@fkit.unizg.hr

Dezinfekcija vode za ljudsku potrošnju i bazenske vode je neophodna kako bi se osigurala zdravstveno ispravna voda sigurna za korisnike. Međutim, reakcijom dezinficijensa s prirodnom organskom tvari (NOM) i anorganskim tvarima prisutnim u vodi nastaju dezinfekcijski nusprodukti (DNP) koji mogu predstavljati rizik za zdravlje i za okoliš [1]. Istraživanja DNP-a uglavnom su fokusirana na trihalometane i haloocetene kiseline iako je pokazano da su *N*-nitrozamini (NA) kancerogeniji [2]. Učestala detekcija DNP-a ukazuje da postojeći postupci obrade vode nisu adekvatni ni učinkoviti u njihovom uklanjanju te postoji potreba za razvojem novih, naprednih postupaka koji će učinkovito uklanjati zdravstveno štetne DNP-e. Prema do sada objavljenim radovima, membranski procesi i napredni oksidacijski procesi (AOP) kao i biorazgradnja pokazuju znatan potencijal za učinkovito uklanjanje DNP-a [3]. Za primjenu AOP-a često su potrebne značajne količine električne energije, pri čemu je izvor zračenja kritični element. Stoga, kako bi se osigurali ekonomski opravdani AOP-i, posljednjih godina istražuje se primjena izvora UV-zračenja s malom potrošnjom energije. U odnosu na tradicionalne UV-lampe, svjetleće diode (LED) imaju niz prednosti poput bolje učinkovitosti u pretvaranju električne energije (visoki kvantni prinos) i dužeg životnog vijeka te manjeg štetnog utjecaj na okoliš jer ne sadrže toksične tvari poput žive.

U ovom radu istražena je fotolitička razgradnja *N*-nitrozopirrolidina (NPYR) u vodi, kao predstavnika NA, korištenjem UV-LED fotoreaktora. Kao izvor zračenja, korištene su UV-LED diode različitih valnih duljina, UV-A ( $\lambda = 365$  nm) i UV-C ( $\lambda = 272$  nm). Istražen je utjecaj valne duljine zračenja, udaljenosti između LED dioda i reaktora te broja LED dioda na kinetiku razgradnje NPYR-a. Primijećeno je da smanjenjem udaljenosti UV-LED dioda od reaktora dolazi do brže razgradnje NPYR-a. Primjenom UV-C zračenja razgradnja NPYR-a bila je sporija u odnosu kada je korišteno UV-A zračenje. Iz dobivenih rezultata može se zaključiti da je fotoreaktor s najvećim brojem LED dioda valne duljine 365 nm i njihovom najmanjom udaljenosti od reaktora bio najučinkovitiji u razgradnji NPYR-a tijekom vremenskog perioda od 60 minuta.

- [1] E. Abilleira et al., Heliyon 9 (2023) e13673.  
[2] T. Maqbool et al., Sci. Total Environ. 783 (2021) 146982.  
[3] L. Yang et al., Environ. Int. 121 (2018) 1039–1057.

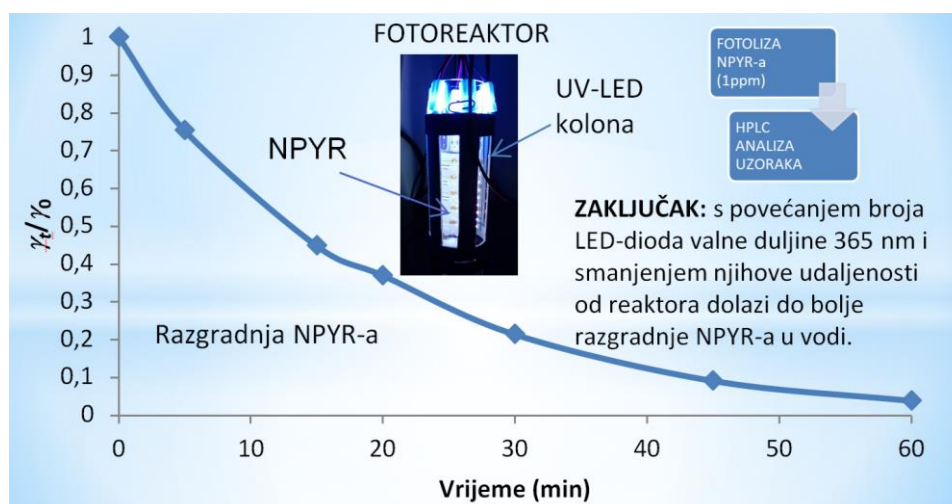

## OPTIMIZIRANJE SINTETSKIH METODA ZA PRIPRAVU 2-CIJANOMETILBENZOKSAZOLA

## OPTIMIZING OF SYNTHETIC METHODS FOR THE PREPARATION OF 2-CYANOMETHYLBENZOXAZOLE

**Marina Galić, Tamara Rohtek, Marijana Hranjec**

University of Zagreb Faculty of Chemical Engineering and Technology, Trg Marka Marulića 19, 10000 Zagreb,  
Croatia  
mgalic@fkit.unizg.hr

Today, in the organic and medicinal chemistry, heterocyclic compounds which are used as starting molecules in many synthetic pathways play an important role in the synthesis of biologically active compounds [1,2]. One of the most commonly used heterocyclic compounds is benzoxazole and its derivatives, which are assumed to have versatile reactivity and biological activities due to their structural similarity to the nucleobases guanine and adenine. Mostly used reactive precursors are 2-substituted benzoxazoles, whose synthesis is mainly carried out at high temperatures using a large amount of organic solvents or strong acids and expensive catalysts.[3] For environmental, health and economic reasons it is of utmost importance to develop new synthetic methods in organic chemistry that use minimal amounts of toxic organic solvent.[4]

Herein we present the optimization of synthetic methods for the preparation of differently substituted 2-cyanomethylbenzoxazoles. The targeted compounds were synthesized by heating the corresponding aminophenols and ethyl 2-cyanoacetimidate hydrochloride under different synthetic conditions. In addition to conventional synthetic organic methods [5], compounds were also synthesized using green chemistry synthetic methods like glycerol as solvent, by heating the reactants in solvent free reactions or microwave-assisted synthesis using methanol and glycerol as solvents. The structures of the prepared compounds were confirmed by means of  $^1\text{H}$ - and  $^{13}\text{C}$ -NMR spectroscopy. The targeted 2-cyanomethylbenzoxazoles will be used as precursors for further syntheses of potentially biologically active benzoxazole derivatives.

101

- [1] U. Kamali et al., Asian J. Pharm. Clin. 13 (2020) 28-41.
- [2] S. Dwivedi et al., World J. Pharm. Res. 12 (2023) 979-994.
- [3] X. K. Wong and K.Y. Yeong, ChemMedChem 16 (2021) 3237–3262.
- [4] D. R. Joshi and N. Adhikari, J. Pharm. Res. Int. 28 (2019) 1–18.
- [5] H. B. Ammar et al., Phys. Chem. News 9 (2003) 137-139.

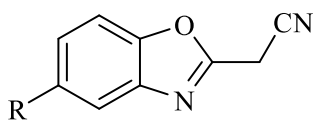

- 1 R = H
- 2 R = Br
- 3 R = *t*-Bu



# ANTIOKSIDATIVNA AKTIVNOST PEPTIDOMIMETIKA PRIPRAVLJENIH IZ RAZLIČITIH FERROCENSKIH KALUPA I HIDROFOBNIH AMINOKISELINA

## ANTIOXIDATIVE ACTIVITY OF PEPTIDOMIMETICS DERIVED FROM DIFFERENT FERROCENE SCAFFOLDS AND HYDROPHOBIC AMINO ACIDS

**Leona Galić, Vita Vučičević, Karla Hanousek Čiča, Jasna Mrvčić, Veronika Kovač, Lidija Barišić and Monika Kovačević**

University of Zagreb Faculty of Food Technology and Biotechnology, Pierottijeva 6, 10000 Zagreb, Croatia  
lgalic1@pbf.hr, vvucicevic@pbf.hr

It was found that ferrocene-peptide conjugates adopt chiral organized structures through intramolecular hydrogen bonding, which is a prerequisite for the formation of 3D structures and the function of biological systems. It could be shown that the hydrogen bond donor/acceptor properties of the turn-inducing ferrocene scaffolds regulate the pattern of the hydrogen bonds of the derived peptides: 10-membered rings with hydrogen bonds between the strands were formed in the conjugates of amino acids or peptides with dicarbonyl-functionalized ferrocene core (Fcd), 12-membered rings in conjugates with -NH-Fn-CO- moiety (Fca), while conjugation with diamino-functionalized ferrocene (Fcda) resulted in 14-membered rings with hydrogen bonds [1-5].

Herein, we report the synthesis of conjugates I, II and III, which consist of three different types of turn-inducing ferrocene scaffolds (Fcd, Fca or Fcda) and Val, Leu and Phe, respectively (Fig. 1). In addition, the influence of the structurally different ferrocene scaffolds and the bulkiness of amino acid side chains on the antioxidant activity of the derived bioconjugates is investigated using the DPPH and ABTS methods.

- [1] J. Li et al., *Front. Neurosci.* 11 (2017) 1-18.  
[2] M. Kovačević et al., *Dalton Trans.* 44 (2015) 16405-16420.  
[3] M. Kovačević et al., *Chem. Eur. J.* 23 (2017) 10372-10395.  
[4] M. Kovačević et al., *Int. J. Mol. Sci.* 23 (2022) 12233.  
[5] M. Kovačević et al., *Inorganics* 11 (2023), 29.

This work has been fully supported by Croatian Science Foundation under the project IP-2020-02-9162.

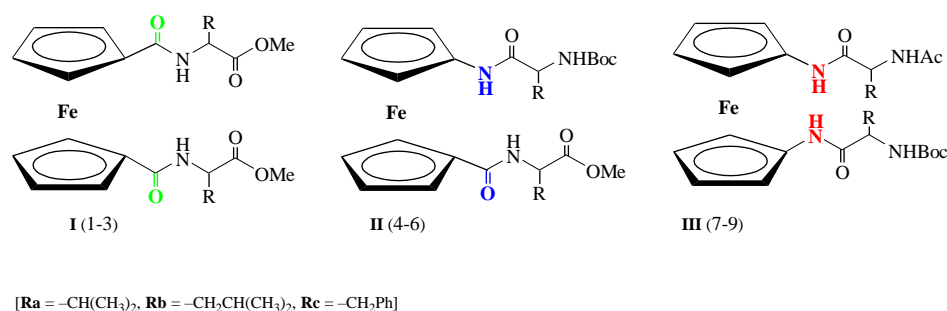
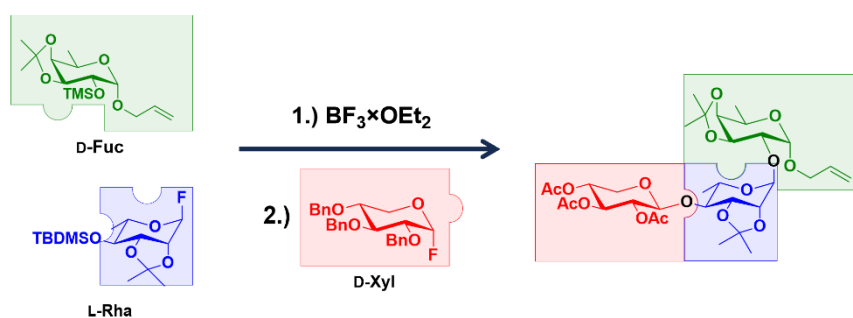

Figure 1. Symmetrically disubstituted ferrocene peptides 1-9

EFFICIENT ONE-POT SYNTHESIS OF TRISACCHARIDE DOMAIN FROM THE *QUILLAJA* SAPONIN**Filip Grdović, Đani Škalamera**University of Zagreb Faculty of Science, Department of Chemistry, Horvatovac 102a, 10000 Zagreb, Croatia  
filip.grdovic@chem.pmf.hr

Oligosaccharides and glycoconjugates play an important role in various biological processes, including viral and bacterial infections, cell growth and development, intercellular signaling, and immunological responses. In order to elucidate their mechanisms of action and molecular interactions, it is necessary to synthetically prepare these compounds in the laboratory setting due to their typically low concentrations and the challenges associated with their separation from natural sources. Recent advances in natural carbohydrate synthesis involve the utilization of glycosyl fluorides as versatile glycosyl donors[1] and silyl ethers as glycosyl acceptors.[2] Using a combination of these precursors opens up the possibility of a one-pot synthesis that simplifies the usual multi-step synthesis in a way that eliminates the need to purify each intermediate and thus saves time, solvents and reagents. The reaction between the mentioned precursors results in an O-glycosidic bond and a stable and easily removable by-product, trialkylsilicon fluoride.[2] The one-pot synthesis approach involves sequential reactions of the monosaccharide building block with other saccharide components and reagents within a reaction vessel (flask), eliminating the necessity for isolation and purification at each stage. Using this method, multiple glycosylations can be connected in one process, furnishing the target oligosaccharide after a single isolation and purification step. This methodology minimizes losses and enhances overall yield. In this study, the synthesis of the trisaccharide Xyl-Rha-Fuc, a domain of the saponin QS-21, known for its potent immunoadjuvant properties, was successfully achieved. Saponin QS-21, sourced from *Quillaja saponaria* tree bark, is one of the strongest known immunoadjuvants, that has applications in vaccines for human use.[3] The expeditious and efficient one-pot synthesis of trisaccharides presented in this study paves the way for a more rapid and facile approach to generating QS-21 derivatives, thereby catalyzing the exploration of novel, more stable, and accessible immunoadjuvants.

- [1] M. Yokoyama, Carbohydr. Res. 327 (2000) 5–14.  
 [2] G. C. Sati et al., J. Am. Chem. Soc. 142 (2020) 7235-7242.  
 [3] P. Wang et al., J. Med. Chem. 62 (2019) 9976-9982.



## UTJECAJ OTAPALA I TEHNIKE IONIZACIJE NA KVANTITATIVNO ODREĐIVANJE *N*-NITROSO-DULOXETIN ONEČIŠĆENJA HPLC-MS METODOM

### INFLUENCE OF SOLVENT AND IONIZATION TECHNIQUE ON THE QUANTITATIVE DETERMINATION OF *N*-NITROSO-DULOXETINE IMPURITY BY HPLC-MS METHOD

**Ivana Gusić<sup>1</sup>, Prasad Deshpande<sup>2</sup>, Sandra Babić<sup>3</sup>**

<sup>1</sup>Pliva d.o.o., Zagreb, Croatia

<sup>2</sup>Teva Pharmaceuticals Ireland, Co Waterford, Republic of Ireland

<sup>3</sup>University of Zagreb Faculty of Chemical Engineering and Technology, 10000 Zagreb, Croatia  
ivana.gusic@pliva.com

The HPLC coupled with mass spectrometry is a suitable technique for the analysis of *N*-nitrosamine impurities as it allows both confirmation and quantification of analytes present at low quantities in complex matrices. Methods using electrospray ionization (ESI) and using atmospheric pressure chemical ionization (APCI) have been published. ESI is mostly used for ionization of polar, thermostable substances while APCI is suitable for non-polar substances [1].

The impact of the diluent used for sample preparation is a crucial step in every analysis since the use of inappropriate diluent may lead to underestimation or overestimation of obtained results [2].

In order to ensure that reliable and accurate results are obtained for the determination of *N*-nitroso-Duloxetine in Duloxetine capsules two solvents were investigated. The used solvents were acetonitrile and 70 % methanol in water. The impact of the used diluent was additionally compared to the impact of the same on the content of *N*-nitroso-Duloxetine in drug substance of Duloxetine. It was concluded that there is no impact of used diluent on drug substance, however, by preparing the sample solution of Duloxetine capsules in acetonitrile, the content of *N*-nitroso-Duloxetine impurity was overestimated about ten times. In addition, the influence of ionization technique (electrospray vs atmospheric pressure chemical ionization) was evaluated. It was found that electrospray ionization gives a higher response of *N*-nitroso-Duloxetine.

104

[1] W. Wichitnithad et al., Talanta 254 (2023) 124102.

[2] E. Yamamoto et al., J. Pharm. Biomed. Anal. 2 (2023) 100020.

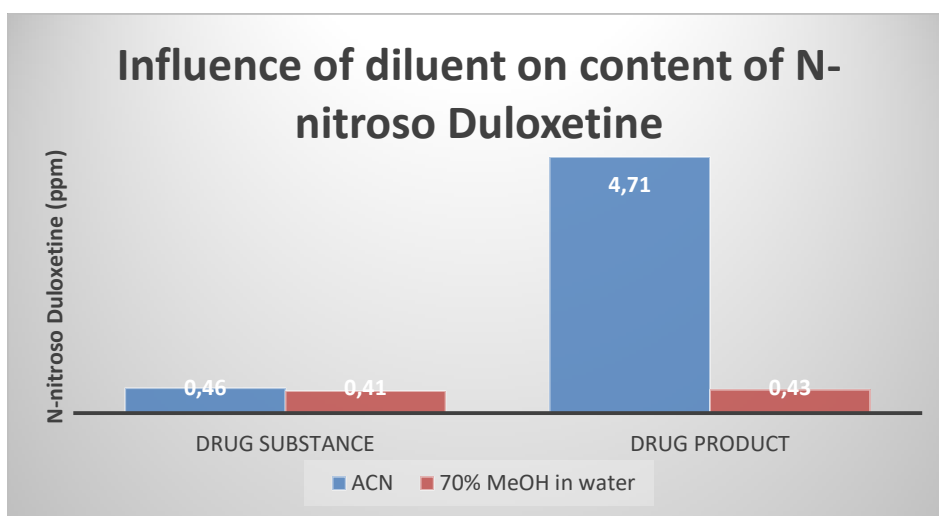

## UTJECAJ VELIČINE NANOČESTICA NA SVOJSTVA SILICIJEVA DIOKSIDA

### THE IMPACT OF NANOPARTICLE SIZE ON THE PROPERTIES OF SILICON DIOXIDE

**Antun Habajec<sup>1</sup>, Ivan Marić<sup>2</sup>, Juraj Nikolić<sup>1</sup>, Klemen Bohinc<sup>3</sup>, Davor Kovačević<sup>1</sup>**

<sup>1</sup>University of Zagreb Faculty of Science, Horvatovac 102a, 10000 Zagreb, Croatia

<sup>2</sup>Ruder Bošković Institute, Division of Materials Chemistry, Bijenička cesta 54, 10000 Zagreb, Croatia

<sup>3</sup>University of Ljubljana, Faculty of Health Sciences, Zdravstvena pot, 1000 Ljubljana, Slovenia  
ahabajec.chem@pmf.hr

Silicon dioxide (silica) nanoparticles have shown a great potential for application in a variety of fields such as catalysis, drug delivery, water remediation, and agriculture.[1] At neutral pH, silica nanoparticles carry a negative charge which influences how they interact with their surroundings, therefore understanding their properties is crucial for describing these interactions and examining potential applications. Many uses of nanoparticles rely on their high specific surface which is greater for smaller particles. However, how the change in size fully affects various properties is still a topic of interest. [2,3]

In this research, silica nanoparticles of varied and exact sizes were studied to describe the influence of size on their properties. Dynamic light scattering (DLS), scanning electron microscopy (SEM), and atomic force microscopy (AFM) were used to determine particle size and uniformity. Furthermore, energy-dispersive X-ray spectroscopy (EDX) was performed alongside SEM to confirm the purity of all samples. Surface charge of the nanoparticles was determined by particle charge detector measurements. To verify the suspension stability, zeta potential was measured. Nanoparticles were shown to be highly uniform in size by DLS, SEM, and AFM. EDX spectra confirmed that the particles did not contain impurities. It was also determined that zeta potential and surface charge both depend on size, suggesting an upward trend with increasing particle size for surface charge, while the zeta potential measurements also confirmed that the suspensions were highly stable. Because of these size dependent trends, silica nanoparticles show great potential for applications where charge properties need to be regulated.

105

- [1] A. A. Nayl et al., RSC Adv. 12 (2022) 13706-13726.  
[2] M. Barisik et al., J. Phys. Chem. C 118 (2014) 1836-1842.  
[3] J. Dolai et al., ACS Appl. Nano Mater. 4 (2021) 6471-6496

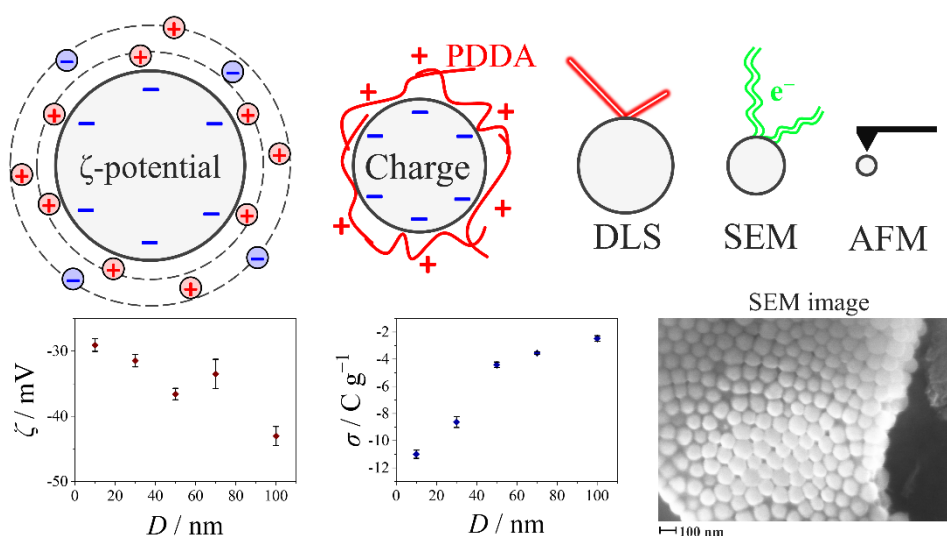

## ODREĐIVANJE SADRŽAJA Cr, Cu, Fe i Mn U SIROVOJ I KUHAANOJ RIŽI

## DETERMINATION OF CR, CU, FE, AND MN IN RAW AND COOKED RICE

**Džejna Halilović<sup>1</sup>, Emina Ramić<sup>2</sup>, Sabina Žero<sup>1</sup>, Jasna Huremović<sup>1</sup>, Lejla Klepo<sup>1</sup>, Amar Karadža<sup>1</sup>**

<sup>1</sup>University of Sarajevo, Faculty of Science, Zmaja od Bosne 33-35, Sarajevo 71000, Sarajevo, Bosnia and Herzegovina

<sup>2</sup>University of Sarajevo, Faculty of Pharmacy, Zmaja od Bosne 8, Sarajevo 71000 Sarajevo, Bosnia and Herzegovina  
emina.ramich@gmail.com

Different agricultural crops (such as rice, wheat, and soybeans) have different accumulation efficiency of heavy metals, but contamination of rice is much more common than in other crops. Rice is used daily in the diet of people all over the world; hence, the aim of this paper was to analyze and compare the Cr, Cu, Fe, and Mn content of raw and cooked rice, as well as to compare the results with previous literature research. Raw rice samples were prepared by acid digestion with the addition of 30 % hydrogen peroxide. Cooked rice was prepared by boiling raw rice samples in distilled water, after which the cooked residue was dissolved in the same way as the raw rice samples. The method of flame atomic absorption spectrometry (FAAS) was used to determine the content of the examined metals. The content of determined metals in raw rice samples ranged from: < LOD (limit of detection) - 2.51  $\mu\text{g/g}$  (Cr); 1.07-3.71  $\mu\text{g/g}$  (Cu); < LOD-113  $\mu\text{g/g}$  (Fe) and 2.76-25.96  $\mu\text{g/g}$  (Mn). The content of the analyzed metals in the cooked rice samples was in the following ranges: < LOD-0.41  $\mu\text{g/g}$  (Cr); 1.18-2.13  $\mu\text{g/g}$  (Cu); 0.43-5.90  $\mu\text{g/g}$  (Fe) and 1.00-17.97  $\mu\text{g/g}$  (Mn). The analysis showed that cooking raw rice reduces the metal content, which is very important data for human nutrition and the daily intake of metals through digestion.

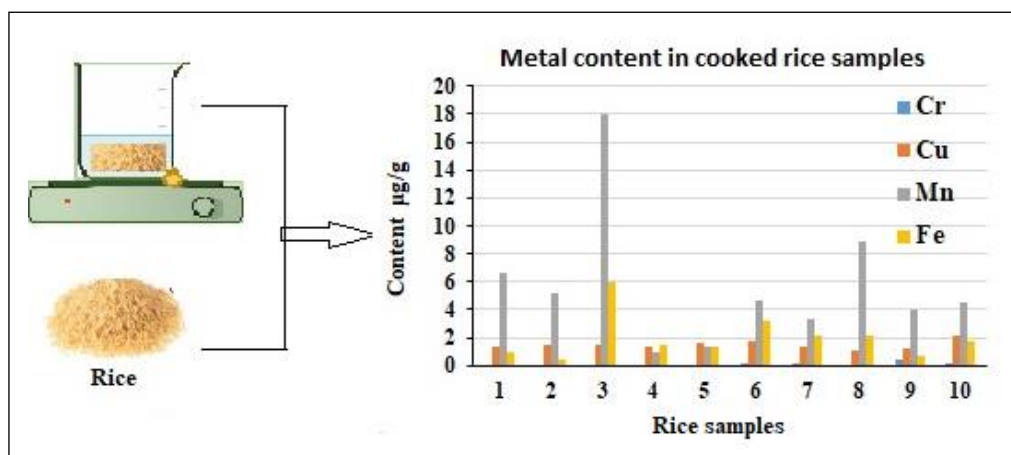

## SUDBINA NITRATA U TEKSTILNOJ OTPADNOJ VODI TIJEKOM OBRADE ULTRAFILTRACIJSKO – REVERZNO OSMOTSKIM PROCESOM

### FATE OF NITRATES IN TEXTILE WASTEWATER DURING ULTRAFILTRATION – REVERSE OSMOSIS PROCESS

**Fran Hrlić, Iva Ćurić, Davor Dolar**

Sveučilište u Zagrebu Fakultet kemijskog inženjerstva i tehnologije, Trg Marka Marulića 19, 10000 Zagreb, Hrvatska  
fhrlic@fkit.unizg.hr

Cilj ovog rada bio je obrada realne tekstilne otpadne vode (TOV) prikupljene u tekstilnoj industriji Galeb d.d., Omiš hibridnim ultrafiltracijsko – reverzno osmotskim (UF – RO) procesom te praćenje koncentracija nitrata tijekom obrade (TOV, UF permeat te RO retentat i RO permeat). Oporaba retentata vrlo je bitna iz aspekta zbrinjavanja retentata koji pokazuje određenu razinu ekološke toksičnosti, ali i kako bi se zatvorio ciklus vode, gdje bi se permeat iz RO procesa mogao koristiti ponovno u tekstilnim procesima. Rezultati pokazuju koncentraciju nitrata u TOV-u od 12.9 mg/L, dok je u UF permeatu utvrđena koncentracija od 2.47 mg/L. U RO retentatu utvrđena je viša koncentracija nitrata u odnosu na UF permeat, točnije 3.36 mg/L, s obzirom da je iskorištenje RO procesa bilo 35 %. U RO permeatu utvrđena je koncentracija nitrata od 0.18 mg/L. Dakle, UF procesom postignuto je uklanjanje nitrata od 80.9 %, dok je RO procesom postignuto dodatno uklanjanje od 92.7 %. Ukupni faktor zadržavanja nitrata hibridnim UF – RO postupkom iznosio je 98.6 %, što dovodi do zaključka da se UF – RO proces pokazao vrlo učinkovitim za uklanjanje nitrata TOV-a.

Ovaj rad financirao je NATO Science for Peace and Security Programme pod šifrom projekta G6087.

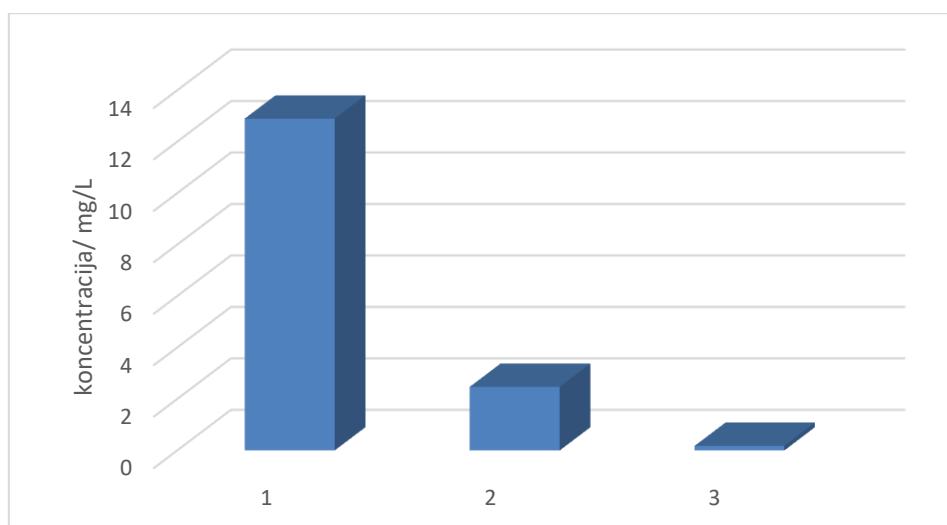

Iznosi koncentracija nitrata u TOV-u (1), UF permeatu (2) te RO permeatu (3)



# USPOREDBA SASTAVA BIFLAVONOIDA U EKSTRAKTIMA LISTOVA GINKGA (*Ginkgo biloba* L.) PRIPREMLJENIH S RAZLIČITIM OTAPALIMA

## COMPARISON OF THE BIFLAVONOID PROFILE OF GINKGO (*Ginkgo biloba* L.) LEAVES EXTRACTS PREPARED WITH DIFFERENT SOLVENTS

**Iva Jurčević Šangut, Rebeka Oreški, Dunja Šamec**

Department of Food Technology, University North, Trg dr. Žarka Dolinara 1, 48000 Koprivnica, Croatia  
ijurcevic@unin.hr

*Ginkgo biloba* L. is a widely known plant species with a unique leaf shape and medicinal properties that can help improve health. These properties are attributed to various specialized metabolites found in ginkgo extracts. One of them are biflavonoids, dimeric structures of flavonoids, and the five most abundant in ginkgo are amentoflavone, bilobetin, ginkgetin, isoginkgetin and sciadopitysin. [1] Choosing the right solvent for extraction is crucial for optimizing the extraction process. In this study, we tested the influence of four different types of extraction solvents (70% ethanol, 80% methanol, 96% ethanol and 100% methanol) on the content of polyphenols and flavonoids. The results showed that extraction with 70% ethanol gave the highest yield of polyphenols ( $38.00 \pm 0.46 \mu\text{g GAE/mg dw}$ ) compared to the other solvents. The highest content of total flavonoids was obtained by extraction with 96% ethanol ( $9.85 \pm 0.85 \mu\text{g CAE/mg dw}$ ). Although the HPLD-DAD data showed the highest content of biflavonoids in ethanolic extracts, this was not statistically significant. For further extractions, we chose 70% ethanol because it has a high yield of phenolic compounds and is less toxic compared to other solvents.

[1] D. Šamec et al., *Plants*. 11 (2022) 1381.

This work was funded by the Croatia Science Foundation under the project “Biflavonoids role in plants: *Ginkgo biloba* L. as a model system“ (UIP-2019-04-1018).

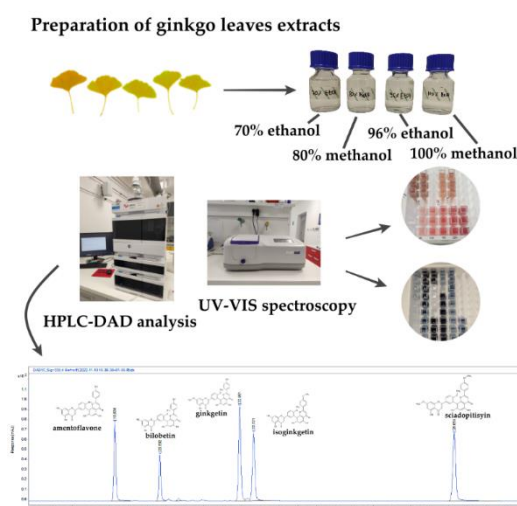

## NEUROPROTEKTIVNA SVOJSTVA POLIAMINA U IZABRANIM GLJIVAMA IZ SRBIJE: ANTI-ACETILHOLINESTERAZNE PERSPEKTIVE

### EXPLORING NEUROPROTECTIVE PROPERTIES OF POLYAMINES IN SELECTED FUNGI FROM SERBIA: ANTI-ACETYLCHOLINESTERASE PERSPECTIVES

Marko Kebert<sup>1</sup>, Milena Rašeta<sup>2</sup>, Jovana Mišković<sup>3</sup>, Milana Rakić<sup>3</sup>, Eleonora Čapelja<sup>3</sup>, Saša Kostić<sup>1</sup>, Maja Karaman<sup>3</sup>

<sup>1</sup>University of Novi Sad, Institute of Lowland Forestry and Environment, 21000 Novi Sad, Serbia

<sup>2</sup>University of Novi Sad, Faculty of Sciences, Department of Chemistry, Biochemistry and Environmental Protection, ProFungi Laboratory, 21000 Novi Sad, Serbia

<sup>3</sup>University of Novi Sad, Faculty of Sciences, Department of Biology and Ecology, ProFungi Laboratory, 21000 Novi Sad, Serbia

milena.raseta@dh.uns.ac.rs

The ongoing debate surrounding the therapeutic effectiveness of current treatments for neurodegenerative diseases, attributed to issues with bioavailability and various side effects, underscores the potential of fungi as promising neuroprotective agents, given their increasing recognition for providing natural acetylcholinesterase (AChE) enzyme inhibitors. While polysaccharides and phenolic compounds in fungi have been extensively studied for their anti-AChE activities [1], polyamines (PAs), another class of secondary metabolites, have received limited attention in previous research. The primary objective of this research was to explore the neuroprotective potential of eight edible and medicinal fungi (*Clitocybe odora*, *Clitopilus prunulus*, *Lepista nuda*, *Postia caesia*, *Morchella elata*, *Cyclocybe aegerita*, *Ganoderma applanatum*, and *G. resinaceum*) from Serbia, with a particular focus on investigating the neuroprotective capabilities of *P. caesia*, *C. odora*, *C. prunulus*, and *M. elata* for the first time. PAs amounts were measured using HPLC with fluorescent detection, and the quantification of total phenolic and total protein contents was conducted through spectrophotometric assays. The neuroprotective activity was evaluated using the Ellman assay.

*G. applanatum* and *L. nuda* demonstrated potent anti-AChE activity, attributed to synergistic effects of total protein, total phenolic content, and PAs levels. Additionally, *P. caesia* exhibited notable AChE inhibition, associated with elevated spermidine (SPD) and putrescine (PUT) levels. Furthermore, the examination of various fungi in this research has unveiled intriguing diversity in the composition and effectiveness of PAs and phenolic compounds. This underscores the potential of leveraging fungal resources for the development of therapeutic approaches for neurological disorders and dietary interventions.

109

[1] M. Karaman et al., Springer: Berlin/Heidelberg, Germany, 8 (2022) 203-257.

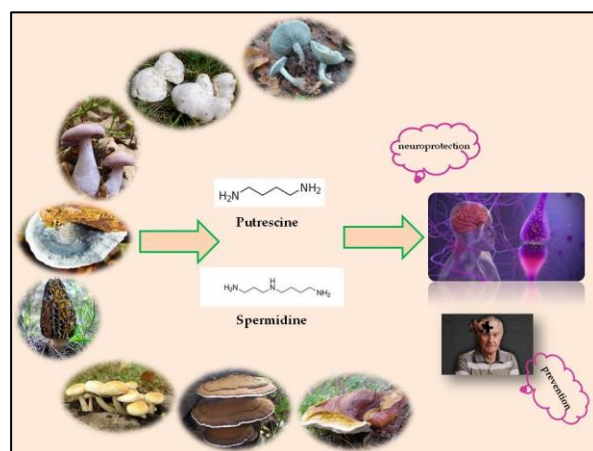

## SUBSTITUTED QUINAZOLINONES: MECHANOCHEMICAL SYNTHESIS IN NATURAL DEEP EUTECTIC SOLVENTS AND ADME PROPERTIES

**Mario Komar<sup>1</sup>, Martina Jakovljević Kovač<sup>1</sup>, Vesna Rastija<sup>2</sup>, Maja Molnar<sup>1</sup>**

<sup>1</sup> University of Osijek, Faculty of Food Technology, Josip Juraj Strossmayer Osijek, 31000 Osijek, Croatia

<sup>2</sup> University of Osijek, Faculty of Agrobiotechnical Sciences Osijek, Josip Juraj Strossmayer, 31000 Osijek, Croatia  
mkomar@ptfos.hr

Quinazolinone and its derivatives are significant biologically active building blocks in medicinal and pharmaceutical chemistry [1]. Nowadays, the main focus of chemists is replacing conventional hazardous organic solvents and the development of environmentally friendly synthetic routes for the synthesis of different heterocycles, as well as quinazolinones [2,3]. Natural deep eutectic solvents (NADESs) are a new generation of greener reaction media widely used in various processes [4]. Herein, we present a mechanochemical synthesis of novel 2-methyl-3-substituted quinazolin-4(3*H*)-one derivatives promoted with choline chloride/urea NADES. The reaction conditions such as reaction time, volume of NADESs, and number of milling balls were optimized using 2-methylbenzoxazin-4-one and 4-chloroaniline as model substrates. This practical application of milling and catalytic and solvent activity of NADES provides moderate to excellent reaction yields (45–87 %). Based on the structure of novel synthesized derivatives, we have predicted their potential activity *in silico* according to their calculated ADME properties. Some of them may lead to further optimizations of antifungal, skeletal muscle relaxant, and anticonvulsant drugs.

- [1] A. M. Alsibae et al., *Molecules* 28 (2023) 978.  
 [2] W. A. Ahmed Arafa, *R. Soc. Open Sci.* 6 (2019) 182046.  
 [3] M. Komar et al., *Molecules* 27 (2022) 558.  
 [4] B. B. Hensen et al, *Chem. Rev.* 121 (2021) 1232–1285.

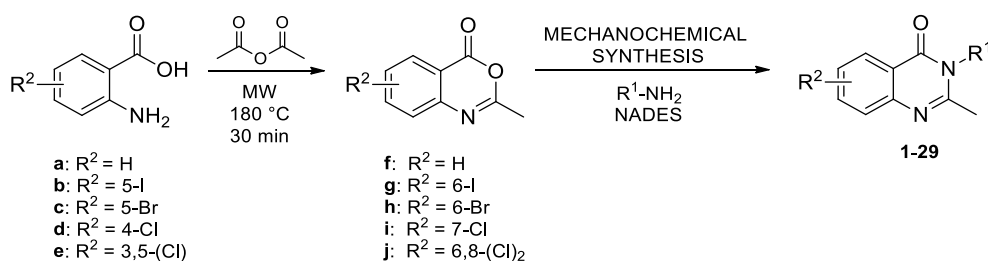

## SINTEZA NOVIH HIBRIDA BENZOKSAZOLONA I KUMARINA SYNTHESIS OF NEW BENZOXAZOLONE-COUMARIN HYBRIDS

**Petra Kovačec, Tatjana Gazivoda Kraljević**

University of Zagreb Faculty of Chemical Engineering and Technology, Trg Marka Marulića 19, 10000  
Zagreb, Croatia  
pkovacec@fkit.unizg.hr

Among the various privileged structures containing a heterocyclic ring that have been explored for the development of novel drug entities, benzoxazolone has an important role in medicinal chemistry since its derivatives possess anticancer, antiviral, antidepressant, anti-inflammatory, antioxidant and anti-HIV activities.[1] Besides, the coumarin ring is present in numerous compounds that show different biological activities derived from their substitution pattern and are used in medicinal chemistry.[2]

Herein, we have presented the synthesis of new N-substituted benzoxazolone derivatives containing variously substituted coumarin moiety bridged by ethoxy unit in order to evaluate their antitumor and antibacterial activity, 2-benzoxazolone was synthesized by cyclization reaction of 2-aminophenol using 1,1'-carbonyldiimidazole and subsequent N-alkylation reaction of the 2-benzoxazolone with dibromoethane in the presence of base gave N-bromoethyl-2-benzoxazolone. Targeted benzoxazolone-coumarin hybrids were prepared by substitution reaction of 7-hydroxycoumarin derivatives with N-bromoethyl-2-benzoxazolone. The structures of all newly prepared compounds were confirmed by <sup>1</sup>H- and <sup>13</sup>C-NMR spectroscopy.

- [1] H. Verma, O. Silakari, Key Heterocycle Cores for Designing Multitargeting Molecules 2018 (436) 343-367.  
[2] V. Flores-Moralec et al., Molecules 2023 (28) 2413.

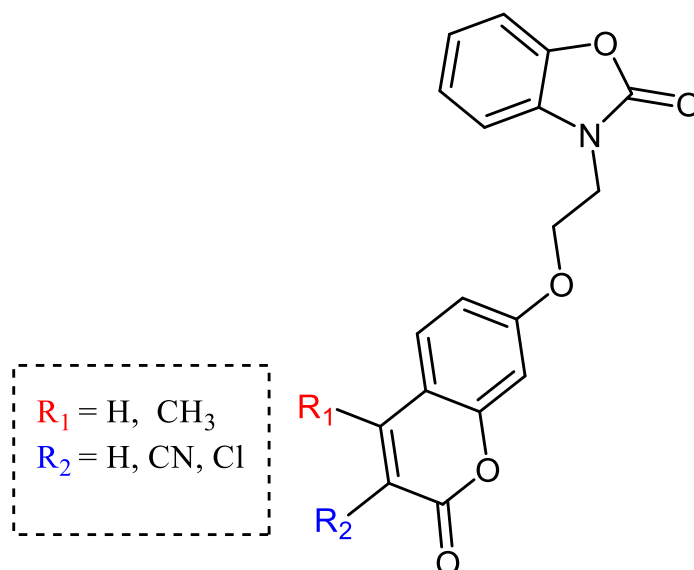

## KROMATOGRAFIJA ISKLJUČENJEM PO VELIČINI U PRISILNIM STUDIJAMA RAZGRADNJE BIOFARMACEUTIKA ADALIMUMABA

### SIZE EXCLUSION CHROMATOGRAPHY FOR FORCED DEGRADATION STUDIES OF BIOPHARMACEUTICAL ADALIMUMAB

**Jelena Kovačić<sup>1</sup>, Daniela Amidžić Klarić<sup>1</sup>, Nikša Turk<sup>2</sup>, Suzana Kucelj<sup>1</sup>, Ana Mornar<sup>1</sup>**

<sup>1</sup>Sveučilište u Zagrebu Farmaceutsko-biokemijski fakultet, Zavod za analitiku i kontrolu lijekova, Ul. Ante Kovačića 1, 10000 Zagreb, Hrvatska

<sup>2</sup>Klinički bolnički centar Zagreb, Zavod za gastroenterologiju, Kišpatićeva 12, 10000 Zagreb, Hrvatska  
suzana.kucelj17@gmail.com

Upalne bolesti crijeva, Crohnova bolest i ulcerozni kolitis spadaju u kronične, progresivne te relapsirajuće bolesti gastrointestinalnog trakta. Iako je njegova učestalost u globalnom porastu, točna etiologija ostaje nejasna, a smatra se da uključuje kombinaciju genetskih i okolišnih čimbenika što dovodi do neravnoteže između proupalnih i protuupalnih citokina u gastrointestinalnom traktu (GIT). Upotreba monoklonskih protutijela kao terapije temeljene na biološkim lijekovima u liječenju upalne bolesti crijeva je poboljšala ishode za pacijente. Adalimumab je prvi genetski modificirani, potpuno humanizirani imunoglobulin G1 (IgG1) monoklonsko antitijelo. Kromatografija isključenjem po veličini (engl. *Size exclusion chromatography*, SEC) postala je idealno rješenje za analizu bioloških lijekova u svom izvornom obliku. Naširoko se koristi u razvoju i proizvodnji za karakterizaciju bioterapeutskih molekula. Kod kromatografije isključenjem po veličini, molekule se odvajaju od najvećih do najmanjih u odnosu na njihovu veličinu molekula u otopini. U ovom istraživanju proveli smo studiju prisilne razgradnje adalimumaba i procijenili mogućnosti napredne SEC kolone napunjene česticama manjim od 3  $\mu\text{m}$  za razjašnjenje puta razgradnje. Rezultati su otkrili da su glavni produkti razgradnje adalimumaba fragmenti protutijela. Kiseli i bazni uvjeti su najintenzivnije djelovali na razgradnju adalimumaba dok lijek pokazuje relativnu stabilnost u uvjetima toplinskog i fotolitičkog stresa [1-3].

112

- [1] M. Atreva et al., Front Med. (2020) 517.  
[2] S. Fekete et al., J. Pharm. Biomed. Anal. (2014) 43-45.  
[3] R. Ratih et al., Microchem. J. (2021) 165.

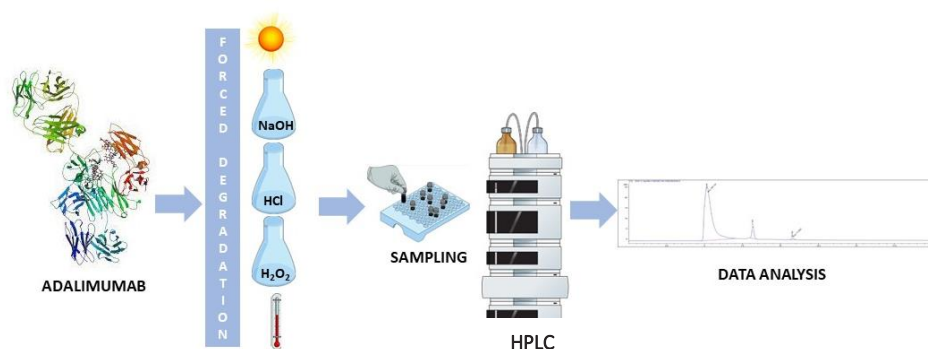

# PRIKLADNOST TEHNIKE UKLANJANJA FOSFOLIPIDA UZ LC-MS/MS ZA ODREĐIVANJE ABEMACIKLIBA I LETROZOLA U PLAZMI PACIJENTICA S RAKOM DOJKE – VALIDACIJA BIOANALITIČKE METODE

## SUITABILITY OF PHOSPHOLIPID REMOVAL WITH LC-MS/MS FOR DETERMINATION OF ABEMACICLIB AND LETROZOLE IN BREAST CANCER PATIENT PLASMA – BIOANALYTICAL METHOD VALIDATION

**Mateja Kuljanac, Lu Turković, Miranda Sertić**

Sveučilište u Zagrebu Farmaceutsko-biokemijski fakultet, Zavod za analitiku i kontrolu lijekova, Ul. Ante Kovačića 1, 10000 Zagreb, Hrvatska  
mkuljanac@student.pharma.hr

Abemaciclib je inhibitor kinaza 4 i 6 ovisnih o ciklinu (CDK4/6) registriran za liječenje lokalno uznapredovalog ili metastatskog raka dojke pozitivnog na hormonski receptor (HR) i negativnog na receptor humanog epidermalnog faktora rasta 2 (HER2). Koristi se u kombinaciji s inhibitorom aromataze (letrozol) ili antagonistom estrogena (fulvestrant) [1]. Noviji antitumorski lijekovi poput CDK4/6 inhibitora često su ciljanog djelovanja, ali usprkos tome postoje velike inter- i intraindividualne razlike u učinku i toksičnosti terapije. Iz tog razloga, više se istraživanja bavi proučavanjem pogodnih metoda za terapijsko praćenje novih antitumorskih lijekova [2]. Cilj ovog rada jest validirati bioanalitičku metodu za određivanje abemacicliba i letrozola u plazmi pacijenata. Uzorak za analizu sačinjen je od plazme obogaćene standardima abemacicliba i letrozola, a kao unutarnji standardi korišteni su deuterirani palbociclib i deuterirani anastrozol. Proteini iz uzorka istaloženi su acetonitriplom te je provedena filtracija na Agilent Captiva EMR-Lipid kolonici za uklanjanje fosfolipida. Nakon filtracije sorbens je ispran otopinom amonijaka u metanolu kako ne bi došlo do gubitka lipofilnijih analita. Filtrat je uparen i suhi ostatak otopljen u 65 %-tnom metanolu. Kromatografska analiza provedena je na Agilent 1260 sustavu, na Kinetex biphenyl koloni (150×4.6 mm, 2.6 μm). Mobilna faza sastojala se od faze A (voda i 0.1 %-tna mravlja kiselina) i faze B (acetonitril i 0.1 %-tna mravlja kiselina) uz brzinu protoka 0.5 mL/min. Za detekciju je korišten Ultivo Triple Quadrupole maseni spektrometar. Metoda je validirana u rasponu od 50 – 500 ng/mL za abemaciclib i 30 – 300 ng/mL za letrozol. Izračunate RSD vrijednosti za letrozol iznosile su 1.66 – 2.7 %, a za abemaciclib 2.79 – 4.81 %. Točnost, izražena kao analitički prinos, iznosi 97.24 – 103.49 % za letrozol te 90.80 – 113.62 % za abemaciclib. Ekstrakcijski prinos letrozola iznosio je 96.58 – 102.52 %, a abemacicliba 71.11 – 73.01 %. Svi su prethodno opisani rezultati validacije unutar referentnih vrijednosti te je to dokaz uspješne validacije. Primjenjivost metode dokazana je određivanjem koncentracije analita u plazmi stvarnih pacijenata.

113

- [1] Eli Lilly and Company (2022), Verzenio 100 mg film-coated tablets SmPC.  
[2] L. Turković et al, Farmaceutski glasnik 78 (2022) 551 – 565.

Istraživanje je u cijelosti financirano od strane Hrvatske zaklade za znanost kroz projekte UIP-2019-04-8461 i DOK-2021-02-4595 te od strane Europskog fonda za regionalni razvoj kroz projekt Farminova, KK.01.1.1.02.0021.

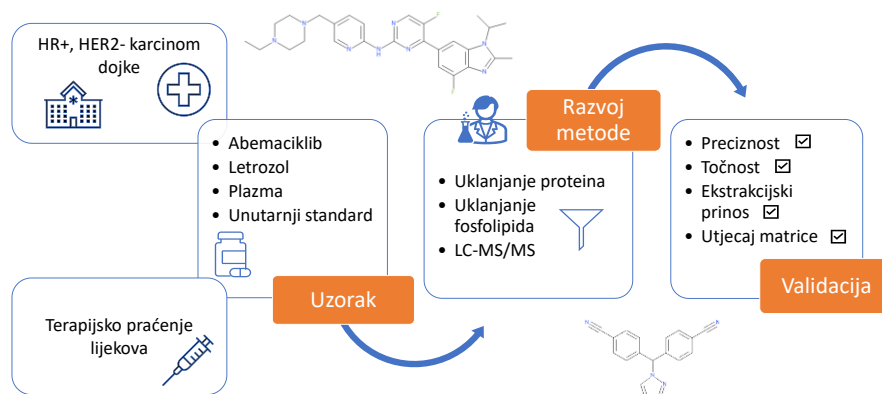

## UTJECAJ NATRIJEVOG HIPOKLORITA NA PRISUTNOST KSENOBIOTIKA U MODELNIM I REALNIM OTPADNIM VODAMA

### THE INFLUENCE OF SODIUM HYPOCHLORITE ON THE PRESENCE OF XENOBIOTICS IN MODEL AND REAL WASTEWATER

**Dora Lastovčić, Doris Stanić, Bruna Babić Visković, Danijela Ašperger**

Sveučilište u Zagrebu Fakultet kemijskog inženjerstva i tehnologije,  
Zavod za analitičku kemiju, Trg Marka Marulića 19, 10000 Zagreb, Hrvatska  
dlastovci@fkit.unizg.hr

Povećana upotreba antiparazitika u veterinarske i druge medicinske svrhe te široka primjena pesticida u poljoprivredi, dovode do kontinuiranog i nekontroliranog ispuštanja ksenobiotika u okoliš. Iako se oni i njihovi razgradni i transformacijski produkti u okolišu nalaze u tragovima, mogu uzrokovati dugoročno visoku koncentraciju tih onečišćivala i tako štetno djelovati na okoliš. Prije ili kasnije ti spojevi ispiranjem ili otjecanjem voda dospijevaju u vodeni okoliš i otpadne vode. Brojna istraživanja pokazuju da je uklanjanje mnogih ksenobiotika u konvencionalnim uređajima za obradu otpadnih voda često nepotpuno te stoga dolazi do onečišćenja prirodnih vodotoka. Poznato je da sredstva za dezinfekciju također uklanjaju i organska onečišćenja stoga je cilj ovoga rada procijeniti utjecaj prisutnosti natrijevog hipoklorita kao dezinfekcijskog sredstva na uklanjanje ksenobiotika u otpadnim vodama nakon postupka šaržne biorazgradnje kao konvencionalne i često primjenjivane metode. [1-3]

Provodio se proces biorazgradnje u tri aerirana šaržna reaktora različitih sadržaja. Prvi reaktor je sadržavao aktivni mulj i radnu otopinu ksenobiotika masene koncentracije  $10 \text{ mg L}^{-1}$ . Kao kontrolni reaktor, drugi reaktor je sadržavao samo aktivni mulj, dok je treći reaktor sadržavao samo radnu otopinu ispitivanog ksenobiotika iste koncentracije. Uz ispitivanje fizikalno-kemijskih parametara biorazgradnje, praćena je koncentracija u vremenskim razmacima uzorkovanja. Nakon procesa biorazgradnje, otopine ksenobiotika podvrgnute su procesu fotolize kao obliku tercijarne obrade otpadnih voda. Fotoliza se provodila u četiri kvarcne posudice s različitim sadržajem. Tijekom procesa fotolize ispitivan je utjecaj prisutnosti natrijevog hipoklorita na uklanjanje ksenobiotika uz usporedno provođenje uklanjanja ksenobiotika s vodikovim peroksidom kao vrlo učinkovitom metodom. Rezultati su pokazali različitu učinkovitost uklanjanja šest ispitivanih ksenobiotika. Novonastali razgradni i/ili transformacijski produkti detektirani su tekućinskom kromatografijom visoke djelotvornosti s detektorom s nizom dioda. Također, procijenjena je toksičnost istraživanih otopina ksenobiotika pomoću bioluminiscentne metode određivanja akutne toksičnosti bakterijom *Vibrio fischeri*.

- [1] L. Charuaud et al., J. Hazard. Mater. 361 (2019) 169–186.
- [2] J. Wilkinson et al., Appl. Sci. 9 (2019) 2997-2998.
- [3] S. Fetzner, Biotechnology 10 (2002) 1-8.
- [4] B. Babić Visković et. al., Processes 11 (2023) 3403-3422.

Ovaj rad izrađen je u sklopu projekta „Water reuse and membrane separation processes for reliable and sustainable water supply“ (WaRMem) na Sveučilištu u Zagrebu Fakulteta kemijskog inženjerstva i tehnologije.

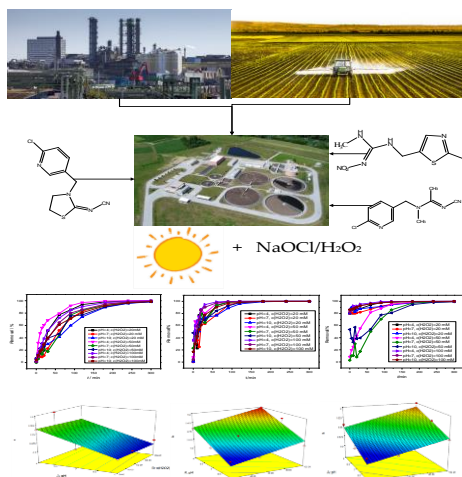

## TERAPIJSKO PRAĆENJE LIJEKOVA ZA RAK DOJKE: VALIDACIJA METODE ZA ODREĐIVANJE PALBOCIKLIBA I FULVESTRANTA U LJUDSKOJ PLAZMI PRIMJENOM TEHNIKE EKSTRAKCIJE NA ČVRSTOJ FAZI UZ LC-MS/MS

### THERAPEUTIC DRUG MONITORING OF BREAST CANCER DRUGS: VALIDATION OF A METHOD FOR THE DETERMINATION OF PALBOCICLIB AND FULVESTRANT IN HUMAN PLASMA USING SOLID-PHASE EXTRACTION WITH LC-MS/MS

**Hana Librenjak, Lu Turković, Miranda Sertić**

Sveučilište u Zagrebu Farmaceutsko-biokemijski fakultet, Zavod za analitiku i kontrolu lijekova, Ul. Ante Kovačića 1  
10000 Zagreb, Hrvatska  
hlibrenjak@pharma.hr

Boljim upoznavanjem biologije svih tumora, posljednjih godina došlo je do razvoja inovativnih i ciljanih lijekova u terapiji karcinoma dojke. [1] Jedna od skupina lijekova su inhibitori kinaza ovisnih o ciklinima – CDK4/6 (engl. cyclin-dependent kinase 4/6), palbociklib, ribociklib i abemaciklib. Lijekovi iz ove skupine upotrebljavaju se u kombinaciji s endokrinom terapijom, odnosno inhibitorima aromataze, letrozolom i anastrozolom, ili kompetitivnim antagonistom estrogenskih receptora, fulvestrantom. Uska terapijska širina i interindividualne razlike u farmakokinetici ovih lijekova dovode do potrebe za razvojem bioanalitičkih metoda koje bi omogućavale terapijsko praćenje njihovih koncentracija. [2] Nakon razvoja bioanalitičke metode, istu je potrebno validirati kako bi se utvrdila i dokumentirala prikladnost metode za redovnu primjenu [3,4]. U ovome radu validirana je metoda određivanja lijekova palbocikliba i fulvestranta, izražavanjem linearnosti, točnosti, preciznosti, ekstrakcijskog prinosa i utjecaja matrice.

Validacija je, sukladno smjernicama, provedena na uzorcima plazme zdravih dobrovoljaca obogaćenih poznatim koncentracijama analita od interesa. U ovom radu korištena je ekstrakcija na čvrstoj fazi pomoću Oasis Sep-Pak C8 200 mg x 3 mL sorbensa. Kao unutarnji standard koristili su se deuterirani analiti, palbociklib-d4 i fulvestrant-d3. Analiza se provodila na uređaju Agilent 1260 Infinity spregnutom s Agilent Ultivo masenim spektrometrom s analizatorom trostrukog kvadrupola. Separacija je provedena na Kinetex biphenyl koloni (2.6 µm, 150×4.6 mm), uz primjenu binarne gradijentne elucije, (eluens A: voda i 0.1 % mravlje kiseline, eluens B: acetonitril i 0.1 % mravlje kiseline).

Metoda je validirana u rasponu 30 – 300 ng/mL za palbociklib i 10 – 100 ng/mL za fulvestrant. Unutar koncentracijskog raspona dokazana je linearnost ( $R > 0.9993$ ) preciznost ( $RSD < 1.85$ ) i točnost (analitički prinos  $> 89.6\%$ ). Ekstrakcijski prinos za palbociklib veći je od 91.17 %, dok je za fulvestrant veći od 69.43 %. Utjecaj matrice za palbociklib je 110.25 % i 106.92 %, pri nižoj i višoj izmjerenoj koncentraciji, a za fulvestrant iznosi 88.01 % i 90.78 %. Izmjerene vrijednosti utjecaja matrice unutar su prihvatljivih raspona za oba analita, što dovodi do zaključka da sastavnice matrice nemaju značajan utjecaj na detekciju analita odabranom metodom. Naposljetku, kako bi se pokazala primjenjivost metode, određene su koncentracije palbocikliba i fulvestranta u uzorcima plazme stvarnih pacijenata.

[1] M. Ban et al., *Liječ Vjesn.* 141 (2019) 33–39.

[2] L. Turkovic et al., *Pharmaceuticals* 15 (2022) 614.

[3] ICH guideline M10 on bioanalytical method validation and study sample analysis EMA/CHMP/ICH/172948/2019

[4] B. Nigović et al., *Analitika lijekova – Praktikum*, Sveučilište u Zagrebu Farmaceutsko-biokemijski fakultet, 2022., str. 128.

Ovaj rad je u potpunosti financiran od strane Hrvatske zaklade za znanost kroz projekte UIP-2019-04-8461 i DOK 2021-02-4595, i Europskog fonda za regionalni razvoj kroz projekt Farminova, KK.01.1.1.02.0021.



## UTJECAJ IZVORA ONEČIŠĆENJA ZRAKA NA KONCENTRACIJU PM<sub>1</sub> U KUĆANSTVIMA

### INFLUENCE OF AIR POLLUTION SOURCES ON PM<sub>1</sub> CONCENTRATION IN HOUSEHOLDS

**Marija Jelena Lovrić Štefiček<sup>1</sup>, Silvije Davila<sup>1</sup>, Gordana Pehneć<sup>1</sup>, Goran Gajski<sup>1</sup>, Ivan Bešlić<sup>1</sup>, Iva Smoljo<sup>1</sup>, Luka Delić<sup>1</sup>, Mirjana Turkalj<sup>2</sup>, Ivana Banić<sup>2</sup>**

<sup>1</sup>Institut za medicinska istraživanja i medicinu rada, Ksaverska cesta 2, 10000 Zagreb, Hrvatska

<sup>2</sup>Dječja bolnica Srebrnjak, Srebrnjak 100, 10000 Zagreb, Hrvatska  
mlovric@imi.hr

Utjecaj pojedinih izvora onečišćenja na koncentracije onečišćujućih tvari u zraku unutarnjih prostora jedna je od glavnih tema u proučavanju okoliša i zdravlja. Prijašnja istraživanja su pokazala da ljudi koji žive uz prometnice imaju veću vjerojatnost da će pretrpjeti štetne zdravstvene učinke [1]. Budući da ljudi većinu vremena provode u zatvorenim prostorima kod kuće, očekuje se da će izvori onečišćujućih tvari u zatvorenom prostoru, poput grijanja, kuhanja, duhanskog dima i sl. doprinijeti njihovim koncentracijama. Postoji više izvora u zatvorenom prostoru koji pridonose onečišćenju zraka. Unutarnje koncentracije ultrafinih čestica (UFP) (čestica s aerodinamičkim promjerom od 100 nm ili manje) mogu biti povišene do 5 puta zbog aktivnosti povezanih s kuhanjem [2]. Ljudi koji u kućanstvu koriste plinske štednjake imaju više respiratornih problema za razliku od ljudi koji koriste električne štednjake [3].

U okviru projekta EDIAQI (Evidence Driven Indoor Air Quality Improvement) provodi se u Zagrebu pilot istraživanje kvalitete zraka u kućanstvima. U sklopu istraživanja određuju se koncentracije lebdećih čestica aerodinamičkog promjera manjeg od 1 μm (PM<sub>1</sub>). Cilj ovog rada je na temelju preliminarnih rezultata istražiti povezanosti parametara koji opisuju tip kućanstva, potencijalne izvore onečišćivača zraka u zatvorenom prostoru, te blizinu prometnice kao vanjskog izvora na koncentraciju frakcije lebdećih čestica PM<sub>1</sub>.

Analiza podataka je napravljena korištenjem Python knjižnica. Prvi rezultati na dijelu podataka pokazali su između ostalog utjecaj broja i površine tepiha u kućanstvu na koncentraciju PM<sub>1</sub>. Svi rezultati u ovom radu dio su preliminarnog testiranja, a daljnja istraživanja će se provoditi kroz EDIAQI projekt.

[1] N.J. Hime et al., Int. J. Environ. Res. Public. Health 15 (2018) 1206.

[2] C. He et al., Atmos. Environ. 38 (2004) 3405–3415.

[3] D. Jarvis et al., The Lancet 347 (1996) 426–431.

Rezultati su proizašli iz rada na opremi nabavljenoj u sklopu projekta KK.01.1.1.02.0007 "Istraživačko-edukacijski centar za zdravstvenu i medicinsku ekologiju i zaštitu od zračenja - rekonstrukcija i dogradnja Instituta za medicinska istraživanja i medicinu rada" te rada u sklopu Obzor Europa EDIAQI projekta (Evidence Driven Indoor Air Quality Improvement, #101057497).

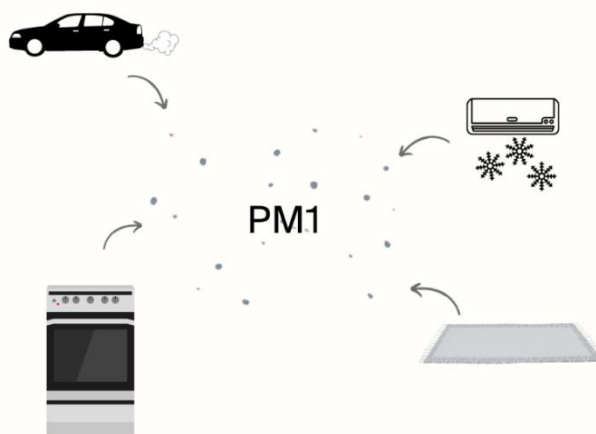

## ADSORPCIJA POLI(4-STIRENSULFONATA) NA KOLOIDNE NANO-ČESTICE KALCIJEVA FLUORIDA

## ADSORPTION OF POLY(4-STYRENESULFONATE) ON COLLOIDAL NANO-PARTICLES OF CALCIUM FLUORIDE

**Filip Margetić, Juraj Nikolić, Tajana Begović**

Sveučilište u Zagrebu Prirodoslovno-matematički fakultet, Kemijski odsjek, Horvatovac 102a, 10000 Zagreb, Hrvatska  
 filip.margetic@chem.pmf.hr

Adsorpcija polielektrolita na koloidne čestice važan je dio raznih industrijskih i tehnoloških procesa. Koloidne čestice kalcijeva fluorida ( $\text{CaF}_2$ ) pokazale su se kao izvrstan izbor za široku primjenu u dentalnoj i općoj medicini zbog svojih antibakterijskih svojstava [1]. Polielektroliti su duge, lančaste makromolekule čije monomerne jedinice sadrže ionizabilne skupine zbog čega uvjeti sustava mogu utjecati na naboj molekula adsorbiranih na površini koloida. Polielektroliti poput poli(natrijeva 4-stirensulfonata) (PSS) koriste se u procesima pročišćavanja otpadnih voda u kojima dolazi do adsorpcije na površinu ili kompleksiranja sa širokim rasponom kationa metala poput  $\text{Ca}^{2+}$  [2]. Ispitivanjem adsorpcije polielektrolita na koloidne čestice određene veličine može se aproksimirati određenim adsorpcijski modelom kojim opisujemo fizikalne procese koji su bitni za primjenu takvog materijala. U ovom istraživanju praćena je adsorpcija PSS-a na koloidne čestice  $\text{CaF}_2$  u kontroliranim uvjetima ionske jakosti, pH i temperature direktno nakon adsorpcije, te nakon sedam dana. Količina adsorbiranog polielektrolita i ravnoteža adsorpcije praćena je UV-VIS spektrofotometrijom dok je veličina čestica nakon adsorpcije određena metodom dinamičkog raspršenja svjetlosti (DLS). Istovremeno uz DLS mjerenja, mjerenjem zeta-potencijala određen je naboj adsorbiranih čestica. Također, ispitana je i provodnost otopine PSS-a s koloidnim česticama  $\text{CaF}_2$  metodom konduktometrijske titracije.

- [1] W. A. Bala et al., J. Fluor. Chem. 193 (2017) 38-44  
 [2] M. Chen et al., Chem. Eng. J. 344 (2018) 155-164

Istraživanje je napravljeno u sklopu projekta Hrvatske zaklade za znanost „Fizikalna kemija procesa na međupovršini mineral/otopina (poli)elektrolita“ (IP-2020-02-9571).

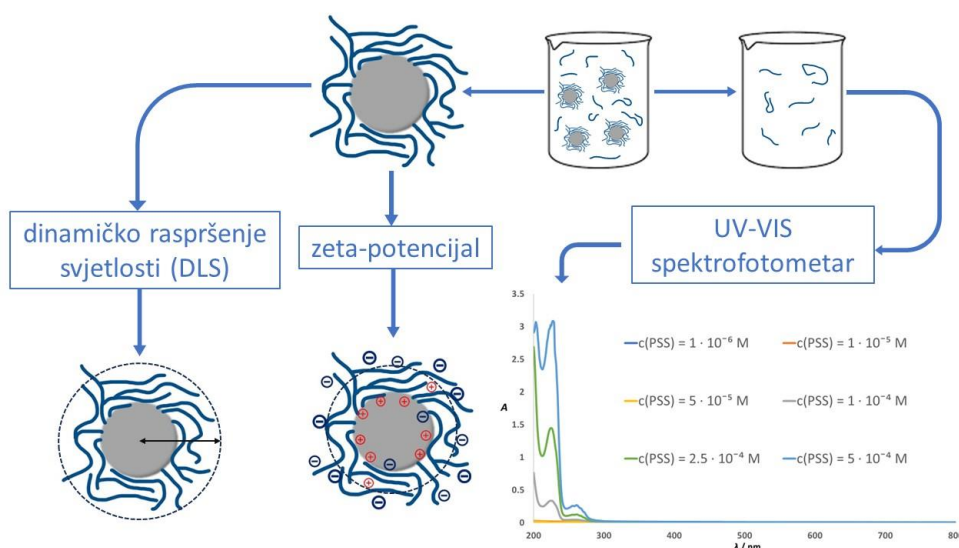

# ADSORPTION OF HESPERIDIN FROM ORANGE PEEL AND PULP ONTO $\beta$ -GLUCAN FROM BARLEY

**Petra Matić, Stela Juriša, Lidija Jakobek**

Josip Juraj Strossmayer University of Osijek, Faculty of Food Technology Osijek, Franje Kuhača 18, 31000 Osijek, Croatia  
petra.matic@ptfos.hr

Oranges are a rich source of flavanones, especially hesperidin which can be found in high amount in orange peel. Flavanones showed some potentially positive bioactivities like interactions with dietary fiber. One of the natural dietary fibers which can be found in barley is  $\beta$ -glucan. Interactions between hesperidin and  $\beta$ -glucan can be studied through the adsorption process and different adsorption models can be applied. The aim of this work was to study interactions between hesperidin from orange peel and pulp and dietary fiber ( $\beta$ -glucan). Hesperidin was extracted from orange peel and pulp with 80% methanol by the ultrasound extraction. Extracts were filtered through a PTFE syringe filter with 0.2  $\mu$ m pores and then analyzed on the HPLC system to determine the content of hesperidin in extracts. Adsorption was performed with orange peel and pulp extracts at pH 7.0 and 37°C. After the adsorption process unadsorbed hesperidin was determined with HPLC method. Langmuir, Dubinin-Radushkevich and Hill model was applied. FTIR spectrum was recorded for identify the functional groups in the adsorption process between hesperidin and  $\beta$ -glucan. The results showed that adsorption capacity of hesperidin from orange peel was 165 mg/g, and from orange pulp 120 mg/g. Adsorption was affected by the concentration of hesperidin and  $\beta$ -glucan in reaction solution. FTIR spectrum indicate the intramolecular bonding between hesperidin and  $\beta$ -glucan like hydrogen bonds. These results may contribute to a better understanding of the adsorption of hesperidin onto  $\beta$ -glucan. Also, this study can contribute for possible design of functional food, or to increase bioaccessibility of hesperidin in the lower parts of the gastrointestinal tract.

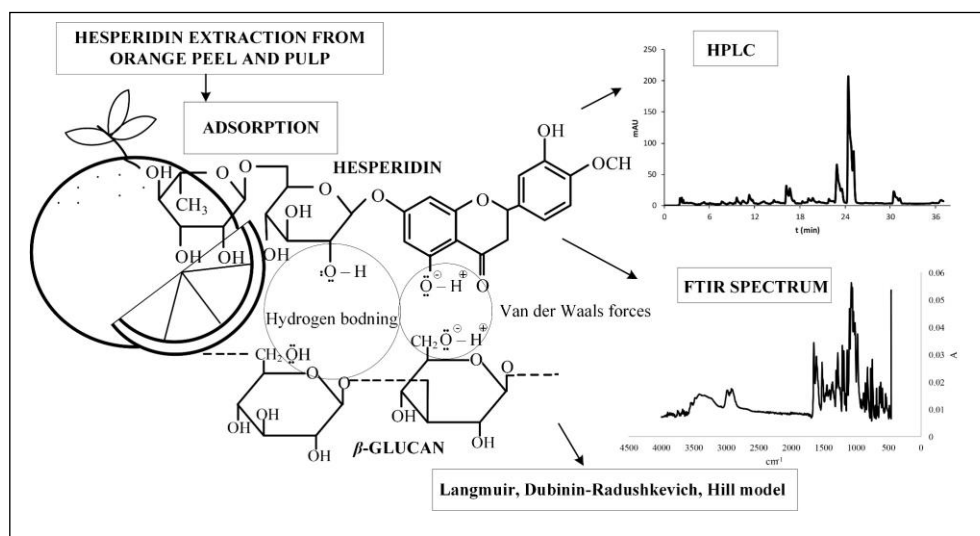

## ELEMENTNA ANALIZA SUŠENOG MANGA SPEKTROMETRIJOM MASA UZ INDUKTIVNO SPREGNUTU PLAZMU

## ELEMENTAL ANALYSIS OF DRY MANGO BY INDUCTIVELY COUPLED PLASMA MASS SPECTROMETRY

**Emu Mihalić<sup>1</sup>, Iva Juranović Cindrić<sup>1</sup>, Ivan Nemet<sup>1</sup>, Michaela Zeiner<sup>2</sup>,  
Heidelore Fiedler<sup>2</sup>**

<sup>1</sup>Sveučilište u Zagrebu Prirodoslovno-matematički fakultet, Kemijski odsjek, Zavod za analitičku kemiju, Horvatovac  
102a, 10000 Zagreb, Hrvatska

<sup>2</sup>Örebro University, School of Science and Technology, Man-Technology-Environment Research Centre, 5  
Fakultetsgatan 1, 70182, Örebro, Sweden  
emihalic@chem.pmf.hr

Mango (*Mangifera indica*, L.) je vrlo popularno tropsko citrusno voće koje se može konzumirati svježe ili kao suho voće. Bogat je esencijalnim nutrijentima poput vitamina, dijetalnih vlakana i minerala, te biološki aktivnim tvarima koje nemaju nutritivnu vrijednost, ali pozitivno utječu na zdravlje. Sušeni mango odličan je izvor esencijalnih elemenata, no isto tako može sadržavati i potencijalno toksične elemente [1], [2]. Analizirani su komercijalno dostupni uzorci sušenog manga te mezokart i kora svježeg manga koji su osušeni prije analize. Prije multielementne analize metodom spektrometrije masa uz induktivno spregnutu plazmu (ICP-MS) optimizirana je metoda pripreme uzorka različitim reagensima u uređaju za mikrovalno potpomognutu razgradnju. Dobiveni rezultati obrađeni su kemometrijskim metodama. Uspoređen je sadržaj elemenata u kori i mezokartu svježeg manga. U najvećoj udjelu određeni su makroelementi Ca, K, Mg i Na koji su važni za čovjekovo zdravlje, a mikroelementi prisutni u značajnijim količinama su Cu, Zn te Mn ( $> 3 \text{ mg kg}^{-1}$ ), dok toksični elementi nisu pronađeni u udjelima iznad dopuštenih koji bi prema smjernicama EFSA (eng. *The European Food Safety Authority*) predstavljale opasnost za ljudsko zdravlje [3].

- [1] B. Mirza et al., *Crit. Rev. Food Sci. Nutr.* 61 (2021) 2125-2151.  
[2] S. K. Chang et al., *J. Funct. Foods* 21 (2016) 113-132.  
[3] EFSA Panel on Nutrition, *EFSA J.* 20 (2022) e200102.

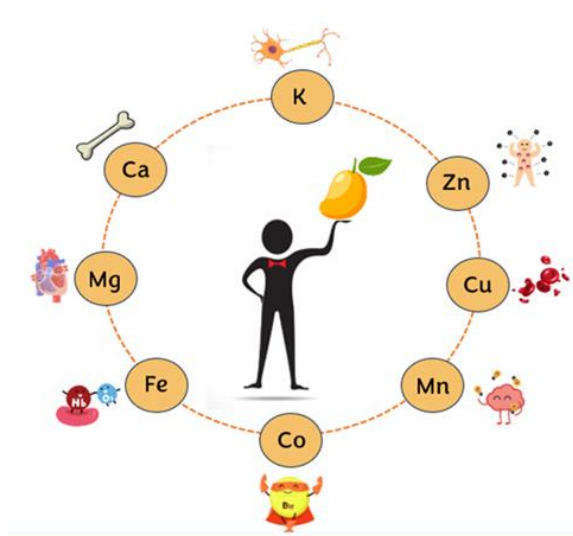

Esencijalni elementi prisutni u mangu (*Mangifera indica*, L.) i njihov utjecaj na ljudski organizam.

## NOVEL 1,2,3-TRIAZOLE DERIVATIVES OF BENZOXAZOLE: CONVENTIONAL AND GREEN SYNTHESIS

**Robert Ostrički<sup>1</sup>, Anja Rakas<sup>2</sup>, Tatjana Gazivoda Kraljević<sup>2</sup>**

<sup>1</sup>Porton Pharmatech d.o.o, Kolodvorska cesta 27, 1234 Mengeš, Slovenia

<sup>2</sup>University of Zagreb Faculty of Chemical Engineering and Technology, Trg Marka Marulića 19, 10000 Zagreb, Croatia

arakas@fkit.unizg.hr

Benzoxazoles are bioisosteres of natural nucleotides and exhibit exceptional pharmacological activities such as anticancer, antibacterial and antiviral. In addition, some of them have found application as fluorescent whitening agents and functional materials. Benzoxazole derivatives have gained a lot of importance in the past few years due to their use in intermediates for the preparation of new biological materials. Additionally, a 1,2,3-triazole core provides diverse pharmacophore properties, and hybrids are most commonly considered lead compounds when they contain or are fused by a 1,2,3-triazole ring [1]. Green chemistry focuses on designing products and processes that minimize the generation or use of hazardous substances applying green solvents, microwave and ultrasonic radiation, and a solvent-free approach [2]. Within the pharmaceutical industry, solvents represent around 80 % of the generated waste. Because of that, the selection, recycling and adequate treatment of solvents is crucial for minimizing the negative impact on the environment. Natural deep eutectic solvents (NADES) represent a novel class of solvents which consist of biodegradable, non-toxic and readily available components linked with a complex network of hydrogen bonds (e.g. choline chloride, ethylene glycol) [3]. Considering the aforementioned factors and the recent research focus, this paper describes synthesis of novel benzoxazole derivatives containing 1,2,3-triazole ring utilizing conventional and green synthetic methods such as ultrasonic and microwave-assisted synthesis, mechanochemical synthesis, and synthesis in deep eutectic solvent. 1,2,3-triazole derivatives of benzoxazole were prepared *via* the copper-catalyzed azide-alkyne cycloaddition reaction (CuAAC) of propargylated benzoxazoles with corresponding azides utilizing both conventional solvents (*t*-BuOH/water) and NADES. Structures of novel 1,2,3-triazole derivatives of benzoxazole were confirmed by <sup>1</sup>H and <sup>13</sup>C NMR spectroscopy and mass spectrometry as well.

120

- [1] H. Elkady et al., J. Enzyme Inhib. Med. Chem. 37 (2022) 397-410.  
 [2] R. Sttar et al., J. Heterocyclic. Chem. 57 (2020) 2079-2107.  
 [3] S. E. Hooshmand et al., Green Chem. 22 (2020) 3668-3692.

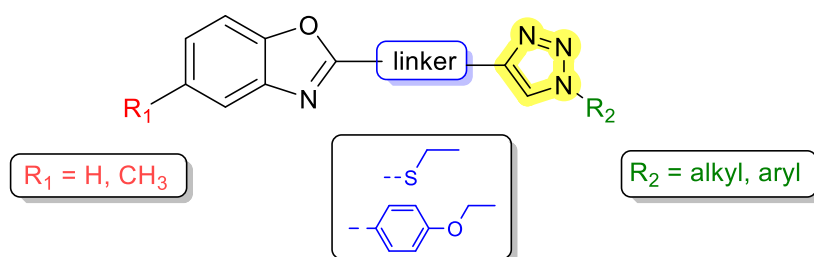

## SINTEZA D-GLUKOZNIH I N-ACETIL-D-GLUKOZAMINSKIH DERIVATA FEROCENA

## SYNTHESIS OF D-GLUCOSE AND N-ACETYL-D-GLUCOSAMINE DERIVATIVES OF FERROCENE

**Franko Pahović, Srećko I. Kirin, Đani Škalamera**

University of Zagreb Faculty of Science, Department of Chemistry, Horvatovac 102a, 10000 Zagreb, Croatia  
fpahovic@chem.pmf.hr

Among all organometallic compounds containing ferrocene moieties, ferrocene peptides are, by far, the most interesting class. This type of compounds stands out due to their helical chirality. This type of optical activity is caused by the stabilization of the rotamers due to the presence of intramolecular hydrogen bonds between the peptide chains attached to both cyclopentadienyl rings (Fig. 1a) [1]. Ferrocene is indeed an ideal model for enantioselective catalysts because of the appropriate distance between the cyclopentadienyl rings and the potential to induce helical chirality [2,3]. To date, no analogs of ferrocene peptides have been described in the literature in which supramolecular interactions are realized between saccharide units instead of between peptide chains. Since sugars are compounds with well-defined chirality and have many polar hydroxyl groups that can be both hydrogen bond donors and acceptors, there is a chance that chirality would also be transferred to ferrocene unit through non-bonding interactions. In this study, the synthesis of mono and disubstituted conjugates of D-glucose and N-acetyl-D-glucosamine was performed using ferrocene monocarboxylic acid and ferrocene 1,1'-dicarboxylic acid (Fig 1b). Ethylene bridge was installed between ferrocene and the sugar component of the molecule to ensure flexibility of the entire structure and thus allow the formation of stronger hydrogen bonds between the sugar units. To synthesize D-glucose derivatives, peracetylated D-glucose was glycosylated via direct method using 2-bromoethanol as a glycosyl acceptor. In the case of N-acetyl-D-glucosamine conjugate, the synthesis was performed by glycosylation of the corresponding oxazoline intermediate with 2-bromoethanol. In order to facilitate condensation with ferrocene (di)carboxylic acid, the resulting bromides were substituted with an azide, which was subsequently reduced to an amine.

121

- [1] S. I. Kirin, H.-B. Kraatz, N. Metzler-Nolte Chem. Soc. Rev. 35 (2006) 348–354.  
[2] N. Pantalon Juraj, S. I. Kirin Coord. Chem. Rev. 445 (2021) 214051.  
[3] J. F. Scholtes, O. Trapp Angew. Chem. Int. Ed. 58 (2019) 6306–6310.

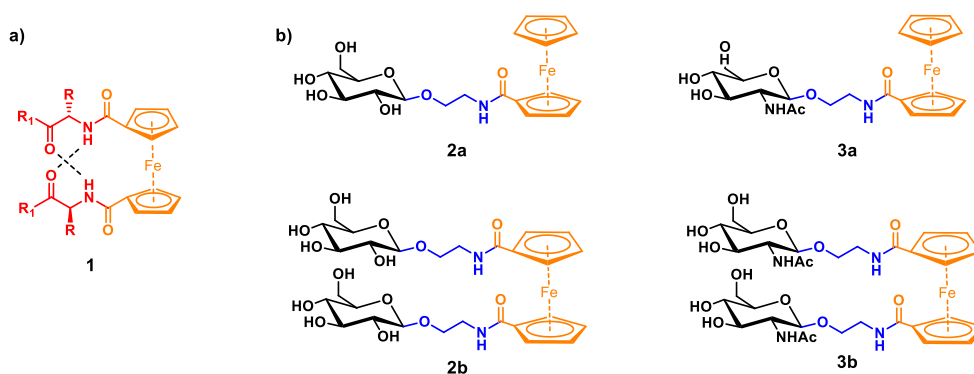

Hydrogen bond pattern in the structure of ferrocene peptides. [1]  
b) Structures of the target molecules.

## OPTIMIZACIJA EKSTRAKCIJE INHIBITORA CDK4/6 IZ UZORAKA TKIVA PLUĆA ŠTAKORA ZA LC-MS/MS ANALIZU

### OPTIMISATION OF EXTRACTION OF CDK4/6 INHIBITORS FROM RAT LUNG TISSUE SAMPLES FOR LC-MS/MS ANALYSIS

Lu Turković<sup>1</sup>, Martina Papić<sup>1</sup>, Zvonimir Mlinarić<sup>1</sup>, Slaven Crnković<sup>2,3,4</sup>,  
Miranda Sertić<sup>1</sup>

<sup>1</sup>Sveučilište u Zagrebu Farmaceutsko-biokemijski fakultet, Zavod za analitiku i kontrolu lijekova, Ante Kovačića 1, 10 000 Zagreb, Hrvatska

<sup>2</sup>Division of Physiology, Otto Loewi Research Center, Medical University of Graz, Neue Stiftingtalstraße 6, 8010 Graz, Austria

<sup>3</sup>Ludwig Boltzmann Institute for Lung Vascular Research, 8010 Graz, Austria

<sup>4</sup>Institute for Lung Health, Justus Liebig University, Aulweg 130, 35392 Giessen, Germany  
mpapic@student.pharma.hr

Inhibitori o ciklinu ovisnih kinaza 4 i 6 (CDK4/6) palbociklib, ribociklib i abemaciclib su antitumorski lijekovi koji zaustavljaju stanični ciklus sprječavanjem progresije iz G1 u S fazu. Trenutno su registrirani za liječenje hormon-ovisnog raka dojke, ali u tijeku su i brojne pretkliničke i kliničke studije koje ispituju njihovu učinkovitost kod drugih tipova raka, poput gastrointestinalnog tumora, hepatocelularnog karcinoma, karcinoma pluća ne-malih stanica i drugih [1]. U ovom radu optimizirana je ekstrakcija palbocikliba, ribocikliba i abemacicliba iz uzorka pluća štakora primjenom taloženja proteina (engl. *protein precipitation*, PPT) acetonitrilom, tekućinske disperzivne mikroekstrakcije (engl. *dispersive liquid-liquid microextraction*, DLLME) smjesom *i*-propanola i kloroforma, ekstrakcije na čvrstoj fazi (engl. *solid-phase extraction*, SPE) oktadecilsililnim sorbensom (C18), sorbensom hidrofilno-lipofilnog balansa (HLB) te kationskim izmjenjivačem miješanog tipa (MCX), kao i sorbensa za uklanjanje fosfolipida (engl. *phospholipid removal*, PLR). Homogenizacija je provedena pomoću tarionika na hladnom. Uzorci su suspendirani u acetonitrilu ili vodi (1 mL otapala po 1 mg tkiva) uz vorteksiranje. Acetonitrilni supernatant korišten je za provođenje dodatnih koraka pročišćavanja DLLME-om i PLR-om ili je uparen do suha i analiziran kako bi se utvrdila učinkovitost ekstrakcije taloženjem proteina. Vodeni supernatant je korišten za provedbu SPE-a. Analiza je provedena na Agilent 1260 Infinity HPLC uređaju s Agilent Ultivo masenim spektrometrom trostrukog kvadrupola, uz Phenomenex Kinetex biphenyl kolonu (150×4,6 mm, 2,6 μm) i mobilnu fazu sastavljenu od vode i acetonitrila s dodatkom 0,1 % mravlje kiseline u gradijentnom ispiranju. Detekcija je provedena uz praćenje masenih prijelaza analita i odabranih fosfolipida kao indikatora učinkovitosti pročišćavanja uzorka ( $m/z$  496,0→184,0 i 524,0→184,0). Fosfolipidi su zastupljeni u većoj mjeri u biološkim uzorcima, a mogu ometati detekciju i smanjiti vijek trajanja analitičkog instrumenta stoga ih je kroz postupak pripreme uzorka poželjno ukloniti. Visoki ekstrakcijski prinosi postignuti su uz PPT i DLLME (>86,8 %), ali uz uočljive pikove fosfolipida. Niži prinosi postignuti su primjenom PLR, pogotovo za abemaciclib, dok je uz MCX sorbens uočena smanjena ponovljivost. Kao najbolji postupak pripreme uzorka, uz učinkovito pročišćavanje (utjecaj matriksa <16,4 %) i visoke prinose ekstrakcije svih analita iz tkiva štakora (>80,9 %) pokazala se SPE primjenom HLB i C18 sorbensa.

122

[1] M. E. Klein et al., *Cancer Cell*. 34 (2018) 9-20.

Ovo istraživanje je financirano sredstvima projekta Nova bioanalitička rješenja za personalizaciju terapije raka dojke (UIP-2019-04-8461) Hrvatske zaklade za znanost i sufinanciran sredstvima Europske unije iz Europskog fonda za regionalni razvoj projektom FarmInova (KK.01.1.1.02.0021).

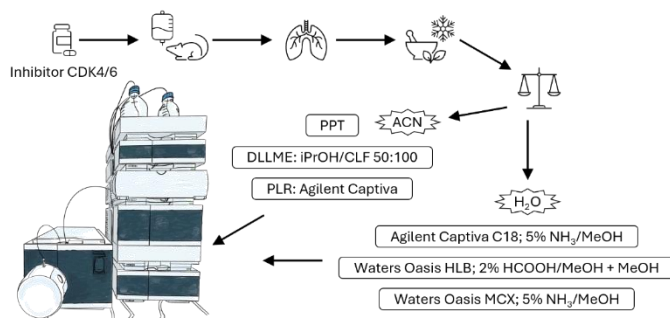

# INFLUENCE OF SODIUM SACCHARINATE AND POTASSIUM ACESULFAME AS AN ADDITIVE ON STRUCTURAL ORGANIZATION AND CAFFEINE SOLUBILITY IN WATER

**Dario Piuković, Andrija Vukov, Teona Teodora Borović, Milan Vraneš**

University of Novi Sad, Faculty of Sciences, Department of Chemistry, Biochemistry and Environmental Protection,  
Novi Sad, 21000, Republic of Serbia  
piukovicd@gmail.com

Caffeine is a commonly consumed psychoactive substance belonging to the purine alkaloid group. It can be found in various beverages including coffee, black and green tea, soft and energy drinks, various medicines and cosmetic products [1]. Caffeine solubility in water is relatively low, approximately  $16 \text{ mg}\cdot\text{mL}^{-1}$  at room temperature, which is one of the crucial problems, especially in preparations consumed or stored at low temperatures, such as some drinks [2]. Moreover, caffeine has a slightly bitter taste. Caffeine is considered limitedly soluble in water due to the self-association and aggregation of caffeine molecules by hydrophobic interactions [3]. The solution for increasing solubility and limiting aggregation is to add biocompatible additives. Our research aims to determine caffeine solubility in water and the structural organization of its molecules in the presence of selected additives suitable for wide use in the pharmaceutical and food industries.

Intense sweeteners like sodium saccharin (Na-Sah) and potassium acesulfame (Ace-K) are extensively used due to effectively non-caloric and tooth-friendly behavior. They represent a suitable substitute for sugar, while avoiding the negative effects associated with sugar intake into the body.

The present study analyzed experimental data from solubility, volumetric measurements and computational data simulations to understand caffeine hydration and aggregation properties in  $0.1 \text{ mol}\cdot\text{kg}^{-1}$  of sodium saccharinate and potassium acesulfame aqueous solution in the temperature range from 293.15 to 313.15 K. The density results obtained in volumetric measurements were used to see the effect of Na-Sah and Ace-K on the taste behavior of caffeine, which has been discussed from volumetric parameters. In  $0.1 \text{ mol}\cdot\text{kg}^{-1}$  Na-Sah aqueous solutions, caffeine had a 1.51 – 2 times higher solubility, while in a  $0.1 \text{ mol}\cdot\text{kg}^{-1}$  Ace-K aqueous solutions, caffeine had a 1.22 – 1.55 times higher solubility than caffeine in pure water, depending on the temperature.

123

- [1] D. P. Evatt, R. R. Griffiths, Encyclopedia of Human Nutrition, 2013, 221- 227.  
[2] S. J. Oestreich, Encyclopedia of Food and Health, Caffeine: Characterization and Properties, 2016, 556-572.  
[3] A. Al-Maaieh and D. R. Flanagan, J. Pharm. Sci. 91 (2002) 1000-1008.

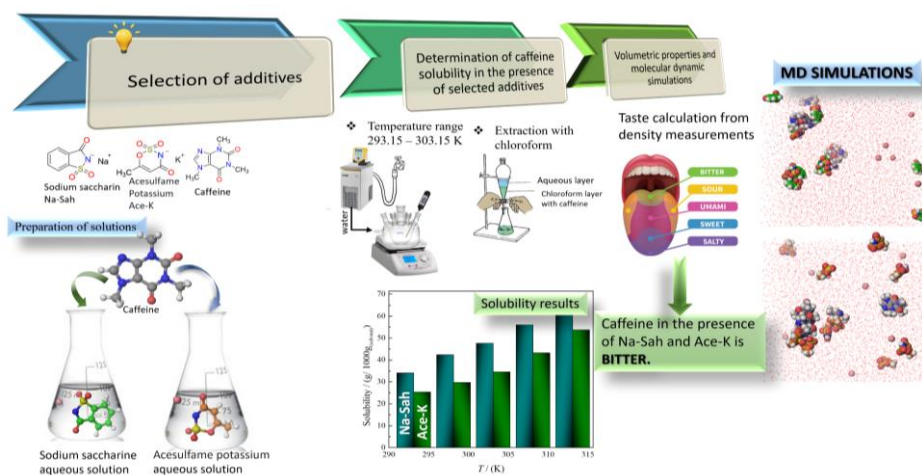



## ANALIZA NOVIH KINUKLIDINA KAO POTENCIJALNIH REAKTIVATORA INHIBIRANIH KOLINESTERAZA BOJNIM OTROVIMA

### ANALYSIS OF NEW QUINUCLIDINES AS POTENTIAL OF CHOLINESTERASE INHIBITED BY NERVE AGENTS

**Andela Plavec<sup>1</sup>, Dora Kolić<sup>1</sup>, Ines Primožič<sup>2</sup>, Zrinka Kovarik<sup>1</sup>**

<sup>1</sup>Institut za medicinska istraživanja i medicine rada, Zavod za toksikologiju, Ksaverska cesta 2, 10001 Zagreb, Hrvatska

<sup>2</sup>Sveučilište u Zagrebu Prirodoslovno-matematički fakultet, Kemijski odsjek, Horvatovac 102A, 10001 Zagreb, Hrvatska  
aplavec@imi.hr

Acetilholinesteraza (AChE, EC 3.1.1.7) i butirilkolinesteraza (BChE, EC 3.1.1.8) su dva srodna i životno važna enzima. U organizmu su zadužene za prijenos živčanih impulsa na kolinergičkim i živčano-mišićnim sinapsama na način da hidroliziraju acetilkolin (ACh), prijenosnika živčanih impulsa. Organofosforni spojevi (OP) inhibiraju ove enzime jer se kovalentno vežu na katalitički serin čime se onemogućava hidroliza ACh što dovodi do njegovog nakupljanja u sinapsama te dolazi do poremećaja u neurotransmisiji. Posljedice trovanja se očituju u grčenju mišića, napadajima i otežanom disanju, a može doći i do smrti [1]. U slučaju trovanja OP, reaktivacija kolinesteraza je moguća oksimima čija oksimska grupa (-NOH) ima kapacitet nukleofilnog napada na konjugirani fosforov atom na katalitičkom serinu, čime kolinesteraze postaju ponovno aktivne [2]. Cilj našeg istraživanja je ispitati učinkovitost serije kinuklidina s oksimskom skupinom i različitim supstituentima u reaktivaciji kolinesteraza s nekoliko bojnih otrova. Mjerenjem reverzibilne inhibicije AChE i BChE s kinuklidinskim spojevima određene su konstante disocijacije,  $K_i$ , u mikromolarnom području što odgovara prijašnjim rezultatima [3]. Reaktivacija AChE i BChE inhibiranih izabranim OP spojevima pomoću kinuklidinskim oksimima pokazala je njihov potencijal za razmatranje daljnjeg istraživanja u području razvoja antidota kod otrovanja bojnim otrovima.

- [1] A. Bosak et al., Arh. Hig. Rada Toksikol. 62 (2011) 445-457.  
[2] Z. Kovarik amd N. Maček Hrvat, Neuropharmacology 171 (2020) 108111.  
[3] A. Zandona et al., Arch. Toxicol. 94 (2020) 3157–3171.

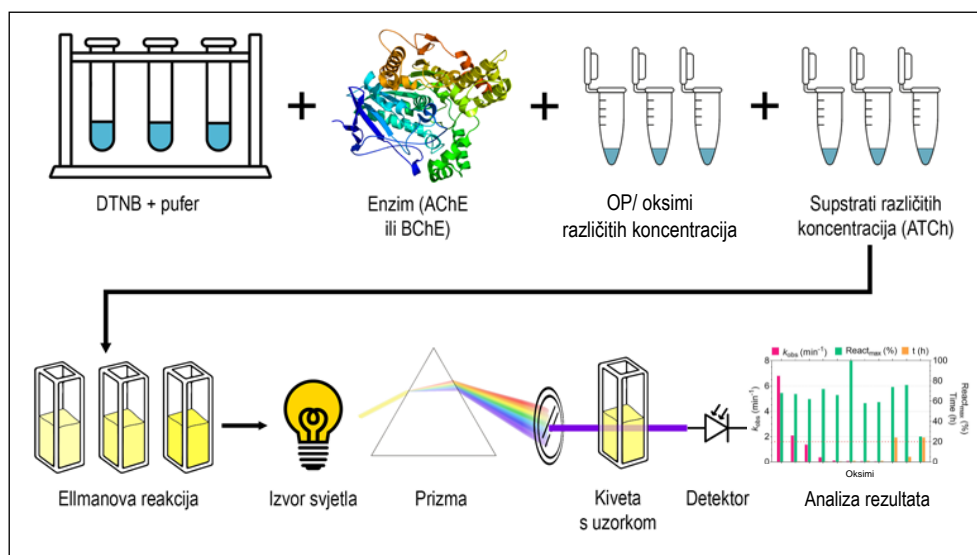

Prikaz postupka mjerenja reaktivacije kolinesteraza.

## GREEN SYNTHESIS OF BENZOXAZOLE DERIVATIVES

**Anja Rakas, Leda Kolarek, Tatjana Gazivoda Kraljević**

University of Zagreb Faculty of Chemical Engineering and Technology, Trg Marka Marulića 20, 10000  
Zagreb, Croatia  
arakas@fkit.unizg.hr

Contemporary investigations not only highlight the environmental advantages inherent in green methodologies compared to traditional synthesis approaches but also emphasize their heightened efficiency and economic viability [1]. Substituting conventional heating methods with advanced techniques such as microwave or ultrasonic irradiation has demonstrated remarkable outcomes, showcased significantly shortened reaction times and increased overall yields. One domain where these advancements hold particular significance is in drug discovery research [2]. More than 80% of commercially available drugs feature heterocyclic compounds as integral components. These compounds, characterized by diverse ring structures, play pivotal roles in the drug development process. Among them, the benzoxazole ring, has emerged as a noteworthy scaffold to drug discovery efforts owing to its significant bioactivity [3]. This paper describes synthesis of 2-substituted benzoxazole derivatives employing environmentally friendly synthetic methods, including microwave-assisted synthesis, ultrasound-assisted synthesis, mechanochemical synthesis, and the use of deep eutectic solvents. The corresponding benzaldehyde derivatives were prepared by the O-alkylation reaction of 4-hydroxybenzaldehyde, which were converted with 2-aminophenol into Schiff's bases, which in the last step gave the targeted 2-substituted benzoxazole derivatives by oxidative cyclization reaction. The structures of all synthesized compounds were confirmed by NMR spectroscopy.

- [1] K. N. Ganesh et al., *Org. Proces Res. Dev.* 25 (2021) 1455-1459.  
 [2] E. A. Hafez et al., *Green Chem. Lett. Rev.* 6 (2023) 189-210.  
 [3] Y. S. Kuniawan et al., *J. Multidiscipl. Appl. Nat. Sci.* 18 (2021) 145-157.

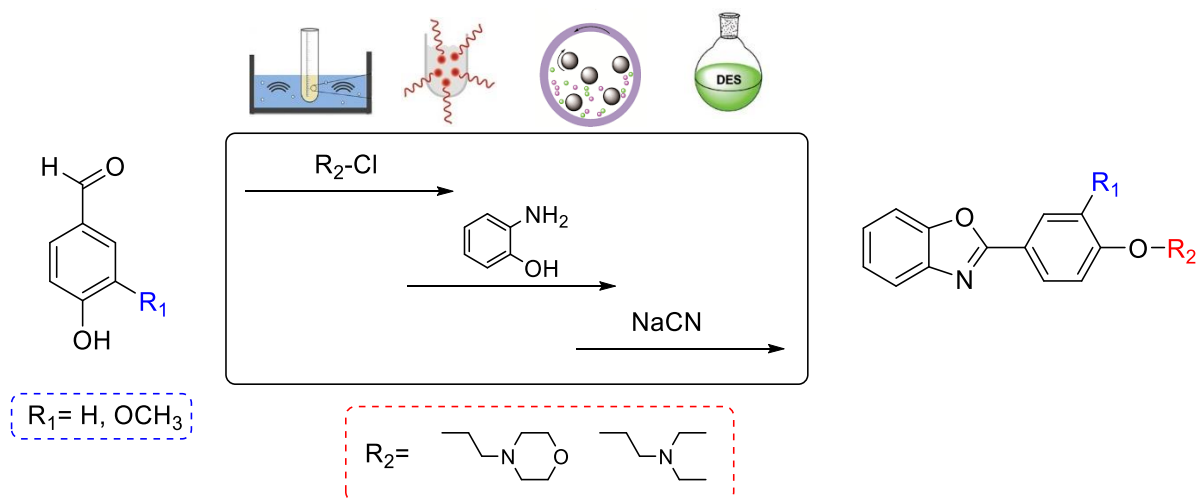

## DETERMINATION OF HEAVY METAL CONTENT IN SAMPLES OF *TARAXACUM OFFICINALE* FROM URBAN LOCATIONS IN THE MUNICIPALITY OF VISOKO IN BOSNIA AND HERZEGOVINA

**Emina Ramić<sup>1</sup>, Aida Šapčanin<sup>1</sup>, Alma Omanović<sup>1</sup>, Sabina Žero<sup>2</sup>**

<sup>1</sup>University of Sarajevo, Faculty of Pharmacy, Zmaja od Bosne 8, 71000 Sarajevo, Bosnia and Herzegovina

<sup>2</sup>University of Sarajevo, Faculty of Science, Zmaja od Bosne 33-35, 71000 Sarajevo, Bosnia and Herzegovina  
emina.ramich@gmail.com

*Taraxacum officinale* (dandelion) is a plant that is often used as an indicator of environmental condition posed to heavy metal content. Furthermore, it is used for soil phytoremediation. Parts of this plant such as the leaf, root, and flower are consumed as food and used in traditional medicine. In fact, *Taraxacum officinale* is used as medicine for kidney diseases, diabetes, bacterial infections, liver, kidney, and spleen disorders, with highlighted diuretic and anti-inflammatory effects. The aim of this study was to determine the content of Cu, Mn, Cd, and Pb in the leaves and roots of *Taraxacum officinale* from seven urban locations in the municipality of Visoko in Bosnia and Herzegovina, in order to evaluate whether *Taraxacum officinale* is safe to be consumed as food and used in traditional medicine. The samples for analysis were prepared by acid digestion, and the metal content was determined by flame atomic absorption spectrometry (FAAS). The content of heavy metals in leaf and root samples from urban locations were: Cu (from 8.4 µg/g to 20.06 µg/g), Mn (from 27.54 µg/g to 54.98 µg/g), Cd (from <LOD to 0.35 µg/g), and Pb (from <LOD to 10.42 µg/g). In the leaf sample, the Cd content (0.35 µg/g) from the Dobrinje location and the Pb content (10.42 µg/g) from the Čekrekčija location were above the maximum allowed concentrations given by the World Health Organization (WHO). The results indicate that it is very important to monitor the concentration of heavy metals in *Taraxacum officinale* before using it in food or medicinal products.

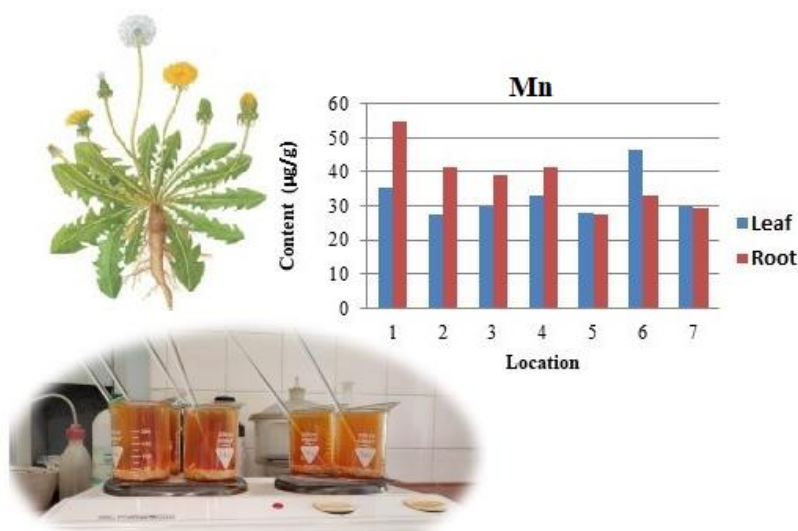

## FISTULINA HEPATICA AND VOLVOPLUTEUS GLOIOCEPHALUS FUNGAL EXTRACTS: EXPLORING THEIR THERAPEUTIC POTENTIAL THROUGH IN VITRO INHIBITION OF $\alpha$ -AMYLASE

**Milena Rašeta<sup>1</sup>, Jovana Mišković<sup>2</sup>, Marina Panić<sup>1</sup>, Maša Pal<sup>1</sup>, Sofija Bekić<sup>1</sup>, Gordana Gojgić-Cvijović<sup>3</sup>, Maja Karaman<sup>2</sup>**

<sup>1</sup> University of Novi Sad, Faculty of Sciences, Department of Chemistry, Biochemistry and Environmental Protection, Trg Dositeja Obradovića 3, 21000 Novi Sad, Serbia

<sup>2</sup> University of Novi Sad, Faculty of Sciences, Department of Biology and Ecology, ProFungi Laboratory, Trg Dositeja Obradovića 2, 21000 Novi Sad, Serbia

<sup>3</sup> University of Belgrade, Institute of Chemistry, Technology and Metallurgy, Department of Chemistry, Njegoševa 12, Belgrade 11001, Serbia  
milena.raseta@dh.uns.ac.rs

Continuing our exploration of biologically active mushroom species, this study delves into the *in vitro* antidiabetic properties of two edible and medicinal mushrooms: *Fistulina hepatica* (Schaeff.) With. 1801 and *Volvopluteus gloiocephalus* (DC.) Vizzini, Contu & Justo. In this investigation, we conducted *in vitro* assays on the  $\alpha$ -amylase enzyme inhibition using methanolic, ethanolic, and polysaccharide extracts from the selected mushrooms. Additionally, we characterized the phenolic profile through the LC-MS/MS technique and analyzed polysaccharides using the FTIR technique.

Our findings from the enzyme inhibition study indicate that the most promising potential lies with the EtOH extract of *V. gloiocephalus* (436.97 $\pm$ 7.95 mg AKAE/g d.w.), closely followed by the polysaccharide extract of *F. hepatica* (431.54 $\pm$ 4.07 mg AKAE/g d.w.). Comparable activity was observed for other examined activities at the tested concentration. The predominant compounds identified through LC-MS/MS are quinic acid (500.78 - 814.08 ng/mL d.w.) in *F. hepatica* extracts and cinnamic acid (382 - 604 ng/mL d.w.) in *V. gloiocephalus*. The FTIR spectrum of the *F. hepatica* extract revealed characteristic bands associated with polysaccharides and aromatic compounds, with the absence of the protein band in the 1655-1630  $\text{cm}^{-1}$  region. In contrast, the *V. gloiocephalus* extract FTIR spectrum displayed peaks indicating the presence of polysaccharides, proteins, and aromatic compounds. Strong absorption signals at 1637 and 1549  $\text{cm}^{-1}$  were attributed to protein amide vibrations in the case of *V. gloiocephalus*, with the intense signal at 1637  $\text{cm}^{-1}$  overlapping with absorption typical for aromatic compounds and associated water absorption [1]. This study, the first of its kind, highlights the *in vitro* antidiabetic potential through  $\alpha$ -amylase inhibition with the tested extracts, making the investigated species more promising for type-2 diabetes, possibly owing to the synergistic effect of mushrooms' primary and secondary metabolites.

[1] G. Beltrame et al., J. Fungi. 7 (2021) 189.

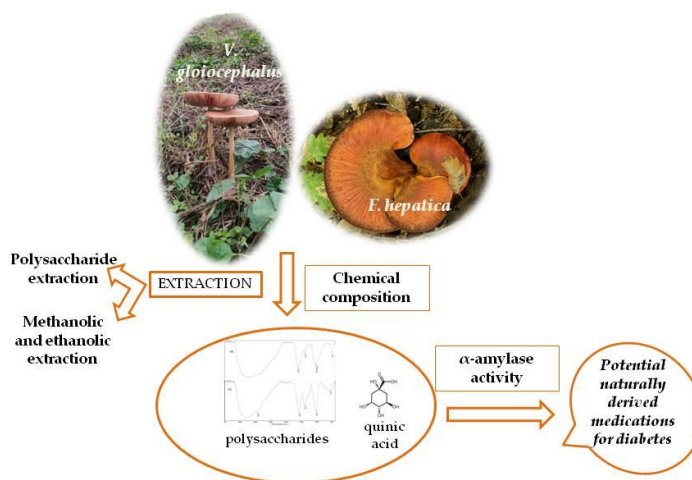

## SYNTHESIS AND BIOLOGICAL ACTIVITY OF AMIDINO-SUBSTITUTED N-METHYLBENZIMIDAZOLE DERIVED BENZAMIDES

**Viktoria Ravlić<sup>1</sup>, Anja Beč<sup>1</sup>, Dirk Daelemans<sup>2</sup>, Leentje Persoons<sup>2</sup>, Mihailo Banjanac<sup>3</sup>, Vedrana Radovanović<sup>3</sup>, Marijana Hranjec<sup>1</sup>**

<sup>1</sup>University of Zagreb Faculty of Chemical Engineering and Technology, Trg Marka Marulića 19, 10000 Zagreb, Croatia

<sup>2</sup>KU Leuven, Department of Microbiology, Immunology and Transplantation, Rega Institute, Leuven, Belgium

<sup>3</sup>Pharmacology *in vitro*, Selvita Ltd., Prilaz baruna Filipovića 29, 10000 Zagreb, Croatia

vrvlic@fkit.unizg.hr

Amides represent one of the most important groups of compounds in organic chemistry because they are of great importance for biological organisms. Many compounds that are crucial for the survival of life contain an amide bond in their structure, such as proteins, enzymes, vitamins, hormones, antibodies, neurotransmitters [1]. In addition to natural compounds, amides are highly represented in the pharmaceutical industry, as well as benzimidazoles, heterocyclic compounds of exceptional stability, and are an integral part of numerous drugs such as anthelmintics, antivirals, antiparasitics, antifungals, analgesics and antitumor drugs. Amidine substituents at the end of the molecule significantly contribute to the interaction with biological macromolecules and thus contribute to the biological stability of the complex due to the possibility of creating hydrogen bonds and/or electrostatic interactions [2]. This work presents the synthesis, structural characterization and biological evaluation of new benzamides of *N*-substituted benzimidazoles having different number of methoxy groups placed on the phenyl ring. Targeted 2-benzimidazolyl-substituted benzamides were prepared by condensation of 2-amino-*N*-methylbenzimidazole with corresponding carboxylic acids which underwent the Pinner reaction. The structures of all newly prepared compounds were confirmed by using NMR spectroscopy. All prepared compounds were tested for antiproliferative and antibacterial activity *in vitro*.

[1] M. Cindrić et al., Eur. J. Med. Chem. 136 (2017) 468–479.

[2] M. Hranjec et al., J. Med. Chem. 51 (2008) 4899–4910.

128

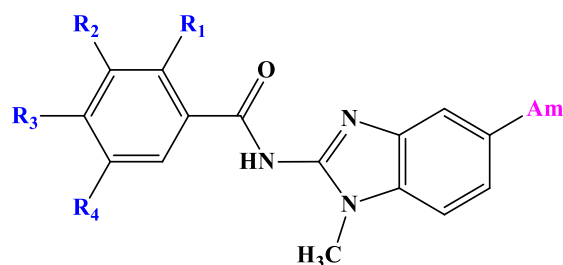

$R_1, R_2, R_3, R_4 = \text{OCH}_3$

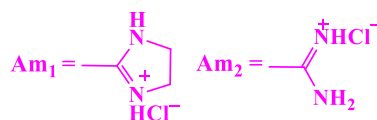

## BIOACTIVE COMPOUNDS AND ANTIOXIDATIVE POTENTIAL OF THREE PURPLE *BRASSICACEAE* MICROGREEN SPECIES

**Anja Saveljić, Olja Šovljanski, Teodora Cvanić, Vanja Travičić, Jelena Vulić, Gordana Četković, Jasna Čanadanović-Brunet**

University of Novi Sad, Faculty of Technology, Bulevar Cara Lazara 1, 21000 Novi Sad, Serbia  
teodora.cvanic@uns.ac.rs

Microgreens, 40 times more nutritious than their mature plants, are considered an emerging class of fresh functional food, while also increasing available space put into food production, with both environmental benefits and economic profitability. Therefore, with more than 80-100 identified crop varieties, they are quickly grabbing the attention of researchers worldwide. They are becoming part of sustainable farming, as well as novel specialty crops with great health benefits to consumers' health. Microgreens are young immature greens that are between the sprout and baby greens stages of growth, produced from the seeds of herbs, vegetables, and grains. Health-promoting properties connected to their consumption are related to present levels of physiologically active chemicals, including minerals, vitamins, and antioxidants [1]. The current research was focused on the investigation of the present bioactive compounds (phenolics, flavonoids, carotenoids, anthocyanidins, and chlorophylls) and antioxidative potential (DPPH<sup>•</sup>, ABTS<sup>•+</sup>, and reduction power assays) of three different microgreen species belonging to the *Brassicaceae* family (kohlrabi, sango radish, and red cabbage). For sample preparation, fresh plants were lyophilized for 48 hours and homogenized as powder. Dried samples were extracted using ultrasound for 30 minutes following the 30 minutes on the laboratory shaker, with 50% ethanol solution as a solvent for hydrophilic components and acetone: ethanol (50:50) solution for lipophilic compounds. After the centrifuge and supernatant separation, extracts were used for further spectrophotometrical analyses. Based on the results all three samples have showcased vast potential as functional food components, with high amounts of various bioactive components and high antioxidant potential. Fairly similar content of flavonoids was found among all three species varying slightly between 333 and 33 mg/100g. The highest amount of vitamin C presence was determined in red cabbage extracts (mg/100g). For all other measured parameters, sango radish showed the best results, with 3140.36 mg/g of total phenolics, 468.14 mg/100g of anthocyanidins, 51.65 mg/100g of carotenoids and 4280.54 mg/100g of total chlorophylls. Furthermore, the highest scavenger activity against both DPPH<sup>•</sup> and ABTS<sup>•+</sup> radicals, as well as the highest reducing power activity was found also in sango radish extract, with 5.26, 20.72, and 5.22 mM TE/g dried sample, respectively. The obtained results highlight the value of these microgreen species. Their biological activity combined with interesting pigments gives valuable insight into the potential future application of microgreens as ingredients in functional food, and more.

129

[1] U. Rai et al., Environ. Ecol. 40 (2022) 2239-2244.

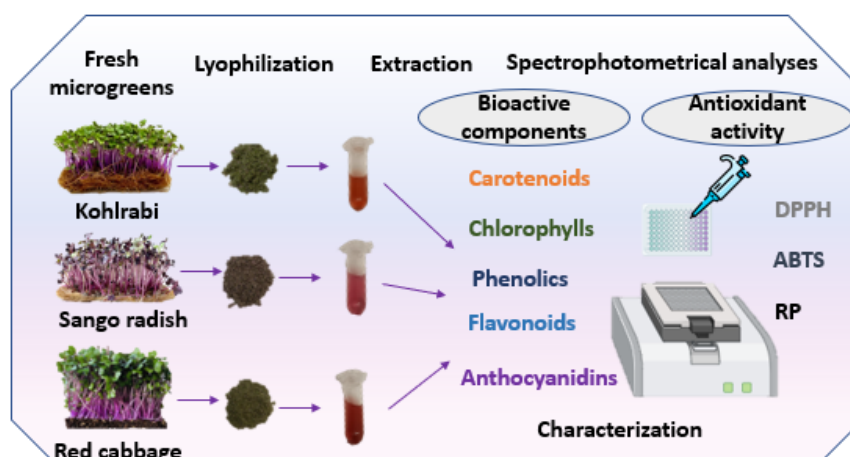

## NANOPARTICLES FROM SOY PROTEIN AS POTENTIAL CARRIERS OF HYDROPHILIC AND HYDROPHOBIC BIOACTIVES

**Marina Savić, Milica Perović, Mirjana Antov**

University of Novi Sad, Faculty of Technology, Boulevard cara Lazara 1, 21 000 Novi Sad, Serbia  
savic.56.20.p@uns.ac.rs

In recent times, the growing consciousness regarding both quality and safety of food intake, coupled with the rising global population, drives research toward development of sustainable and high-nutrition food with no negative impact on the environment. Globally, there is a constant search for alternative protein sources that should provide healthier and lower-cost alternatives to animal-based proteins. It is known that plant proteins are widely distributed, isolated from inexpensive sources and have numerous benefits on human health [1]. The main objective of this research was to examine the possibility and conditions for the preparation of soy protein nanoparticles. In addition, their potential for binding hydrophobic and hydrophilic bioactive molecules was studied. Protein isolate from defatted soy grit showed maximal solubility (100%) at pH 9. Protein nanoparticles were prepared by two different methods - heat treatment and cold gelation. Smaller nanoparticles were obtained through the thermal treatment (90 °C, 10 min, pH 6 or 9) in comparison to those formed by cold gelation, and their size varied from 70 to 130 nm. Nanoparticles from soy protein showed ability to bind both linoleic acid and anthocyanins from blueberry juice.

[1] S. Y. J. Sim et al., Foods 10 (2021) 1967.

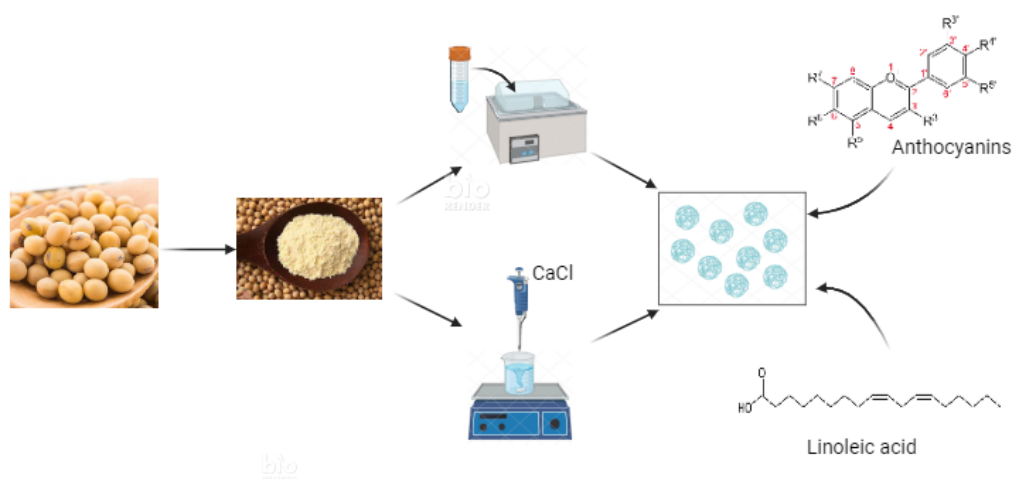

## INVESTIGATING THE INHIBITORY EFFICIENCY OF THE SELECTED THIAZOLE DERIVATIVES ON COPPER CORROSION IN ACIDIC ENVIRONMENT

**Nikolina Tapavica, Đendi Vaštag**

University of Novi Sad, Faculty of Sciences, Department of Chemistry, Biochemistry and Environmental Protection,  
Trg Dositeja Obradovića 3, 21000 Novi Sad, Serbia  
nikolinatapa@gmail.com

Corrosion of metals, a natural phenomenon, is the gradual destruction of metals and alloys by chemical and/or electrochemical reactions with their environment, which costs the world economy a lot of money every year and causes dangerous ecological impacts. The corrosion process cannot be completely stopped, it can only be slowed down by applying various forms of corrosion protection [1]. Copper is a strategic metal in various industrial fields in heating and in cooling systems [2]. This study investigated the possibility of protecting copper from corrosion in an acidic environment using corrosion inhibitors. The inhibitory properties of the selected thiazole derivative were tested for copper corrosion in an acidic sulfate environment. The inhibitory efficiency of the tested derivative was determined as a function of concentration using potentiostatic polarization measurements. It was found that within the tested concentration range, the inhibitory efficiency of the tested thiazole derivative increases with increasing its concentration. The obtained results also show that the tested derivative acts as a mixed inhibitor of copper corrosion in an acidic environment, during which it is adsorbed on the metal surface according to the Langmuir isotherm mechanism.

[1] P.A. Schweitzer, Fundamentals of Corrosion, Boca Raton, CRC Press, 2010.

[2] A. Al Bahir, Int. J. Electrochemistry. Sci. 18 (2023) 100040.

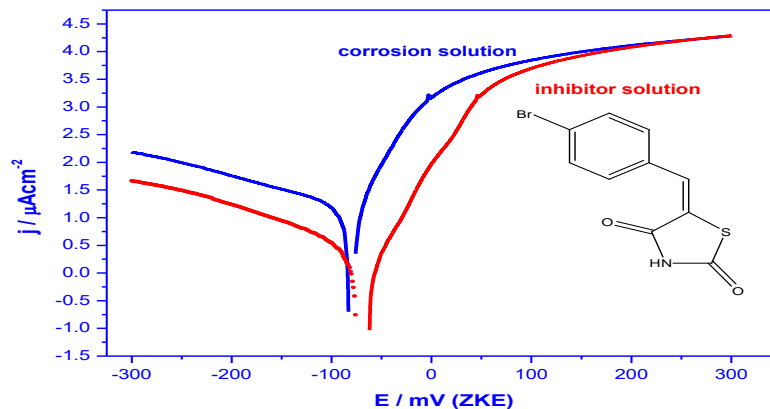



# SYNTHESIS AND ANTIPROLIFERATIVE EVALUATION OF NOVEL C6-SUBSTITUTED PURINE-ISOXSAZOLE DERIVATIVES AND THEIR Re(I) TRICARBONYL COMPLEXES

**Marina Ter<sup>1</sup>, Leon Sačer<sup>1</sup>, Martina Piškor<sup>1</sup>, Leentje Persoons<sup>2</sup>, Dirk Daelemans<sup>2</sup>, Silvana Raić-Malić<sup>1</sup>**

<sup>1</sup>University of Zagreb Faculty of Chemical Engineering and Technology, Trg Marka Marulića 19, 10000 Zagreb, Croatia

<sup>2</sup>KU Leuven, Department of Microbiology, Immunology and Transplantation, Laboratory of Virology and Chemotherapy, Rega Institute, Leuven, Belgium  
mter@fkit.unizg.hr

Cancer cells promote the *de novo* biosynthesis of purines, the building blocks of nucleic acids, as a rational strategy to thrive and proliferate; therefore, purine analogues offer a formidable pharmacological strategy as anticancer agents. Despite their structural similarity, they exhibit different biochemical activities that have promising potential as therapeutics against various diseases. Remarkably, even the modification of a single atom in purine analogues can lead to very different biological effects [1]. In our previous studies, 6-chloro-7-deazapurine derivative was found to have a pronounced inhibitory effect against HeLa cell lines ( $IC_{50} = 0.98 \mu M$ ) and CFPAC-1 cell lines ( $IC_{50} = 0.79 \mu M$ ), while 1-(*p*-chlorophenyl)-1,2,3-triazole-tagged benzimidazole displayed the most pronounced and highly selective inhibitory effect in nM range on non-small cell lung cancer A549 [2, 3]. In addition, our results indicated that Re(I) tricarbonyl complexes exerted a remarkable antiproliferative effect on colon cancer cells, especially CT26 and HT29 [4]. Motivated by our previously published results related to the synthesis of biologically active purine bioisosteres and Re(I) tricarbonyl complexes and by the biological potential of this nitrogen scaffold, we present here the design, synthesis, antiproliferative activity and spectroscopic characterisation of purine-isoxazole hybrids and their Re(I) complexes.

- [1] E. Bilget Guven et al., RSC Med. Chem. 14 (2023) 2658–2676.  
[2] A. Bistrovic et al., J. Enzyme Inhib. Med. Chem. 33 (2018) 271–285.  
[3] A. Bistrovic et al., Int. J. Mol. Sci. 18 (2017) 2292-2212.  
[4] S. Jakopec et al., Dalton Trans. 52 (2023) 9482–9498.

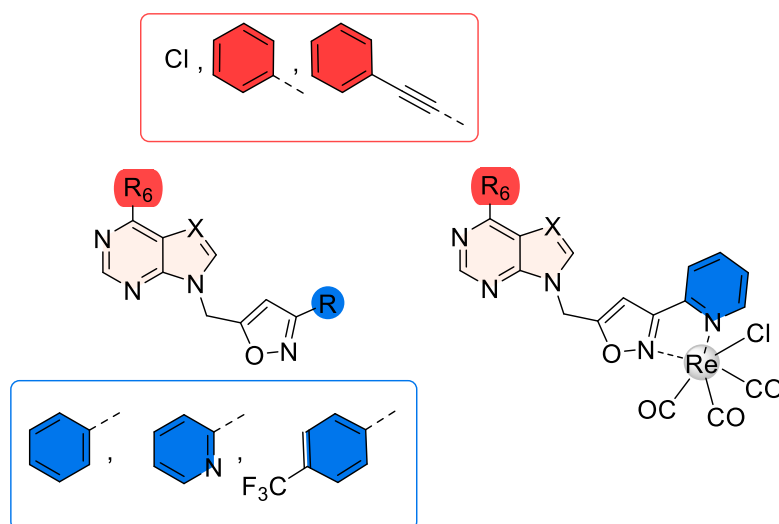

## THE CONTENT OF SELECTED METALS IN THE SHELL AND KERNEL OF SWEET AND WILD CHESTNUT FROM BOSNIA AND HERZEGOVINA

**Amina Tinjak<sup>1</sup>, Sabina Žero<sup>1</sup>, Jasna Huremović<sup>1</sup>, Alisa Selović<sup>1</sup>, Emina Ramić<sup>2</sup>**

<sup>1</sup> Univerzitet u Sarajevu, Prirodno-matematički fakultet, Zmaja od Bosne 33-35, 71000 Sarajevo, Bosna i Hercegovina

<sup>2</sup> Univerzitet u Sarajevu, Farmaceutski fakultet, Zmaja od Bosne 8, 71000 Sarajevo, Bosna i Hercegovina  
sabina\_zero@hotmail.com

Chestnut forests are widespread in most countries of southern Europe, including Bosnia and Herzegovina, and so is chestnut consumption. However, if the consumed chestnuts are from areas contaminated with metals, people are exposed to the risk of heavy metal accumulation in their organs. This study determined and compared the concentrations of selected metals in sweet (n=3) and wild (n=3) chestnuts, as well as the kernels and inner shell of these samples, taken from different localities in Konjic and the Sarajevo area. The following metals Cr, Cu, Mn, Fe, Ni, Cd, Pb and Zn were determined by flame atomic absorption spectrometry (FAAS). The samples were prepared in two ways: acid digestion and extraction in water. The metal content obtained after acid digestion of chestnut inner shell or kernel ranged from: Zn (4.21 – 23.36 µg/g); Fe (7.95 – 40.54 µg/g); Cu (3.40 – 10.38 µg/g); Mn (2.28 – 103.3 µg/g); Cr (< LOD (limit of detection) – 0.40 µg/g); Ni (< LOD – 0.72 µg/g); Cd and Pb concentrations were below the detection limit of the method used in all samples. The metal content obtained after the extraction of chestnut samples in water ranged from: Cr (< LOD – 0.10 µg/g); Cu (0.37 – 16.80 µg/g); Mn (1.46 – 40.46 µg/g); Fe (0.08 – 4.01 µg/g); Zn (0.79 – 16.65 µg/g); Ni (< LOD – 1.73 µg/g); concentrations of Cd and Pb were below the detection limit of the method used in all samples. The highest content of Cu and Cr was determined in wild chestnuts, while Mn, Fe, Zn and Ni were determined in sweet chestnuts. The metal content in the inner shell and kernel of the same sample varies depending on the metal analysed, as well as the method of sample preparation.

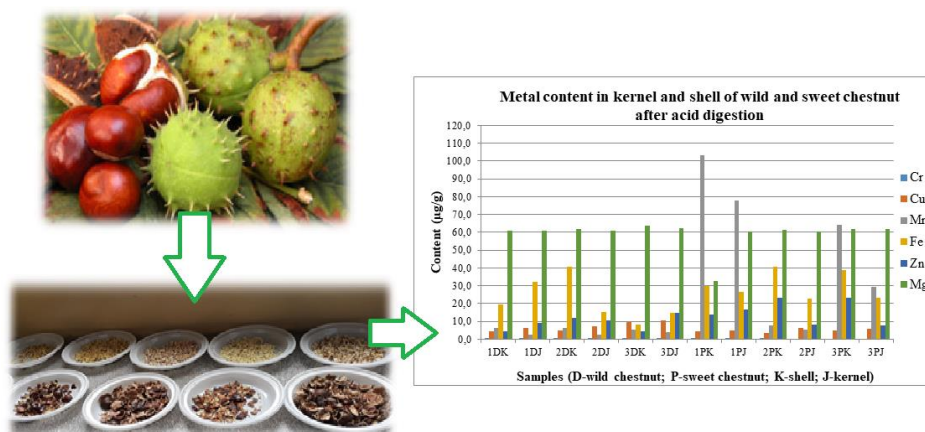

# KARAKTERIZACIJA I OTAPANJE NANOČESTICA FLUORITA ( $\text{CaF}_2$ )

## CHARACTERIZATION AND DISSOLUTION OF FLUORITE ( $\text{CaF}_2$ ) NANOPARTICLES

**Ivor Vavra Plavšić, Juraj Nikolić, Tajana Begović**

Sveučilište u Zagrebu Prirodoslovno-matematički fakultet, Kemijski odsjek, Horvatovac 102a, 10000 Zagreb, Hrvatska  
ivavraplavsic@chem.pmf.hr

Fluorit je polimorf kalcijevog fluorida i slabo je topljiv u vodi. Ima široku industrijsku primjenu kao sirovina za dobivanje fluorovodične kiseline, u proizvodnji aluminijske, za izradu optičkih elemenata poput spektroskopskih prozora, zrcala itd. [1]. Sirovi fluorit se pročišćava procesom flotacije u kojem se od hidrofilnih nečistoća pročišćuje propuhivanjem zraka kroz suspenziju fluorita pri čemu se hidrofobne čestice fluorita vežu na mjehuriće zraka i isplivaju na površinu [2]. Na proces flotacije važan utjecaj imaju površinska svojstva i otapanje fluorita u vodi stoga je uvid u te procese koristan za povećanje efikasnosti flotacije [3]. Nadalje, uranijev dioksid koji je prisutan u nuklearnom otpadu kristalizira po tipu kristalne rešetke fluorita stoga se fluorit može koristiti kao modelni sustav za proučavanje otapanja uranijeva dioksida kako bi se izbjeglo korištenje složenih eksperimentalnih postava zbog njegove radioaktivnosti [4].

U ovom istraživanju nanočestice fluorita su karakterizirane metodama rendgenske difrakcije na prahu, Brunauer–Emmett–Teller analize, skenirajuće elektronske mikroskopije i dinamičkog raspršenja svjetlosti pomoću kojih je određena čistoća, specifična površina, oblik i srednja veličina nanočestica. Kinetika otapanja nanočestica fluorita u vodi praćena je pomoću fluoridne i kalcijeve ion-selektivne elektrode. Uz pomoć navedenih metoda, istražena je ovisnost kinetike otapanja nanočestica fluorita o pH vrijednosti otopine, temperaturi i vrsti inertnog elektrolita. Iz provedenih mjerenja, određena je konstanta brzine otapanja nanočestica fluorita te red reakcije s obzirom na  $\text{H}^+$  ione, energija aktivacije i Arrheniusov predskponencijalni faktor. Uočeno je da je otapanje nanočestica fluorita nestehiometrijsko te da u otopini postoji suvišak kalcijevih iona u odnosu na fluoridne ione.

- [1] M. J. Janicki et al., Physicochem. Probl. Miner. Process. 52 (2016) 451–458.  
[2] Y. Foucaud et al., J. Phys. Chem. B 122 (2018) 12403–12410.  
[3] L. Wu, W. Forsling, J. Colloid Interface Sci. 174 (1995) 178–184.  
[4] J. R. A. Godinho et al., J. Nucl. Mater. 419 (2011) 46–51.

Istraživanje je napravljeno u sklopu projekta Hrvatske zaklade za znanost „Fizikalna kemija procesa na međupovršini mineral/otopina (poli)elektrolita“ (IP-2020-02-9571).

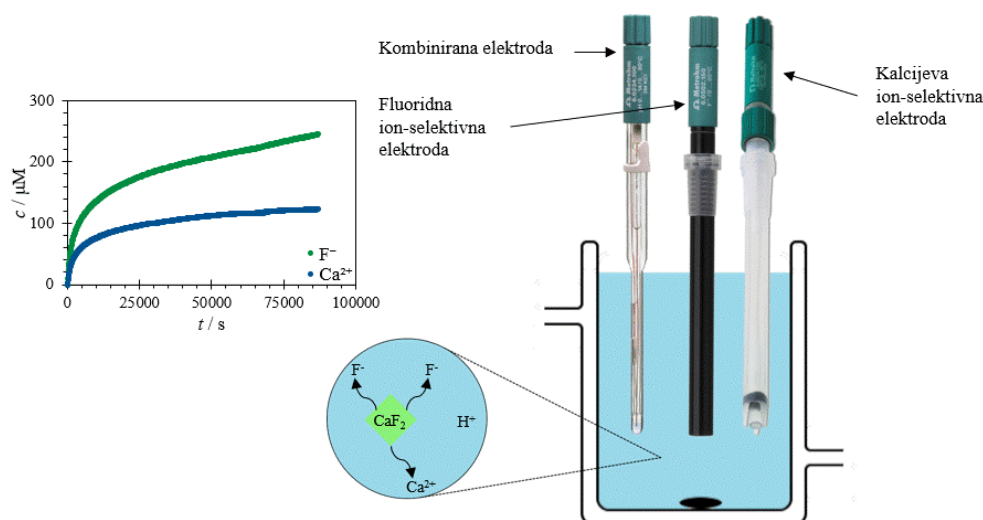

# QUANTITATIVE DETERMINATION OF LIMONENE AND EUCALYPTOL IN ESSENTIAL OILS USING GC-MS/MS

**Ana Vučak, Petra Zelić, Dorja Boras, Franko Burčul**

University of Split, Faculty of Chemistry and Technology, Ruđera Boškovića 35, 21000 Split, Croatia  
ana.vucak@ktf-split.hr

Limonene is a cyclic monoterpene and a common component of many essential oils, especially ones obtained by cold-pressing *Citrus* peels. Eucalyptol (1,8-cineole), bicycle monoterpene ether, is the main compound of eucalyptus essential oil as well as a fresh aroma compound in essential oils distilled from the leaves of other *Myrtaceae* plants. Due to the many benefits observed from the everyday use of essential oils and the known antimicrobial, anti-inflammatory and antioxidant activity of limonene and eucalyptol, these compounds are extensively researched and there is a need for analytical methods for their simple and fast quantification [1,2].

Gas chromatography hyphenated with tandem mass spectrometry (GC-MS/MS) is a suitable technique for qualitative and quantitative determination of volatile essential oils constituents. Standards of limonene and eucalyptol and hexane as a solvent were used for the preparation of standard solutions. Gas chromatography was applied for the separation of limonene and eucalyptol and was optimized by changing the oven temperature program rate. A triple quadrupole mass spectrometer, in MRM scan mode, was used for monitoring specific fragmentation reactions (quantifier and two qualifiers for each compound). Mass spectrometry was optimized by the determination of the collision energy with nitrogen for each specific reaction of fragmentation. The developed method enables determination of limonene and eucalyptol in the concentration range of 0.25-10.0 µg/mL. The method validation parameters: accuracy, precision, linearity, the limit of detection and the limit of quantification were proven satisfactory.

The method was successfully applied in the analysis of following essential oils: lemon (*Citrus limon* L.), grapefruit (*Citrus x paradisi* Macfad), tangerine (*Citrus reticulata* Blanco), celery (*Apium graveolens* L.), eucalyptus (*Eucalyptus globulus* Labill.), niaouli (*Melaleuca quinquenervia* (Cav.) S.T.Blake), cajuput (*Melaleuca cajuputi* Powell) and myrtle (*Myrtus communis* L.).

- [1] A. J. Vieira et al., Chem. Biol. Interact. 283 (2018) 97-106.  
[2] C. Sa et al., Chromatogr. 35 (2021) e5080.

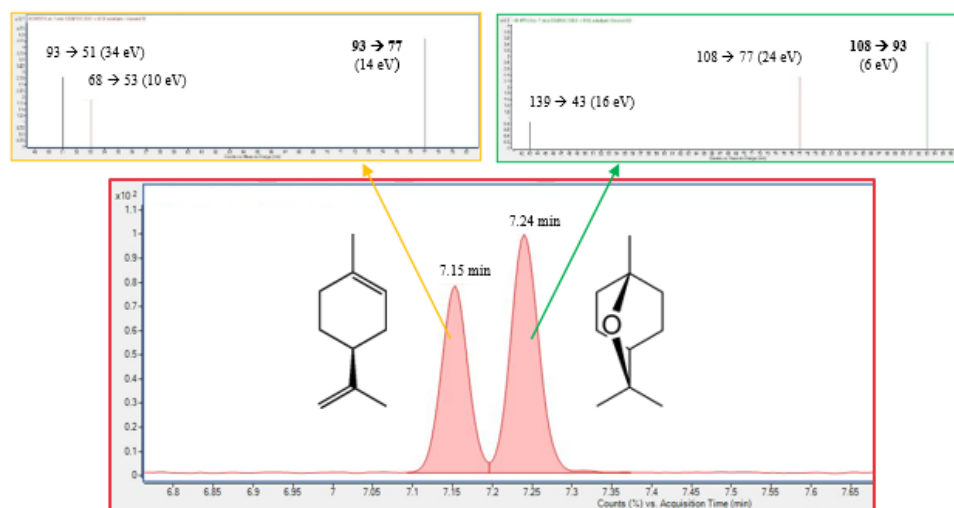

Figure 1. Chromatogram and MS/MS spectra of limonene (left) and eucalyptol (right)

## EKSTRAKCIJA FARMACEUTIKA IZ VODE PRIMJENOM POLIMERNOG SORBENSA S OTISKOM SULFAMETOKSAZOLA

### EXTRACTION OF PHARMACEUTICALS FROM WATER USING SULFAMETOXAZOLE-IMPRINTED POLYMER

**Petra Vukovinski, Ramona Petko, Dragana Mutavdžić Pavlović, Kristina Tolić Čop**

Sveučilište u Zagrebu Fakultet kemijskog inženjerstva i tehnologije, Trg Marka Marulića 19, 10000 Zagreb, Hrvatska  
pvukovins@fkit.unizg.hr, rpetko@fkit.unizg.hr

Provedeno je istraživanje s ciljem razvoja učinkovite metode praćenja utjecaja sulfametoksazola, sulfonamidnog antibiotika koji se često primjenjuje u liječenju infekcija urinarnog i respiratornog sustava, na okoliš i vodene ekosustave. Ključni korak za osiguravanje osjetljivosti, linearnosti, selektivnosti i ponovljivosti metode jest ekstrakcija čvrstom fazom, koja predstavlja neophodnu pripremu uzorka. S obzirom da se sulfametoksazol, u stvarnim uzorcima, uvijek nalazi u smjesi od nekoliko farmaceutika, nužno je razviti selektivnu metodu za ekstrakciju sulfametoksazola zajedno s još deset farmaceutika. U tu je svrhu korišten polimerni sorbens s otiskom molekule (MIP) sulfametoksazola. Različiti MIP-ovi i polimerni sorbensi bez otiska molekule (NIP) pripremljeni su korištenjem dva različita funkcionalna monomera, 2-hidroksietil metakrilata (HEMA) i metakrilne kiseline (MAA) te je kao otapalo rabljen acetonitril (ACN). Rezultati istraživanja potvrdili su da je metakrilna kiselina bila optimalan monomer za ekstrakciju sulfametoksazola. Nakon selekcije optimalne kombinacije serijskog vezanja MIP sorbensa s komercijalnim Oasis HLB sorbensima, postignuta je uspješna ekstrakcija svih jedanaest farmaceutika. Nakon ekstrakcije, provedena je validacija metode te su određeni parametri poput linearnosti, granice detekcije i granice kvantifikacije, ponovljivosti i obnovljivosti pomoću tekućinskog kromatografa visoke djelotvornosti s nizom dioda (HPLC-DAD). Infracrvenom spektroskopijom s Fourierovom transformacijom (FTIR) i pretražnom elektronskom mikroskopijom (SEM) potvrđena je uspješnost procesa polimerizacije sorbensa i ispiranja molekula predloška s MIP-ova. SEM analiza potvrdila je prednost MAA-om pripremljenih sorbensa u odnosu na one pripremljene s HEMA-om, uz povećanje poroznosti površine kod veće količine acetonitrila.

Rezultati provedenog istraživanja jasno pokazuju prednost pripreme polimera s otiskom molekule sulfametoksazola za njegovu ekstrakciju, ali i ekstrakciju drugih farmaceutika iz uzorka vode. Ovakav pristup je primjenjiv i u drugim područjima, poput analize hrane i sedimenta, gdje složene matrice zahtijevaju učinkovite i selektivne metode ekstrakcije.

Ovaj rad je financirala Hrvatska zaklada za znanost projektom HRZZ-IP-2022-10-4400 pod nazivom *Razvoj polimera s otiskom molekula za primjenu u analizi farmaceutika i tijekom naprednih postupaka obrade voda (MIPdePharma)*

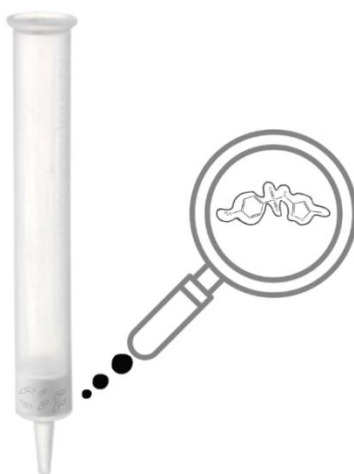

Farmaceutik	Učinkovitost, % (n=3)
Atenolol	75,33 ± 4,72
Prokain	86,75 ± 5,32
Ofloksacin	77,78 ± 2,57
Sulfametazin	70,44 ± 0,52
<b>Sulfametoksazol</b>	<b>102,49 ± 2,40</b>
Torasemid	95,23 ± 2,93
Karbamazepin	92,10 ± 4,58
Deksametazon	103,76 ± 7,82
β-estradiol	97,25 ± 6,33
Diazepam	81,79 ± 1,20
Diklofenak	95,49 ± 3,44

Polimerni sorbens	Učinkovitost, % (n=3)
MIP-MAA 3	79,37 ± 9,25
NIP-MAA 3	2,51 ± 13,22

## DIMERNE POVRŠINSKI AKTIVNE TVARI S DVOVALENTNIM PRIJELAZNIM METALIMA

### SELF-ASSEMBLY OF DIMERIC METALLOSURFACTANTS

**Leona Zagorec<sup>1</sup>, Darija Domazet Jurašin<sup>2</sup>**

<sup>1</sup>Sveučilište u Zagrebu Fakultet kemijskog inženjerstva i tehnologije, Trg Marka Marulića 19, 10000 Zagreb, Hrvatska

<sup>2</sup>Institut Ruđer Bošković, Bijenička cesta 54, 10000 Zagreb, Hrvatska  
lzagorec@fkit.unizg.hr

Sintetizirane su nove dimerne površinski aktivne tvari (PAT), bis(*N,N*-dimetil-*N*-dodecil)etilen-1,2-diamonijevog dibromida, koje u protuionu sadrže metalni ion kobalta, bakra ili cinka te su označene kao  $[\text{MBr}_4](\text{dim})$  ( $\text{M} = \text{Co}, \text{Cu}, \text{Zn}$ ). Dimerne PAT imaju važnu ulogu u farmaceutskoj industriji, medicini, proizvodnji lakova i premaza te su uvelike istraživane zbog širokog spektra karakterističnih svojstava. Uvođenjem metalnih iona u strukturu dvovalentnih dimernih PAT nastaju jedinstveni spojevi, koji osim sposobnosti adsorpcije i asocijacije, posjeduju redoks, magnetska, i katalitička svojstva. Otopine novosintetiziranih PAT istražene su mjerenjem površinske napetosti Du Noüyevom metodom, mjerenjem električne provodnosti, a veličina i zeta-potencijal micela određeni su dinamičkim (DLS) i elektroforetskim raspršenjem svjetlosti (ELS). Na temelju dobivenih rezultata utvrđeno je da se površinska aktivnost dimernih PAT povećava zamjenom uobičajenog halogenog  $\text{Br}^-$  protuiona, s kompleksnim  $[\text{MBr}_4]^{2-}$  protuionom, a vrijednosti kritične micelizacijske koncentracije (CMC) se pomiču prema manjim koncentracijama. Također, DLS rezultati pokazali su da sve  $[\text{MBr}_4](\text{dim})$  PAT pri istim koncentracijama asociiraju u cilindrične i veće micelle u odnosu na polaznu dimernu PAT. Razlike u fizikalno-kemijskim svojstvima unutar novosintetizirane serije PAT nisu jako izražene i više-manje su neovisne o vrsti metalnog iona. Uloga uvedenih iona dvovalentnih prijelaznih metala u protuionu PAT elektrostatske je prirode, odnosno ioni metala smanjuju elektrostatska odbijanja ionskih vrsta u otopini što dovodi do promjena u temeljnim svojstvima polazne PAT.

- [1] M. J. Rosen, Surfactants and Interfacial Phenomena, 3. izd., John Wiley & Sons, Inc., Hoboken, New Jersey, 2004.  
[2] L. Wang et al., Curr. Opin. Colloid Interface Sci., 35 (2018) 81–90.  
[3] R. Zana, Adv. Colloid Interface Sci., 97 (2002) 205–253.

Ovaj rad financiran je u sklopu EU projekta u okviru programa Obzor Europa br. 101057961 STOP (Surface Transfer Of Pathogens)

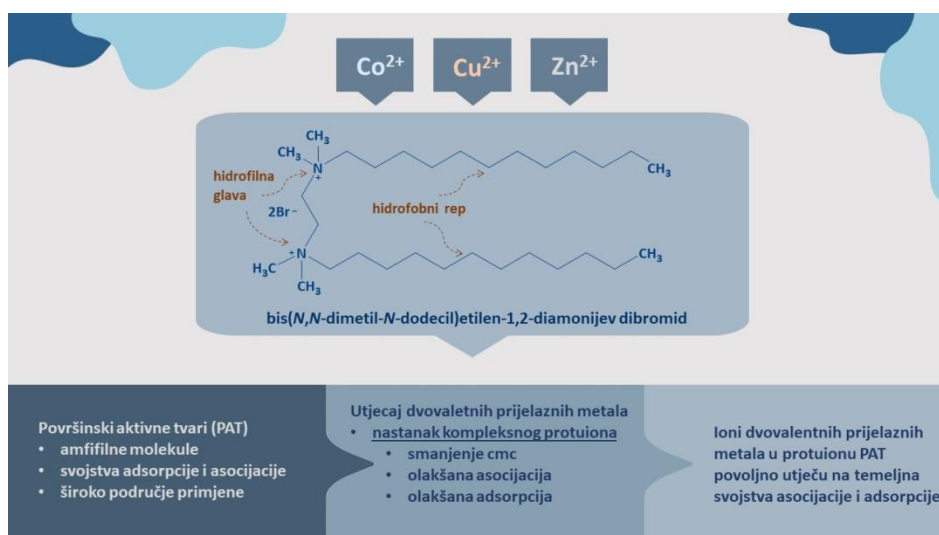

## DETERMINATION OF SELECTED METALS CONTENT IN CANNED FISH

**Sabina Žero<sup>1</sup>, Amar Erlagić<sup>1</sup>, Emina Ramić<sup>2</sup>**

<sup>1</sup> Univerzitet u Sarajevu, Prirodno-matematički fakultet, Zmaja od Bosne 33-35, 71000 Sarajevo, Bosna i Hercegovina

<sup>2</sup> Univerzitet u Sarajevu, Farmaceutski fakultet, Zmaja od Bosne 8, 71000 Sarajevo, Bosna i Hercegovina  
sabina\_zero@hotmail.com

Seafood, and thus fish living in potentially polluted water, can accumulate traces of metals. Water pollution with metals can affect human health and the food chain. The purpose of this study was to analyze selected metals: Cd, Cr, Cu, Fe, Mn, Ni, Pb, Zn, Ca and Mg in 15 samples of canned fish tuna (n=5), mackerel (n=5), and sardines (n=5) available on the Sarajevo market in Bosnia and Herzegovina. Metal concentrations were determined by flame atomic absorption spectrometry (FAAS) after digestion of the samples with nitric acid (65 %) and hydrogen peroxide (30 %). The metal content in canned tuna, mackerel and sardines ranged from 0.042 mg/kg (Cr) to 173 mg/kg (Ca), 0.024 mg/kg (Cr) to 200 mg/kg (Ca), 0.077 mg/kg (Cr) to 247.9 mg/kg (Ca), respectively. Cd and Pb concentrations in all samples were below the limit of detection (LOD) by FAAS. Ni concentrations were also below the LOD by FAAS except in one canned sardines sample. The content of studied metals in most canned fish samples decreased in the following order: Ca>Mg>Fe>Zn>Cu>Mn>Cr. Based on the results, it can be concluded that samples of canned fish (mackerel, sardines and tuna) contain sufficient concentrations of essential metals needed by the human body. Further analysis is needed to examine the adverse effect of metals from canned fish consumption on human health.

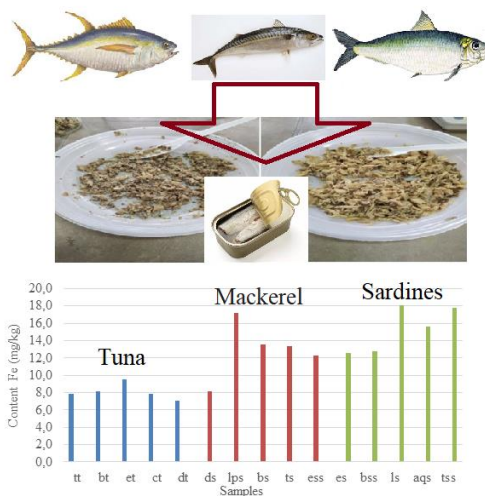

## NOVI ANALOZI REZVERATROLA KAO POTENCIJALNI INHIBITORI KOLINESTERAZA I ANTIOKSIDANSI

### NEW RESVERATROL ANALOGS AS POTENTIAL CHOLINESTERASE INHIBITORS AND ANTIOXIDANTS

**Lucija Živko, Milena Mlakić, Irena Škorić**

University of Zagreb Faculty of Chemical Engineering and Technology, Trg Marka Marulića 19, 10000 Zagreb, Croatia  
lzivko@fkit.unizg.hr

One of the most costly, deadly and burdensome diseases of the current century is Alzheimer's disease. Characterized as age-related, it stands as the primary contributor to dementia and is commonly identified in the elderly. In the latest approach to drug discovery, the focus is on creating new and potent anti-Alzheimer agents that possess substantial inhibitory potential against acetylcholinesterase (AChE) and butyrylcholinesterase (BChE) enzymes [1]. Based on earlier studies, thiazole derivatives of stilbene skeleton were identified as biologically active compounds [2], prompting the synthesis of new heterostilbenes as resveratrol analogs. Having that on mind, this research describes the synthesis of new 1,3-thiazolo-stilbenes and 2-thieno-stilbenes by the Wittig reaction, starting from the triphenylphosphonium salts and the corresponding aldehydes. The synthesis resulted in the mixture of *cis*- and *trans*- isomers of 1,3-thiazolo-stilbenes and 2-thieno-stilbenes, which were separated into pure configurational isomers by column and thin-layer chromatography. In order to confirm the structure, all synthesized compounds were fully spectroscopically characterized. The potential of the newly synthesized 1,3-thiazolo-stilbenes and 2-thieno-stilbenes to inhibit AChE and BChE was evaluated. The new compounds were also subjected to testing for potential antioxidant activity. Subsequently, one of the biologically active candidates underwent a molecular docking process to identify the non-covalent interactions that stabilize the enzyme-substrate complex.

[1] R. Hussain et al., *Molecules* 27 (2022) 6087.

[2] J. C. Liu et al., *Molecules* 27 (2022) 1009.

[3] M. Mlakić et al., *Molecules* 28 (2023) 3781.

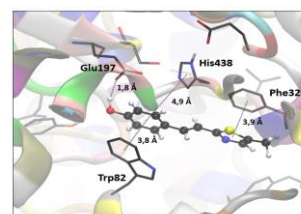
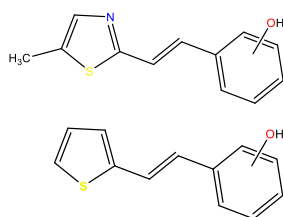
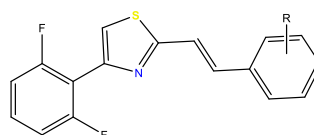
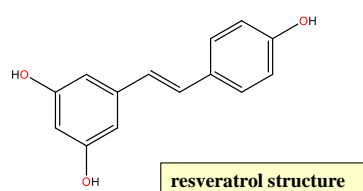



# **Razvoj materijala i proizvoda** *Materials and products development*

## KARAKTERIZACIJA PLGA KOPOLIMERA IZ INJEKCIJSKOG PROIZVODA S PRODULJENIM DJELOVANJEM

### CHARACTERIZATION OF PLGA COPOLYMER FROM LONG-ACTING INJECTABLE PRODUCT

**Tatjana Baković, Iva Erak, Martina Glavan, Tea Mihelj Josipović, Ivana Šoljić  
Jerbić**

Pliva Hrvatska d.o.o., Istraživanje i razvoj, Prilaz baruna Filipovića 25, 10000 Zagreb, Hrvatska  
tatjana.bakovic@pliva.com

Poli(laktid-*ko*-glikolid) (PLGA) kopolimeri su dobro poznati biorazgradivi poliesteri koji imaju široku primjenu kao modifikatori oslobađanja farmaceutskih injekcijskih proizvoda s produljenim oslobađanjem djelatne tvari na kontrolirani način [1,2]. U gotovi oblik lijeka uglavnom su ugrađeni kao složena smjesa djelatne tvari i drugih pomoćnih tvari. Stoga je pouzdana karakterizacija i identifikacija njihovih kritičnih svojstava koja mogu utjecati na mehanizam oslobađanja otežana zbog smetnji uzrokovanih prisutnošću drugih komponenti u gotovom obliku lijeka [3]. Cilj ovog rada bio je razviti i optimirati pouzdan postupak izolacije PLGA kopolimera iz farmaceutskog injekcijskog proizvoda s produljenim djelovanjem gdje su PLGA kopolimer i djelatna tvar otopljeni u organskom otapalu. Ključna fizikalno-kemijska svojstva određena na izoliranom PLGA su molekulske mase kopolimera, omjer monomera laktidnih i glikolidnih jedinica (L/G) i krajnje skupine te staklasti prijelaz ( $T_g$ ). Kako bi se validirao razvijeni postupak izolacije, rezultati karakterizacije dobiveni za izolirani PLGA uspoređeni su s onima dobivenim za PLGA kopolimer koji je korišten kao početna sirovina.

- [1] X. Shen et al., Front. Bioeng. Biotechnol. 8 (2020) 381-400.  
[2] S. N. Razaiean Shiadeh et al., Pharmaceutics 15 (2023) 1229-1146.  
[3] S. Skidmore et al., J. Control. Release 300 (2019) 174-184.

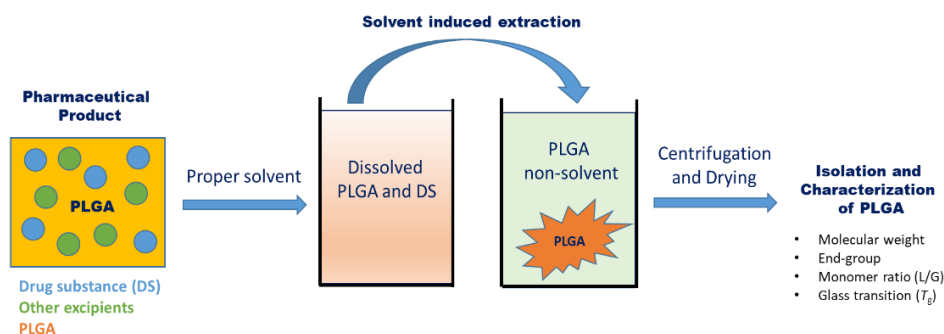

## BIODEGRADABLE BLENDS BASED ON POLY(3-HYDROXYBUTYRATE-CO-3-HYDROXYVALERATE) AND THERMOPLASTIC STARCH AS A PACKING MATERIALS

**Mihael Barišić<sup>1</sup>, Krešimir Stublić<sup>2</sup>, Dajana Kučić Grgić<sup>1</sup>, Vesna Ocelić Bulatović<sup>1</sup>**

<sup>1</sup>University of Zagreb Faculty of Chemical Engineering and Technology, Trg Marka Marulića 19, 10000 Zagreb, Croatia

<sup>2</sup>Aqua V.M.V d.o.o., kralja Zvonimira 98, 10000 Zagreb, Croatia  
mbarisic@fkit.unizg.hr

Polyhydroxyalkanoates (PHA) constitute a diverse group of biopolyesters with varied chemical structures. They are synthesized within numerous bacteria as intracellular reserves of carbon and energy in the cytoplasm. Their primary mechanical properties closely resemble those of synthetic plastics, including petroleum-based counterparts such as polyolefins. PHAs exhibit significant potential as an environmentally friendly substitute for conventional plastics due to their biodegradability, biocompatibility, and non-toxic nature. The commercially produced copolymer poly(3-hydroxybutyrate-co-3-hydroxyvalerate) (PHBV), while promising, faces challenges in practical applications due to its high melting point, elevated crystallinity, brittleness, and a narrow processing window. Overcoming issues related to low processability and brittleness involves exploring novel production processes, modifying chemical structures, and introducing innovations in formulations.

This study is focused on the preparation of biodegradable polymeric materials based on PHBV and thermoplastic starch (TPS) using a Brabender mixer. TPS was derived by plasticizing corn starch with 30 wt. % glycerol through two distinct methods: casting from a solution and compression molding. The investigation explored the impact of TPS on thermal, mechanical and barrier properties, providing insights into the morphological structure of PHBV/TPS blends. Morphology was analyzed using scanning electron microscopy (SEM). The polymer and blend structures were characterized using a combined technique of Fourier transform infrared spectroscopy and attenuated total reflection spectroscopy (FTIR-ATR). Mechanical properties were assessed through tensile testing, while thermal properties were examined via differential scanning calorimetry (DSC) and thermogravimetric analysis (TGA).

142

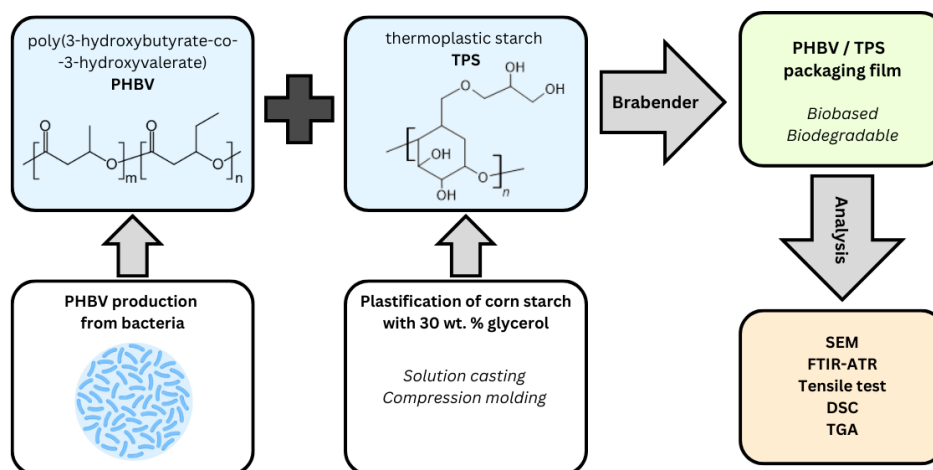

## PERHALOGENIRANI FENAZIN KAO DONOR HALOGENSKE VEZE U KOKRISTALIMA

## PERHALOGENATED PHENAZINE AS A HALOGEN BOND DONOR IN COCRYSTALS

**Nea Baus Topić<sup>1</sup>, Katarina Lisac<sup>2</sup>, Viktorija Medvarić<sup>3</sup>, Nikola Bedeković<sup>1</sup>, Vinko Nemec<sup>1</sup>, Nikola Cindro<sup>1</sup>, Dominik Cinčić<sup>1</sup>**

<sup>1</sup> Sveučilište u Zagrebu Prirodoslovno-matematički fakultet, Kemijski odsjek, Horvatovac 102a, 10000 Zagreb, Hrvatska

<sup>2</sup> Institut Ruđer Bošković, Zavod za istraživanje mora i okoliša, 10000 Zagreb, Hrvatska

<sup>3</sup> Leibniz Institute for Catalysis, Organocatalysis, Rostock, Njemačka  
nbaus@chem.pmf.hr

Najizučavaniji donori halogenske veze u organskim i metaloorganskim kokristalima su perhalogenirani jodbenzeni koji se odlikuju različitim brojem i razmještajem donorskih atoma joda u molekuli što omogućuje pripremu binarnih kristala sa željenim motivima povezivanja molekula u kristalu [1,2]. U kristalografskoj bazi podataka CSD [3] prisutno je najviše strukturnih podataka za višekomponentne sustave s 1,4-dijodtetrafluorbenzenom (680 unosa), a slijede ga 1,3,5-trifluor-2,4,6-trijodbenzen (329 unosa) te *orto* i *meta* izomeri dijodtetrafluorbenzena. U ovom istraživanju pripremljen je novi donor halogenske veze, 2,7-dijod-1,3,4,6,8,9-heksafluorfenazin (phphen), kao neželjeni produkt pri sintezi 4-jod-2,3,5,6-tetrafluoranilina, [4] te je okarakteriziran difrakcijskim metodama (XRPD i SCXRD), termičkim metodama (TGA i DSC), <sup>19</sup>F-NMR spektroskopijom, spektrometrijom masa visoke razlučivosti te računalnim metodama. Kako bi ispitali potencijal phphena kao donora halogenske veze, pripremljeni su njegovi kokristali s akceptorima različite veličine i geometrije, koji sadrže dušik, kisik i/ili sumpor (Slika 1.). Kokristalizacijom iz otopine pripremljeno je sedam kokristala u kojima su phphen i akceptor u stehiometrijskom omjeru 1:1 ili 1:2. Pripremljeni spojevi okarakterizirani su difrakcijom rentgenskog zračenja na jediničnom kristalu. Strukturnom analizom utvrđeno je da su u (bpy)(phphen), (dabco)(phphen), (hmt)(phphen) i (bzpy)<sub>2</sub>(phphen) dominantne halogenske veze N...I, dok su u ostala tri kokristala (btka)<sub>2</sub>(phphen), (sam)<sub>2</sub>(phphen) i [Cu(ovan)<sub>2</sub>(H<sub>2</sub>O)]<sub>2</sub>(phphen) dominantne halogenske veze O...I. Nadalje, u kokristalima stehiometrije 2:1, molekule su povezane halogenskim vezama u diskretne komplekse, a u kokristalima stehiometrije 1:1 u supramolekulske lance. Motivi i geometrija halogenskih veza u pripremljenim kokristalima u skladu su sa supramolekulskim motivima halogenskih veza u kokristalima perhalogeniranih jodbenzena.

- [1] G. Cavallo et al., Chem. Rev. 116 (2016) 2478-2601.  
 [2] V. Nemec et al., CrystEngComm 23 (2021) 3063-3083.  
 [3] C. R. Groom et al., Acta Cryst. Sect. B. Struct. Sci. B72 (2016) 171-179.  
 [4] L. V. Politanskaya et al., J. Fluor. Chem. 188 (2016) 85-98.

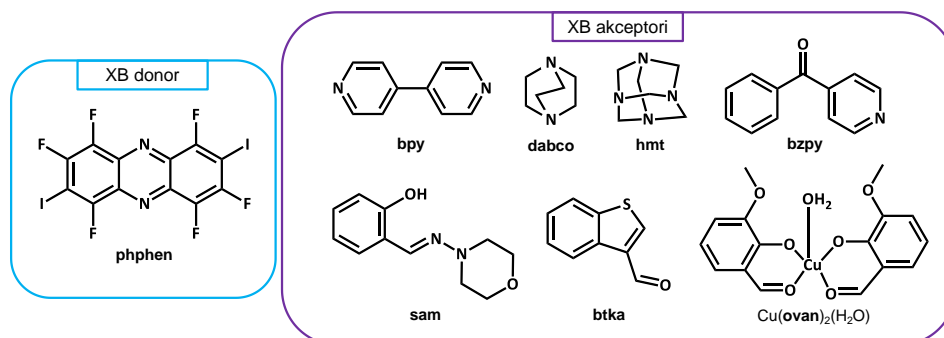

Slika 1. Molekule donora i akceptora korištenih za pripremu kokristala.

## OKSIDACIJSKI PRODUKTI LIFITEGRASTA DOBIVENI PRISILNOM RAZGRADNJOM

### OXIDATIVE DEGRADATION PRODUCTS OF LIFITEGRAST OBTAINED BY FORCED DEGRADATION

**Jadranka Buljević<sup>1</sup>, Ana Čikoš<sup>2</sup>, Daria Juretić Perišić<sup>3</sup>, Dean Marković<sup>1</sup>, Leo Štefan<sup>3</sup>**

<sup>1</sup>Sveučilište u Rijeci, Fakultet biotehnologije i razvoja lijekova, Radmile Matejčić 2, 51000 Rijeka, Hrvatska

<sup>2</sup>Institut Ruđer Bošković, Bijenička Cesta 54, 10000 Zagreb, Hrvatska

<sup>3</sup>Jadran Galenski Laboratorij, Svilno 20, 51000 Rijeka, Hrvatska

jadranka.buljevic5bj@gmail.com

Farmaceutska djelatna tvar lifitegrast, (*S*)-2-[2-(benzofuran-6-karbonil)-5,7-dikloro-1,2,3,4-tetrahidroizokinolin-6-karboksamido]-3-(metilsulfonilfenil)propanska kiselina, naznačen s (1) na slici 1 [1], kao LFA-1 antagonist pokazuje protuupalno djelovanje, a na tržištu je prisutan u formi kapi za oči pod nazivom Xiidra® [2]. Koristi se za liječenje sindroma suhog oka (keratokonjunktivitis sicca), odnosno multifaktorijalne bolesti oka i očne površine koja rezultira simptomima nelagode i poremećajem vida [3]. Zbog široke primjene i nedostatka relevantnih literaturnih podataka, prilikom plasiranja lifitegrasta na tržište važno je sagledati njegovu kemijsku stabilnost. U tome kontekstu istražen je oksidacijski potencijal raspada izlaganjem spoja (1) vodikovom peroksidu (H<sub>2</sub>O<sub>2</sub>) pri 25°C/60% RV, 40°C/75% RV i 50°C/75% RV kroz mjesec dana, tijekom čega su praćeni kritični parametri kvalitete poput ukupnog sadržaja i nastanka srodnih tvari. Nakon 30 dana došlo je do značajnog pada ukupnog sadržaja lifitegrasta (za 83%) uz formiranje nepoznatih degradacijskih produkata. U ponovljenoj studiji na većoj količini aktivne tvari primijenjeni su ekstremniji uvjeti razgradnje: trajanje 3 mjeseca uz 30% vodikov peroksid. Upotrebom kolonske i tankoslojne preparativne kromatografije izolirane su tri nove razgradne tvari (2), (3), (4), prikazane na slici 1, koje su identificirane i strukturno karakterizirane spektroskopijom nuklearne magnetske rezonancije (NMR). Strukture spojeva (2) i (4) su dodatno potvrđene masenom spektrometrijom (MS). Benzofuranski i izokinolinski heterociklički prstenovi u strukturi (1) su primarna mjesta oksidativne razgradnje.

144

- [1] CHMP. Committee for Medicinal Products for Human Use (2020) Withdrawal assessment report.  
 [2] Keating GM. *Drugs* (2017) 77(2) 201-208.  
 [3] National Center for Biotechnology Information. PubChem Compound Summary for CID 11965427, Lifitegrast (2023).

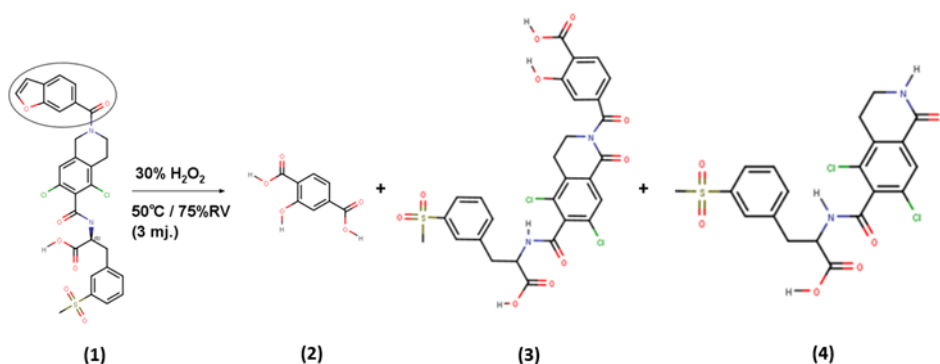

Slika 1. Razgradnja (1) u oksidativnim uvjetima na tri nove razgradne tvari (2), (3) i (4).

## KOKRISTALIZACIJA PERFLUORIRANIH JODBENZENA S IMINOM IZVEDENIM IZ 3-AMINOACETOFENONA I BENZO[B]TIOFEN-2-KARBALDEHIDA

### COCRYSTALLIZATION OF PERFLUORINATED IODOBENZENES WITH IMINE DERIVED FROM 3-AMINOACETOPHENONE AND BENZO[B]THIOPHENE-2- CARBOXALDEHYDE

**Petra Cindori, Nea Baus Topić, Dominik Cinčić**

Sveučilište u Zagrebu Prirodoslovno-matematički fakultet, Horvatovac 102a, 10000 Zagreb, Hrvatska  
pcindori.biol@pmf.hr

Halogenska veza je nekovalentna interakcija između elektrofilnog područja halogenog atoma (donora) i nukleofilnog područja iste ili neke druge molekule (akceptora) [1]. Intenzivno se proučava posljednja tri desetljeća u kristalnom inženjerstvu, a raznolikost istraživanih donora i akceptora halogenske veze u stalnom je porastu [2]. U ovom je radu ispitan potencijal karbonilne, iminske i tiofenske funkcijske skupine kao akceptora halogenske veze. Kondenzacijskom reakcijom benzo[b]tiofen-2-karbaldehida i 3-aminoacetofenona u tu je svrhu sintetiziran imin (1). Kristalizacijom iz otopine i mehanokemijskom sintezom ispitana je mogućnost kokristalizacije imina s odabranim donorima halogenske veze: 1,2-dijodtetrafluorbenzenom (12tfib), 1,3-dijodtetrafluorbenzenom (13tfib), 1,4-dijodtetrafluorbenzenom (14tfib) i 1,3,5-trijodtrifluorbenzenom (135tfib). Dobiveni produkti okarakterizirani su difrakcijom rendgenskog zračenja u polikristalnom uzorku, termogravimetrijskom analizom te razlikovnom pretražnom kalorimetrijom. Ukupno je dobiveno pet novih kristalnih produkata, a metodom difrakcije rendgenskog zračenja u jediničnom kristalu određene su molekulske i kristalne strukture triju kokristala: (1)2(12tfib), (1)2(14tfib), (1)2(135tfib). Strukturna analiza pokazala je da su molekule u sva tri kokristala međusobno povezane halogenskom vezom I...O, a u kokristalu (1)2(135tfib) dodatno su povezane i halogenskom vezom I...S. Relativna skraćenja halogenskih veza I...O u kokristalima su u rasponu od 14,0% do 16,9% s kutevima C-I...O od 172° do 175°. Halogenska veza I...S slabije je usmjerena, s relativnim skraćenjem 1,5% i kutem 152°. U svim kokristalima, donori halogenske veze ostvaruju maksimalno povezivanje s akceptorima, odnosno svi atomi joda donorâ sudjeluju u halogenskim vezama. Kroz ova tri primjera pokazano je kako je kisikov atom karbonilne skupine bolji akceptor halogenske veze od atoma sumpora tiofenske skupine, odnosno iminskog dušika.

145

[1] G. Cavallo et al., Chem. Rev. 116 (2016) 2478-2601.

[2] C. R. Groom et al., Acta Cryst. B72 (2016) 171-179.

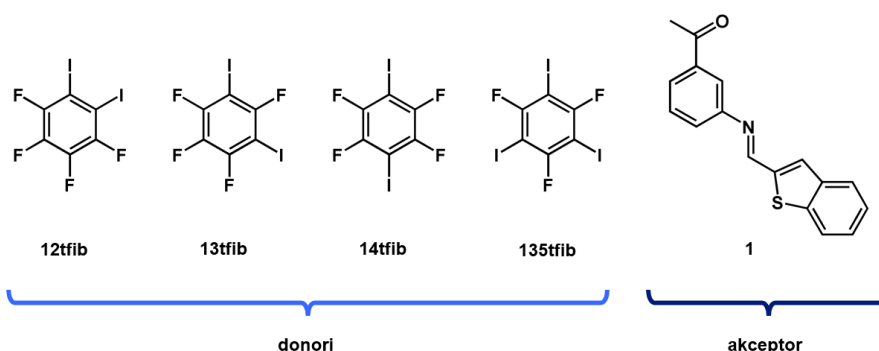

## PRIMJENA KOLAGENSKE PREVLAKE ZA BIOAKTIVACIJU POVRŠINE TITANIJEVOG IMPLANTATA

### APPLICATION OF COLLAGEN COATING FOR BIOACTIVATION OF THE TITANIUM IMPLANT SURFACE

**Martina Filipović<sup>1</sup>, Dajana Mikić<sup>1</sup>, Željka Petrović<sup>2</sup>, Ines Despotović<sup>3</sup>, Jozefina Katić<sup>1</sup>**

<sup>1</sup>Sveučilište u Zagrebu Fakultet kemijskog inženjerstva i tehnologije, Zavod za elektrokemiju,  
Trg Marka Marulića 19, 10000 Zagreb, Hrvatska

<sup>2</sup>Institut Ruđer Bošković, Zavod za kemiju materijala, Bijenička cesta 54, 10002 Zagreb, Hrvatska

<sup>3</sup>Institut Ruđer Bošković, Zavod za fizičku kemiju, Bijenička cesta 54, 10002 Zagreb, Hrvatska  
mfilipovi@fkit.unizg.hr

S globalnim starenjem populacije i zbog trauma, sportskih ozljeda i degenerativnih bolesti kod različitih demografskih skupina, povećava se potreba za implantnim materijalima među kojima su najčešće korišteni metalni implantni materijali, posebice titanij i njegove slitine [1,2]. Široko područje primjene uključuje ortopediju (npr. zamjena ili nadomjestak kostiju, umjetni zglobovi), dentalnu kirurgiju (zamjena zuba, poboljšavanje funkcionalnosti žvakanja ili za estetiku osmijeha), kardiologiju (ugradnja stentova) te općenito područje medicinskih implantata.

Neka od ključnih svojstava koja osiguravaju uspješnu ugradnju implantata u ljudsko tijelo su biokompatibilnost (osiguravanje dobre integracije s okolnim tkivom bez odbacivanja ili neželjenih reakcija) i bioaktivnost (sposobnost materijala za poticanje odgovarajućeg biološkog odgovora, kao što je rast koštanah stanica). Kako implantni materijali od titanija, iako pokazuju dobra biokompatibilna svojstva (uključujući korozivnu otpornost), pripadaju grupi bioinertnih materijala, za bioaktivaciju njihove površine koriste se različiti postupci modifikacije ili nanošenja prevlaka bioaktivnih tvari [3-6].

Kolagen je najvažniji protein u ljudskom tijelu koji izgrađuje kožu, zube, kosti, mišiće, ligamente i neke organe te predstavlja biokompatibilan i bioaktivan materijal s upotrebom u tkivnom inženjeringu. U ovom radu provedeno je ispitivanje modifikacije površine titanija funkcionalnim prevlakama kolagena kako bi se poboljšala osteokonduktivnost titanija što pozitivno utječe na biološki odgovor na međufaznoj granici implantni materijal/biološko okruženje i uspjeh implantacije. Uz strukturnu, morfološku i kemijsku karakterizaciju prevlaka kolagena (ATR-FTIR, SEM, EDS) posebno je ispitano antikorozijsko djelovanje prevlaka na titaniju koristeći elektrokemijske metode (LPR, EIS) pod *in vitro* uvjetima realne primjene.

146

- [1] M. Kaur and K. Singh. Mater. Sci. Eng. C 102 (2019) 844–862.
- [2] L. C. Zhang et al., Adv. Eng. Mater. 22 (2020) 1901253.
- [3] J. Katić et al., Coatings 9 (2019) 612.
- [4] M. Montazerian et al., Ceram. Int. 48 (2022) 8987-9005.
- [5] Ž. Petrović et al., Materials 15 (2022) 5127.
- [6] J. Katić et al., Coatings 13 (2023) 640.

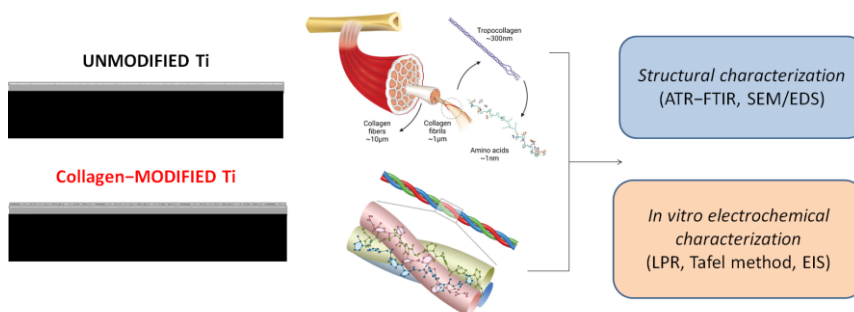

## UTJECAJ VRSTE MODIFIKACIJE NA TOČKU NUL-NABOJA I IZOELEKTRIČNU TOČKU NEUTRALNIH NANOČESTICA ŽELJEZA

### INFLUENCE OF THE TYPE OF MODIFICATION ON POINT ZERO-CHARGE AND ISOELECTRIC POINT OF ZEROVALENT IRON NANOPARTICLES

**Franjo Glibo, Andrea Špoljarić, Elvira Vidović**

Sveučilište u Zagrebu Fakultet kemijskog inženjerstva i tehnologije, Trg Marka Marulića 19, 10000 Zagreb, Hrvatska  
fglibo@fkit.unizg.hr

Uporaba neutralnih nanočestica željeza (engl. *zerovalent iron nanoparticles*, nZVI) u procesima pročišćavanja voda počela je njihovom primjenom u sanaciji i remedijaciji podzemnih voda i tla kontaminiranih različitim onečišćavateljima okoliša. Zbog njihovih nanodimenzija i svojstva magnetičnosti, vrlo često dolazi do stvaranja aglomerata što u konačnici smanjuje njihovu aktivnu površinu, a s time i njihovu reaktivnost. Osim toga, ograničena je i njihova mobilnost s obzirom da brzo sedimentiraju u vodenom mediju te to predstavlja veliki izazov za njihovu ekološku primjenu prilikom procesa uklanjanja onečišćavatelja iz vodenih tijela poput otpadnih voda. Stoga se mnoga istraživanja bave načinima modificiranja čestica, primjerice ligandima, surfaktantima, imobilizacijom i dopiranjem metalom kako bi uklonili nedostatke nZVI, a da pritom ne naruše njihovu reaktivnost i učinkovitost.[1]

Na temelju toga, u ovom radu cilj je bio istražiti utjecaj dvaju načina modificiranja nZVI na njihova površinska svojstva i stabilnost disperzije nZVI čestica. Jedan pristup bilo je stvaranje kompleksa sa odabranim ligandima: etilendiamintetraoctenom kiselinom (EDTA), piridin-2,6-dikarboksilnom kiselinom (PDCA) i natrijevim oksalatom ( $\text{Na}_2\text{C}_2\text{O}_4$ ) prilikom sinteze nZVI čestica. Drugi postupak modificiranja temelji se na adheziji nZVI čestica na čestice nosača, silicijevog/titanovog dioksida, tijekom sinteze nZVI čestica. Dodatno, pratila se stabilnost disperzije pri različitim pH vrijednostima kako bi se dobio uvid u utjecaj modificiranja na primjene u kiselim ili lužnatim uvjetima. Rezultati pokazuju kako ligandi ne utječu na promjenu površinskih svojstava čestica, primarno naboj, ali poboljšavaju stabilnost disperzije, pogotovo u kiselim i lužnatim uvjetima. Za razliku od njih, nosači imaju mnogo veći utjecaj na naboj čestica te uvelike pomažu stabilizaciji disperzije.

147

[1] D. S. Ken et al., Environ. Nanotechnol. Monit. 14 (2020) 100344.

Modificiranje ligandom:

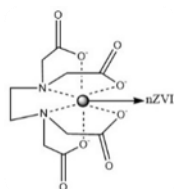

Imobilizacija na nosaču:

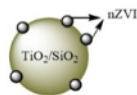

Utjecaj na vrijednost izoelektrične točke:

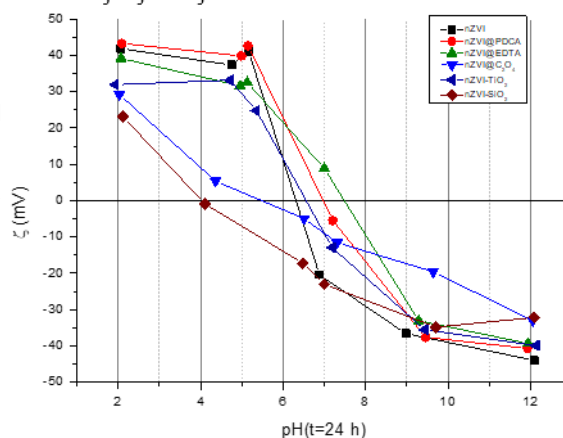



## KRUMPIROV ŠKROB: OTPAD ILI SIROVINA? POTATO STARCH: WASTE OR RAW MATERIAL?

**Nikolina Janton<sup>1</sup>, Gordana Matijašić<sup>2</sup>**

<sup>1</sup>Pliva d.o.o., Fizikalna karakterizacija, Prilaz baruna Filipovića 27, 10000 Zagreb, Hrvatska

<sup>2</sup>Sveučilište u Zagrebu Fakultet kemijskog inženjerstva i tehnologije, Trg Marka Marulića 19, 10000 Zagreb, Hrvatska  
janton.nikolina@gmail.com

Nowadays, most research is focused on reducing the negative impact of human activities on the environment. One possibility is to reduce the amount of waste generated during production. Since it is often difficult or impossible to completely avoid the generation of waste, it is necessary to dispose of it properly. The food industry belongs to the group of polluters. However, food production generates by-products with high nutritional value. They can potentially be used as new raw materials. One such by-product is white potato starch [1]. Starch is increasingly used in the drug formulation and some studies have mentioned it as an alternative raw material for the production of capsules in the pharmaceutical industry [2,3].

In this research, the development of filaments that will later be used for 3D printing of capsules using fused deposition modeling (FDM) was carried out. The filaments, the threads used for printing, were prepared by extruding potato starch at 100 °C. The hot melt extrusion was carried out in a twin-screw extruder with the addition of plasticizers such as glycerol and sorbitol. The morphological structure was determined using a scanning electron microscope and the thermal behavior of the material was determined using thermogravimetric analysis and differential scanning calorimetry.

- [1] N. Raj et al., *Int. J. Curr. Microbiol. Appl. Sci.* 9 (2020) 1718-1724.
- [2] Z. Misić et al., *J. Pharm. Sci.* 101 (2012) 4516-4528.
- [3] M. S. Sarwar et al., *Int. J. Biol. Macromol.* 241 (2023) 124598.



## CASE STUDY: FORENSIC EXAMINATION OF WORK OF ART

**Mia Kalanj, Marija Kovač, Bojan Miljević, Mihajlo Valuh, Snežana Vučetić**

University of Novi Sad, Faculty of Technology, Laboratory for Materials in Cultural Heritage (HERITAGELAB),  
Bulevar cara Lazara 1, 21000, Novi Sad, Serbia  
miakalanj@gmail.com

Forensic examination of the painting technology, applied pigments and binders represent crucial aspects of the multidisciplinary approach in the field of art characterization. The main goal of the examination is supporting conservators and restorers in cleaning, conservation and restoration procedures using characterization results as decision-making tools. In addition, forensic examinations play a significant role in identifying previous interventions or potential art forgeries. Considering the complexity of painted layers, used pigments and binders and the process of material degradation over time, the forensic analysis of works of art requires a careful approach and different characterization methods. These investigations are best carried out through the collaboration of scientists and conservators to achieve a complete characterization of the works of art. The main goal of this work was non-destructive characterization methods application in forensic examination, including X-ray fluorescence spectroscopy (XRF), Fourier transform infrared spectroscopy (FTIR), Raman spectroscopy, optical microscopy and VIS-spectrophotometry-colorimetry. These methods allow detailed examination of painting technology, pigments and binders without damaging the artwork. The results of this research contributed to establishing the methodology for the characterization of work of art that could be applied to similar works. This approach provides an efficient forensic analysis, thereby aiding the processes of cultural heritage preservation.

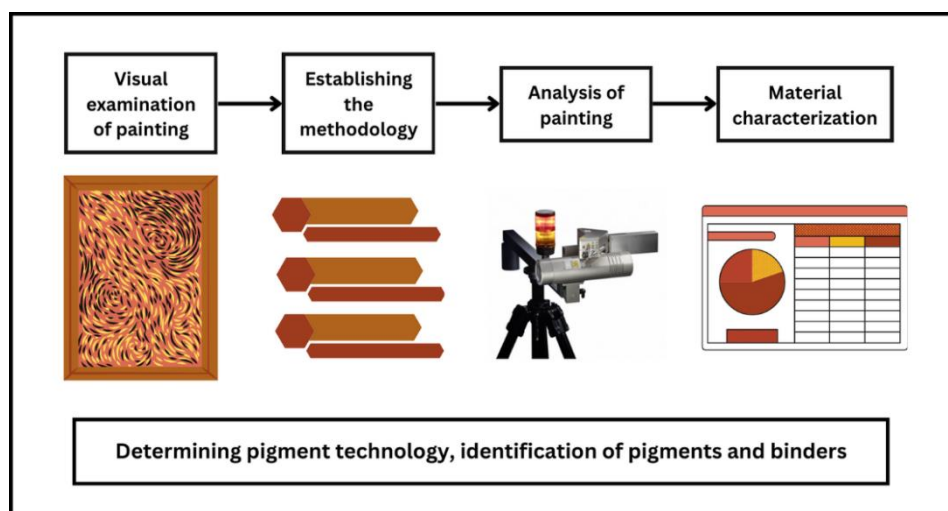

## OPTIMIRANJE 3D-ISPISA: KARAKTERIZACIJA EPOKSI/AKRILATNE SMOLE

### OPTIMIZATION OF 3D PRINTING: CHARACTERIZATION OF EPOXY/ACRYLATE RESIN

**Tibor Borna Kesić, Ivan Karlo Cingesar, Domagoj Vrsaljko**

Sveučilište u Zagrebu Fakultet kemijskog inženjerstva i tehnologije, Trg Marka Marulića 19, 10000 Zagreb, Hrvatska  
tkesic@fkit.unizg.hr

Cilj ovog istraživanja je ispitati utjecaj kuta ispisa i naknadne obrade u komori za očvršćivanje na primjenska svojstva 3D-ispisanih modela izrađenih od smole Prima™ Creator value STANDARD CLEAR, s posebnim naglaskom na mehanička, kemijska i toplinska svojstva materijala. Modeli epruveta i pločica za bubrenje su dizajnirani korištenjem programa Fusion 360 i 3D-ispisani na uređaju Anycubic Photon M3 koji koristi DLP tehnologiju. Modeli su 3D-ispisani pod kutovima ispisa  $0^\circ$ ,  $45^\circ$  i  $90^\circ$  u odnosu na podlogu za ispis te su naknadno obrađeni intervalima zračenja u 405 nm komori od 0, 5 i 15 minuta. Mehanička svojstva su ispitana vlačnim testom, kemijska svojstva su analizirana testom bubrenja u acetonu, metanolu i vodi te infracrvenom spektroskopijom, dok su toplinska svojstva istražena razlikovnom pretražnom kalorimetrijom. Rezultati eksperimenata ukazuju na utjecaj kuta ispisa i naknadnog očvršćivanja na svojstva materijala, pri čemu naknadno očvršćeni uzorci postaju krući i manje žilavi. Kut ispisa od  $0^\circ$  rezultira nižim istezanjem i većom čvrstoćom. Agresivna otapala, poput acetona i metanola, uzrokuju bubrenje i degradaciju uzoraka, no naknadno očvršćivanje smanjuje intenzitet bubrenja. Infracrvena spektrometrija otkriva promjene u strukturi molekula očvršćivanjem, dok termogrami dobiveni razlikovnom pretražnom kalorimetrijom ne pružaju jasne dokaze o utjecaju kuta ispisa na toplinska svojstva. Umrežavanje nakon ispisa blago povišuje temperaturu staklastog prijelaza.

Ovaj rad sufinancirala je Hrvatska zaklada za znanost projektima IP-2022-10-8004 (INDIGO) i DOK-2020-01-8955.

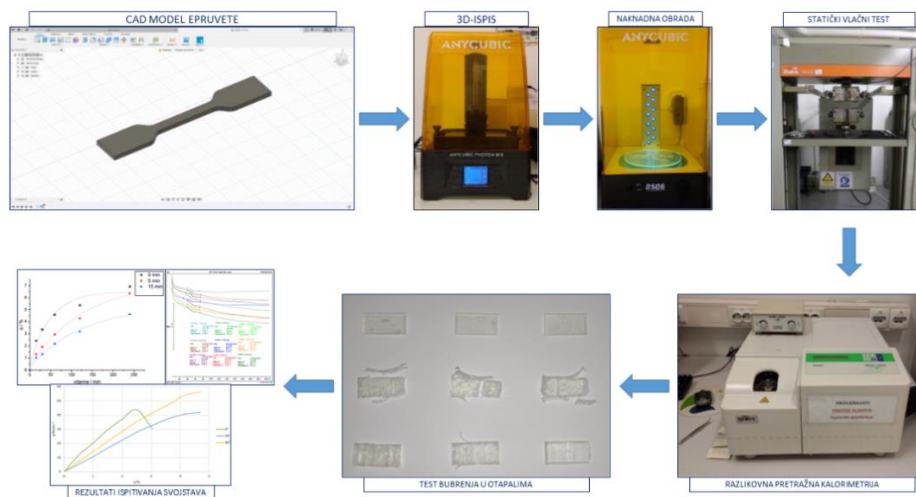

## SYNTHESIS AND PHYSICAL CHARACTERIZATION OF NOVEL API COCRYSTALS

**Ivana Landeka<sup>1</sup>, Antonela Bikić<sup>1</sup>, Eva Josić<sup>2</sup>**

<sup>1</sup>Teva API R&D, Prilaz baruna Filipovića 25, 10 000 Zagreb, Croatia

<sup>2</sup>University of Zagreb Faculty of Science, Horvatovac 102a, 10 000 Zagreb, Croatia  
Ivana.Landeka@pliva.com

In this work, an active pharmaceutical ingredient (API) has been studied in cocrystallization experiments with coformers generally recognized as safe (GRAS) [1]. A special challenge was the fact that API is in the form of a salt. For the selection of appropriate coformers, COSMOtherm software calculations and the pKa rule were used [2].

Although in principle a cocrystal is defined in solid state, it has been shown that the tendency of a given API to form cocrystals with a coformer is strongly correlated with energetic properties of the liquid mixture of the API and coformer. The excess enthalpy, Hex (a major factor for H-bonding interactions) between API and coformer mixture, as compared to pure components, reflects the tendency of those two compounds to cocrystallize. [3]

Regarding the fact when the API is a salt and high influence of counter anion to its sigma profile, COSMOtherm turned out to be a useful tool for coformer selection.

Mechanochemical synthesis and slurry experiments resulted in five new cocrystals. The obtained products were characterized by powder X-ray diffraction, thermal and spectroscopic measurements. For five most stable cocrystals, NMR and HPLC analysis determined the ratio of API, counter-ion, and coformer. All physical properties were compared with known polymorph of API salt.

[1] <https://www.fda.gov/food/generally-recognized-safe-gras/gras-substances-scogs-database> (accessed 12.1.2024.)

[2] A. J. Cruz-Cabeza, CrystEngComm 14 (2012) 6362–6365.

[3] S. Kumar and A. Nanda, Indian J. Pharm Sci. 78(6) (2017) 858-871.

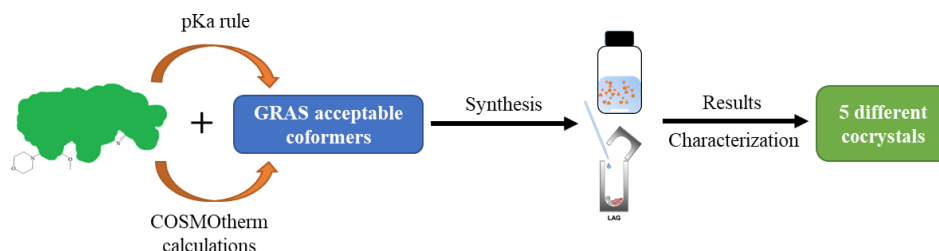

# ELEKTROKEMIJSKA KARAKTERIZACIJA FOTOKATALIZATORA ZA PRIMJENU U RAZGRADNJI PERFLUORIRANIH KARBOKSILNIH KISELINA

## ELECTROCHEMICAL CHARACTERISATION OF PHOTOCATALYST FOR PERFLUORATED ACIDIC SUBSTANCES DEGRADATION

**Tadea Lažeta<sup>1</sup>, Marija Labudović<sup>1</sup>, Gabrijele Radić<sup>1</sup>, Josipa Papac Zjačić<sup>1</sup>, Elza Štefančić<sup>1</sup>, Andraž Šuligoj<sup>2</sup>, Marin Popović<sup>1</sup>, Hrvoje Kušić<sup>1</sup>**

<sup>1</sup>Sveučilište u Zagrebu Fakultet kemijskog inženjerstva i tehnologije, Trg Marka Marulića 19, 10000 Zagreb, Hrvatska

<sup>2</sup>National Institute of Chemistry, Hajdrihova 19, 1001 Ljubljana, Slovenija

tlazeta@fkit.unizg.hr, mlabudovi@fkit.unizg.hr

Perfluorirani organski spojevi u posljednja dva desetljeća privlače posebnu pozornost i izazivaju zabrinutost zbog utjecaja na okoliš i ljudsko zdravlje. Posebno zabrinjava činjenica da su ovi spojevi izrazito stabilni i skloni bioakumulaciji. Smatra se da su tijekom njihove proizvodnje, distribucije i odlaganja velike količine perfluoriranih alkilnih spojeva (PFAS) dospjele u okoliš. Njihova prisutnost zabilježena je u oceanima te površinskim i podzemnim vodama gdje su utvrđene količine od pg/L do µg/L. Postoji nekoliko načina uklanjanja PFAS-a iz vodenih medija poput fizikalnih, elektrokemijskih ili sonokemijskih metoda te foto-procesa. Najpoželjnije metode su one kod kojih dolazi do pucanja C-F veze, odnosno do degradacije PFAS-a u manje toksične spojeve. Jedna od takvih metoda je i fotokatalitički proces.

U ovom radu provedena je elektrokemijska karakterizacija fotokatalizatora BiVO<sub>4</sub> modificiranog s Fe<sub>2</sub>O<sub>3</sub> i Ag te fotokatalizatora temeljenog na grafitnom karbonitridu s ciljem njihove primjene u razgradnji PFAS-a. Metode korištene za karakterizaciju fotokatalizatora su linearna polarizacija, elektrokemijska impedancijska spektroskopija, kronoamperometrija te praćenje potencijala otvorenog kruga u vremenu. Ispitivanje je provedeno u 0,5 mol dm<sup>-3</sup> otopini Na<sub>2</sub>SO<sub>4</sub> i otopini Na<sub>2</sub>SO<sub>4</sub>/PFAS-a.

Ovaj rad je izrađen u sklopu projekta IPS-2022-02-4780, Fotokatalitička razgradnja perfluoriranih spojeva u vodi uz Sunčevo zračenje (SoAPperF), HRZZ i ARRS.

152

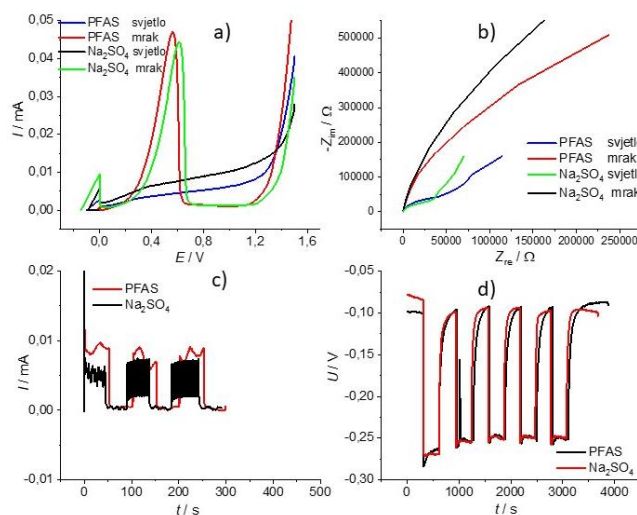

Slika 1. Karakterizacija BiVO<sub>4</sub> modificiranog s 30% Fe<sub>2</sub>O<sub>3</sub> i 6% Ag metodom a) linearne polarizacije, b) elektrokemijske impedancijske spektroskopije, c) kronoamperetrije i d) praćenjem potencijala otvorenog kruga.

## ISPITIVANJE SVOJSTAVA OTPADNE LJUSKE ORAŠASTIH PLODOVA I NJIHOVIH KOMPOZITA

### INVESTIGATION OF PROPERTIES OF WASTE NUTSHELL AND ITS COMPOSITES

**Kristijana Lopac-Škrinjar, Filip Brleković, Katarina Mužina**

Sveučilište u Zagrebu Fakultet kemijskog inženjerstva i tehnologije, Trg Marka Marulića 19, 10000 Zagreb, Hrvatska  
klopacskr@fkit.unizg.hr

Ljuske orašastih plodova jedan su od poljoprivrednih nusproizvoda čija najčešća sudbina je upotreba kao gorivo. Novi smjer razvoja materijala je upućen ka naprednim i ekološki prihvatljivim tehnologijama u kojima je poželjno koristiti otpadne materijale poput ljuski orašastih plodova kako bi se dobili novi materijali visokih dodanih vrijednosti. Najjednostavniji načini dobivanja materijala već spomenutih specifikacija i svojstava je kreiranjem kompozitnih materijala upotrebom jedne ili više otpadnih sirovina. Ljuske orašastih plodova kao lignocelulozni materijali pokazuju zanimljivu mogućnost primjene u građevinskim materijalima u kombinaciji s nekim od mineralnih veziva, a jedno od mineralnih veziva s minimalnim utjecajem na okoliš te visokom ekološkom prihvatljivošću su geopolimeri. Geopolimeri su alumosilikatni materijali koji očvršćuju zamješavanjem alkalnih otopina alkalijskih hidroksida i njihovih topivih silikata te čvrstih prekursora alumosilikatnog sastava. Kako su ljuske orašastih plodova kao prirodni materijali kompleksnog sastava, najčešće je potrebna neka vrsta predobrade kako bi se uklonile nepoželjne sastavnice koje mogu ometati uspješno dobivanje kompozitnih materijala. U ovome radu ispitan je utjecaj predobrade s pomoću natrijevog i kalcijevog hidroksida na svojstva otpadne ljuske badema i lješnjaka upotrebom infracrvene spektroskopije s Fourierovim transformacijama (FTIR) te određivanje površinskih svojstava mjerenjem kontaktnog kuta. Različito pripremljenim geopolimerima također su određena površinska svojstva. Izračunavanjem adhezijskih parametara odabrani su najbolji uvjeti predobrade ljuske i vrste geopolimera za pripremu kompozita. Rezultati adhezijskih parametara ukazuju na najbolju predobradu otopinom 6% NaOH na 2,5 h na 80 °C te pripremom kompozita s geopolimerom dobivenog zamješavanjem metakaolina i kalijevih aktivacijskih otopina. Pripremljenim kompozitima su određena mehanička i toplinska svojstva koji ukazuju na poboljšanje svojstava s predobradom.

153

[1] F. Brleković et al., J. Compos. Sci. 8 (2024) 26.

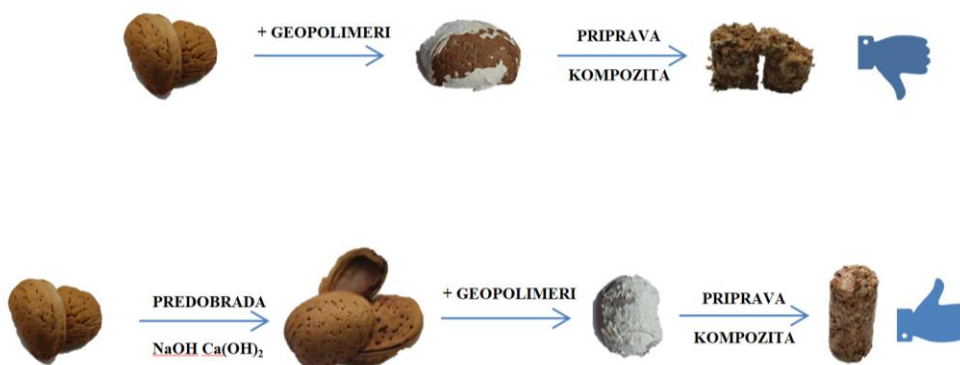

## UROTROPIN I SRODNI SPOJEVI KAO AKCEPTORI HALOGENSKE VEZE

### UROTROPINE AND RELATED COMPOUNDS AS HALOGEN BOND ACCEPTORS

**Antonio Magnabosco, Vinko Nemeć, Nea Baus Topić, Vladimir Stilinović,  
Dominik Cinčić**

Sveučilište u Zagrebu Prirodoslovno-matematički fakultet, Kemijski odsjek, Horvatovac 102a, 10 000 Zagreb  
amagnabosco@chem.pmf.hr

Tipični primjer alifatskog poliamina koji se često rabi kao gradivni blok u kristalnom inženjerstvu je heksametilentaamin (urotropin). Riječ je o približno sfernoj policikličkoj molekuli (simetrijske grupe točke  $T_d$ ) s tetraedarskim razmještanjem dušikovih atoma koja može poslužiti kao potencijalni tetratopični akceptor vodikove veze i kao takva dovesti do nastanka trodimenzijskih supramolekulskih struktura dijamantoidne topologije. Analogno potencijalu za uspostavljanje vodikovih veza, urotropin može biti akceptor i halogenskih veza. Dapače, prvi puta se kao akceptor halogenske veze javlja već u istraživanjima O. Hassela 1970.[1] Stoga urotropin danas pobuđuje interes u kristalnom inženjerstvu, primjerice za dizajn poroznih molekulskih kristala.[2] Izuzevši urotropin, srodni spojevi su vrlo slabo proučeni.

Svrha je ovog istraživanja bila usporediti ponašanje urotropina (hmta) kao akceptora halogenske veze s njegovim fosfa-analogom (1,3,5-triaza-7-fosfaadamantan) (phmta) simetrije  $C_{3v}$  i višim homologom [1<sup>4</sup>,2<sup>2</sup>]adamanzanom (1,3,6,8-tetraazatriciklo[4.4.1.1<sup>3,8</sup>]dodekan) (adz) simetrije  $D_2$ . Kako bi to izučili navedeni su spojevi kokristalizirani s 1,2-dijodtetrafluorbenzenom (12tfib), 1,3-dijodtetrafluorbenzenom (13tfib), 1,4-dijodtetrafluorbenzenom (14tfib) te 1,3,5-trijodtrifluorbenzenom (135tfib) čime je pripravljeno 11 novih kokristala. U ovome će priopćenju biti prikazane razlike u supramolekulskim strukturama dobivenih materijala koje proizlaze iz razlika u molekulskoj strukturi akceptorskih molekula.

[1] O. Hassel and T. Dahl, Acta Chem. Scand. 24 (1970) 377-383.

[2] K. Raatikainen et al., Chem. Sci. 3 (2012) 1235-1239.

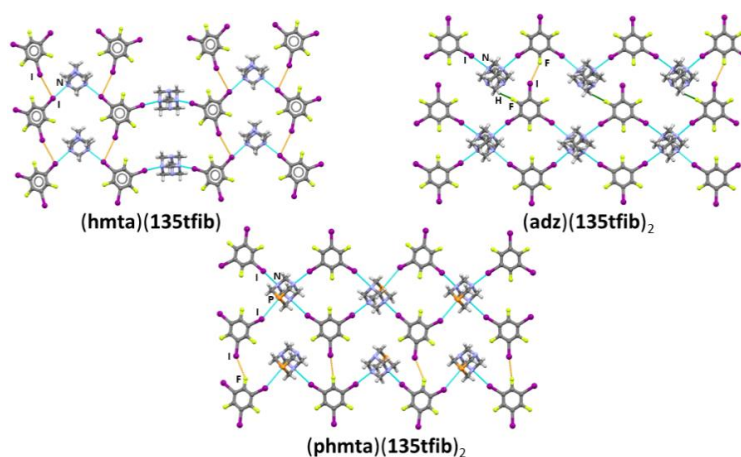

## CHARACTERIZATION AND APPLICATION OF LITMUS-BASED pH SENSORS IN 3D PRINTED MICROREACTOR SYSTEMS

**Marijan-Pere Marković, Ivan Karlo Cingesar, Elizabeta Forjan,  
Petar Kassal, Domagoj Vrsaljko**

University of Zagreb Faculty of Chemical Engineering and Technology, Trg Marka Marulića 19, 10000 Zagreb,  
Croatia  
mmarkovi1@fkit.unizg.hr

Monitoring the conditions of the chemical reaction in the reactors enables a higher yield and lower energy consumption. The primary goal was the production of pH sensor films using litmus indicators immobilized in a silane film and the coating of microreactor channels with this film. Fused filament fabrication (FFF) technology with poly(ethylene terephthalate) glycol (PETG) filaments was used to produce the microreactors.

By applying a sol-gel method, it is possible to produce thin sensor films. Tetraethoxysilane (TEOS) and phenyltrimethoxysilane (FTMS) were used as sol-gel precursors with the litmus indicator immobilized in the silane film. An RGB analyzer was used to detect color changes in the microreactor channels. The films were additionally characterized by the contact angle method with water and diiodomethane and by Fourier transform infrared spectroscopy (FTIR).

Various flow regimes were tested in the microreactor. First, acid and alkali solutions were circulated through the channels of the microreactor, followed by simultaneous introduction in separate streams. RGB analysis revealed that the color changes occurred usually within one minute depending on the pH of the solution. The color changes were visible to the naked eye and reversible, proving that the sensor films are reusable.

Croatian Science Foundation has supported this work under the projects DOK-2020-01-8955, DOK-2021-02-5999, and IP-2022-10-8004.

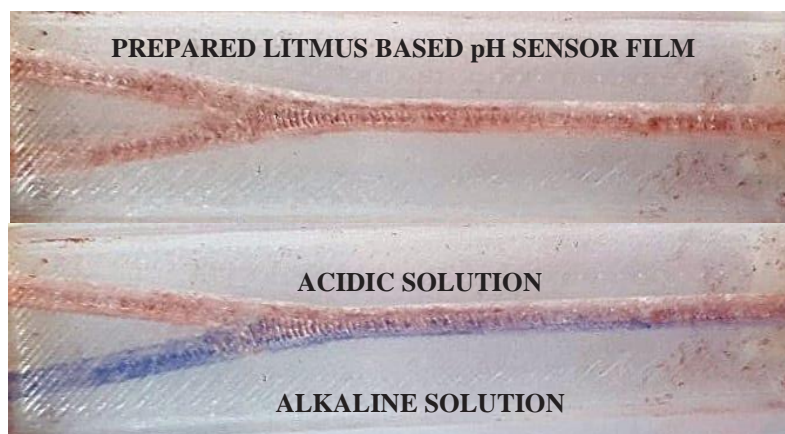



## INKJET TISKANI VODLJIVI I SAVITLJIVI FILMOVI NA OSNOVI POLI(3,4-ETILENDIOKSITIOFENA)

### INKJET PRINTED CONDUCTIVE AND FLEXIBLE FILMS BASED ON POLY(3,4-ETHYLENEDIOXYTHIOPHENE)

**Katarina Marković, Stela Sabo, Leona Zagorec, Antonijo Ćosić, Marin Božičević, Zvonimir Katančić**

Sveučilište u Zagrebu Fakultet kemijskog inženjerstva i tehnologije, Trg Marka Marulića 19, 10000 Zagreb, Hrvatska  
kmarkovic@fkit.unizg.hr, ssabo@fkit.unizg.hr, lzagorec@fkit.unizg.hr

Zbog svojih iznimnih karakteristika, kao što su visoka toplinska, i okolišna stabilnost i dobra vodljivost vodljivi polimeri sve više privlače pažnju u industrijskoj primjeni i znanstvenim istraživanjima [1]. Poli(3,4-etilendioksitiofen) (PEDOT) ističe se kao jedan od glavnih predstavnika vodljivih polimera zbog svoje kemijske stabilnosti, visoke vodljivost i biokompatibilnosti uz jednostavnu sintezu kemijskim ili elektrokemijskim metodama [2]. Radikalna polimerizacija uz prijenos atoma (ATRP) je kontrolirana polimerizacija koja se koristila u ovom istraživanju kako bi se upravljalo molekulskom masom, disperznosti te samim svojstvima konačnih produkata [3]. S obzirom da PEDOT sam po sebi nije pogodan za ovakvu vrstu polimerizacije, početni korak bila je sinteza modificiranog PEDOT-a. To se postiže oksidacijskom kopolimerizacijom monomera 3,4-etilendioksitiofena (EDOT) i monomera 2-(tiofen-3-il)etil 2-bromo-2-metilpropanoata (ThBr). ThBr dijeli tiofensku grupu s EDOT-om, ali je dodana funkcionalna skupina iz alfa-bromoisobutiril bromida (BiBB) kako bi bio pogodan za ATRP sintezu, koja se odvija na alkil-halidnoj grupi [4]. Na kraju, poli(etilenglikol) metakrilat koristi se kao ATRP monomer kako bi se poboljšala željena mehanička svojstva. Grane PEG-MMA se cijepu na ThBr dio polimera kako bi se poboljšala rastezljivost i postiglo samozacjeljivanje putem vodikovih veza. U istraživanju su optimirani uvjeti ATRP sinteze, uključujući vrijeme reakcije i temperaturu, a sintetizirani produkti su karakterizirani pomoću NMR-a, FTIR-a, TGA-e i DSC-a. Dobiveni polimeri su *inkjet* tehnikom tiskani na savitljive poliuretanske podloge te su im ispitana mehanička svojstva i vodljivost.

156

- [1] M. N. Gueye et al., Prog. Mater. Sci. 108 (2020) 100616.
- [2] Y. Wang, J. Phys.: Conf. Ser. 152 (2009) 012023.
- [3] G. Szczepaniak et al., Acc. Chem. Res. 54 (2021) 1779-1790.
- [4] K. Parkatzidis et al., Chem 6 (2020) 1575-1588.

Ovaj rad je financirala Hrvatska zaklada za znanost projektom UIP-2019-04-8304.

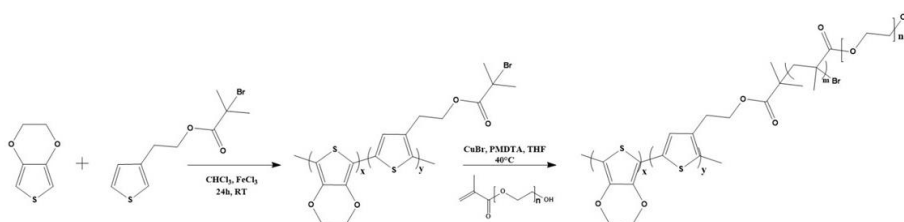

Shematski prikaz reakcije sinteze vodljivog graft kopolimera PEDOT-g-PEG-a

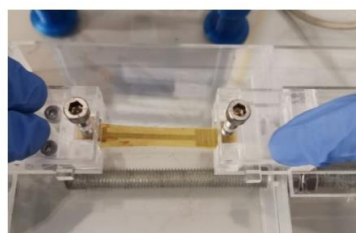

## BIODEGRADABLE BLENDS BASED ON POLYHYDROXYALKANOATE

**Nika Medved, Dajana Kučić Grgić, Vesna Očelić Bulatović**

University of Zagreb Faculty of Chemical Engineering and Technology, Trg Marka Marulića 19, 10000 Zagreb, Croatia  
nmedved@fkit.unizg.hr

In recent times, environmental protection and the promotion of pollution reduction have become very important. One of the main sources of pollution is conventional plastic, which is not biodegradable in the environment. The accumulation of conventional plastic causes considerable environmental damage and impairs the quality of life. In the search for new and innovative materials that could replace conventional plastics, polyhydroxyalkanoates (PHA) stand out. PHA belongs to a group of microbial polyesters that are synthesized by microorganisms. As environmental pollution caused by the accumulation of plastics has reached alarming levels, PHA's properties make it an excellent alternative to replace conventional plastics. PHA is seen as a potential candidate that could help reduce greenhouse gas emissions and advance the fields of biotechnology, medicine and industry in general. Properties such as biodegradability and biocompatibility make this type of material a sustainable solution that promotes sustainable development policies and awareness. The main obstacle to the globalization of PHA production is the cost of production. For this reason, it is necessary to focus on research aimed at the production processes and the improvement of physical and mechanical properties through different modification methods. By emphasizing these aspects, the cost efficiency of the production process of this type of polyester would be achieved.

The aim of this research is to investigate the properties of biodegradable polymers. The main focus is on PHA, but the properties of other biodegradable polymers such as polylactic acid (PLA), polycaprolactone (PCL) and thermoplastic starch (TPS) and their polymer blends with PHA were also analyzed. Thermal, mechanical and surface properties as well as changes in the chemical composition of these polymers and blends were investigated with the aim of better understanding their application as environmentally friendly and sustainable materials for the future. The research on polymer blends such as PHA/PLA, PHA/PCL and PHA/TPS shows their hydrophilic and hydrophobic properties, physical changes, semi-crystallinity, complex crystallization structure and improvement of mechanical properties of PHA/PLA and PHA/PCL blends.

157

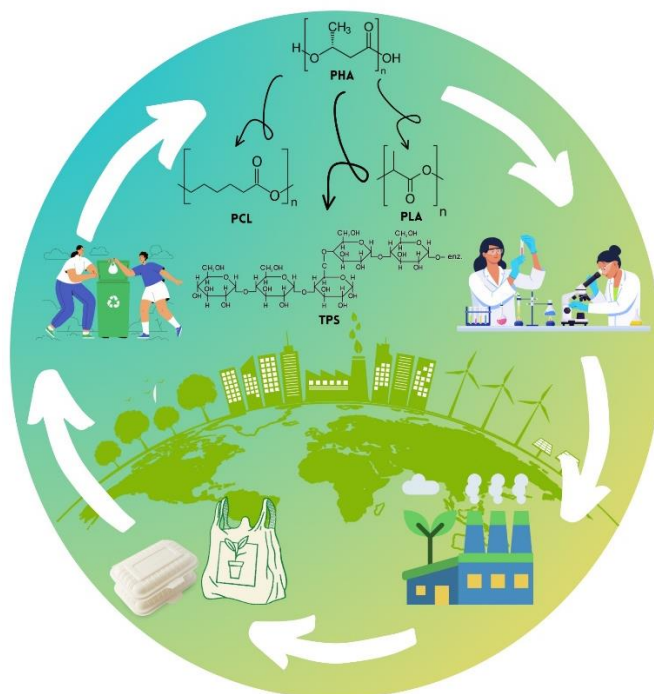

## MEHANOKEMIJSKA SINTEZA IZOFTALNIH DVOMETALNIH MOF-74 HOMOLOGA

### MECHANOCHEMICAL SYNTHESIS OF ISOPHTHALIC BIMETALLIC MOF-74 HOMOLOGUE

**Dora Mendaš<sup>1</sup>, Katarina Lisac<sup>2</sup>, Valentina Martinez<sup>2</sup>, Natalija Pantalon Juraj<sup>2</sup>,  
Luka Pavić<sup>2</sup>, Jurica Jurec<sup>2</sup>, Dijana Žilić<sup>2</sup>, Krunoslav Užarević<sup>2</sup>**

<sup>1</sup>Sveučilište u Zagrebu Fakultet kemijskog inženjersva i tehnologije, Trg Marka Marulića 19, 10000 Zagreb, Hrvatska  
<sup>2</sup>Institut Ruđer Bošković, Bijenička cesta 54, 10000 Zagreb, Hrvatska  
dmendas@fkit.unizg.hr

Metalo-organske mreže (MOF-ovi) su porozni koordinacijski polimeri koji se sastoje od metalnih centara premoštenih organskim molekulama. Ovi materijali su u fokusu akademske zajednice i industrije zbog svojih jedinstvenih svojstava koja proizlaze iz njihovih poroznih struktura te velikog potencijala za primjenu. Naročitu pažnju privlače MOF-74 materijali izgrađeni od dvovalentnih kationa d-bloka i 2,5-dihidroksitereftalne kiseline (dhia), u čijoj sačastoj strukturi se metalni kationi nalaze u neposrednoj blizini unutar 1D okso-lanaca. Zbog ove blizine metala je sinteza višemetallnih MOF-74 materijala predmet dugogodišnjih sintetskih istraživanja, ali otopinska sinteza se pokazala nedostatnom jer ne postoji kontrola u smještaju i količini centara pojedinih metalnih vrsta, dajući višemetallne MOF-74 materijale s do 10 različitih metalnih centara, ali s nehomogenom raspodjelom metala i kristalitima različitih sastava u istom produktu. Nedavno je pokazano da mehanokemijska sinteza rješava problem nehomogenosti, dugotrajnosti kemijske reakcije i eliminira potrebu štetnih otapala s visokim vrelištima, iznad 100°C, poput DMF-a.[1] Kod višemetallnih MOF-74 materijala, mehanokemijska sinteza ide u dva stupnja i omogućuje značajno poboljšanje u kontroli stehiometrije i raspodjele dva različita metala u MOF-u,[2] dajući niz različitih materijala s naprednim magnetskim i katalitičkim svojstvima koja proizlaze iz porozne strukture, prirode metalnih centara i organskih linkera.[1,3] Osim tipičnog MOF-74 materijala veliki potencijal leži i u dhia homologu (4,6-dihidroksiizoftalna kiselina) ovog materijala koji do sada nije mehanokemijski pripremljen niti su istraženi njegovi dvometalni analozi. Ovdje pokazujemo niz dvometallnih nikal-mangan MOF materijala izvedenih iz dhia-e koristeći mljevenje na sobnoj i na povišenoj temperaturi te različite metalne prekursore (M(II) acetati ili 1:1 M(II)-dhia intermedijeri (M=Ni, Mn)). Dodatno smo odredili i kristalne strukture navedenih međuprodukata i proučavali magnetska svojstva intermedijera i odabranih MOF-ova spektroskopijskim elektronske spinske rezonancije (ESR).

158

- [1] S. Muratović et al., *Inorg. Chem.* 61 (2022) 18181-18192.  
[2] G. Ayoub et al., *Chem. Mater.* 31 (2019) 5494-5501.  
[3] T. Stolar et al., *ACS Appl. Mater. Interfaces* 13 (2021) 3070-3077.

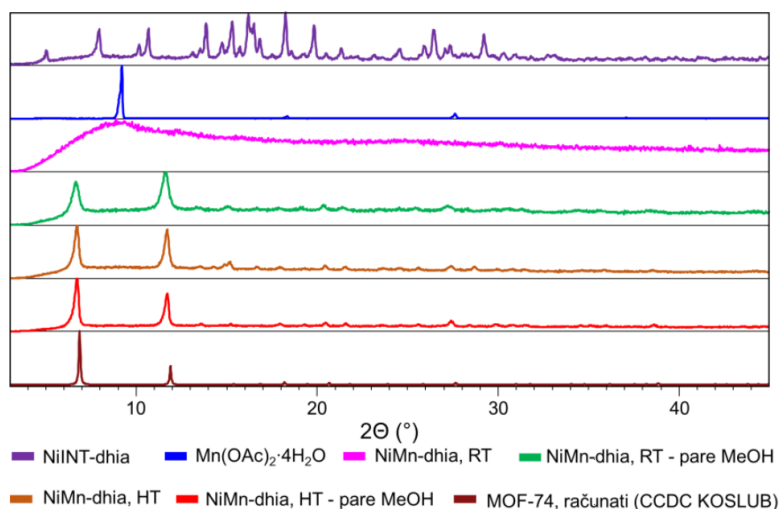

Slika 1. Difraktogrami praha za niz višemetallnih nikal-mangan MOF-74 materijala baziranih na izoftalnom dhia ligandu pripremljenih mehanokemijskim metodama

## THE POWER OF WEAK INTERMOLECULAR INTERACTIONS IN ACHIEVING MECHANICAL RESPONSES OF CRYSTALLINE COORDINATION POLYMERS OF CADMIUM(II)

**Fran Miletić, Mateja Pisačić, Marijana Đaković**

University of Zagreb Faculty of Science, Department of Chemistry, Horvatovac 102a, 10000 Zagreb, Croatia  
fmiletic.chem@pmf.hr

The structure of crystals has been discovered decades ago and it has been for a long time perceived as rigid and mostly unchanging. But many confuse the organised, long-range ordered structure of crystals with their microscopic and macroscopic mechanical properties by labelling all crystals as brittle materials and those with fixed structure. Recent investigations into organic and metal-organic compounds have revealed intriguing responses to various physical (thermal, light, or mechanical) stimuli [1–3]. Notably, certain cadmium(II) and copper(II) compounds have demonstrated plastic and elastic behaviours in response to mechanical strain [4–8].

We decided to expand the knowledge about these interesting crystal properties and prepared a series of cadmium(II) metal-organic compounds bearing 4-methylpyridine and three halide ions ( $X = \text{Cl}, \text{Br}, \text{I}$ ) as ligands, namely,  $[\text{CdCl}_2(4\text{-methylpyridine})_2]_n$  (**1**),  $[\text{CdBr}_2(4\text{-methylpyridine})_2]_n$  (**2**), and  $[\text{CdI}_2(4\text{-methylpyridine})_2]_n$  (**3**). The compounds were synthesised by layering the aqueous solution of a cadmium(II) halide ( $\text{CdX}_2$ ) with the ethanol solution of 4-methylpyridine. The crystal structures of **1–3** were determined using single-crystal X-ray diffraction (SCXRD). To explore the thermal stability and potential mechanical responses to temperature changes, hot-stage microscopy was employed. Mechanically induced responses for each compound were assessed by isolating needle-like single crystals and conducting bending experiments. A modified three-point bending method was utilized to calculate the bending strain ( $\epsilon$ ), revealing that compound **1** exhibits elasticity, compound **2** displays plasticity, and compound **3** demonstrates brittleness. The observed dynamic responses were thoroughly investigated from the structural point of view, therefore providing valuable information about the impact of the weak intermolecular interactions on flexible responses.

- [1] P. Commins et al., *Chem. Commun.* 52 (2016) 13941–13954.
- [2] S. Saha et al., *Acc. Chem. Res.* 11 (2018) 2957–2967.
- [3] B. B. Rath, J. J. Vittal, *CrystEngComm* 23 (2021) 5738–5752.
- [4] M. Đaković et al., *Angew. Chem. Int. Ed.* 57 (2018) 14801–14805.
- [5] M. Pisačić et al., *Chem. Mater.* 33 (2021) 3660–3668.
- [6] M. Pisačić et al., *CrystEngComm* 23 (2021) 7072–7080.
- [7] M. Pisačić et al., *Chem. Mater.* 34 (2022) 2439–2448.
- [8] A. Whorty et al., *Nat. Chem.* 10 (2018) 65–69.

This work has been fully supported by the Croatian Science Foundation under project “From form to function: Mechanically flexible crystalline materials with controllable responses“(IP-2019-04-1242).

## CHIRAL METAL-ORGANIC FRAMEWORKS OF COPPER(II): SYNTHESIS AND STABILITY IN SOLID STATE

**Marija Zora Mišković<sup>1</sup>, Zvonimira Lemaić<sup>1</sup>, Darko Vušak<sup>2</sup>, Biserka Prugovečki<sup>2</sup>**

<sup>1</sup>University of Zagreb Faculty of Science, Department of Biology, Ravnice 48, 10000 Zagreb, Croatia

<sup>2</sup>University of Zagreb Faculty of Science, Department of Chemistry, Horvatovac 102a, 10000 Zagreb, Croatia  
mmiskovic@stud.biol.pmf.hr, zlemaic@stud.biol.pmf.hr

Copper(II) coordination compounds with heterocyclic bases and amino acids are known for building various architectures, which makes them interesting systems for investigations in crystal engineering [1]. Given their diverse physical and chemical properties, they are considered for applications in host/guest chemistry and have potential applications in biomedicine, industry, materials science and environment protection [1,2]. The practical use of metal-organic frameworks (MOFs), ranging from adsorption/separation to controlled storage and release, depends on their stability in humid or aqueous environments. This aspect becomes particularly crucial when considering their potential commercial and industrial applications [3].

In this study, we were interested in the stability of MOFs with respect to humidity. Three novel chiral three-component MOFs consisting of copper(II) with 1,2-bis(4-pyridyl)ethene (bpe) and amino acids (L-serine, HSer; L-homoserine, HHser; and L-threonine, HThr) were synthesized using mechanochemical methods:  $\{[\text{Cu}(\mu\text{-Ser})(\mu\text{-bpe})]\text{NO}_3 \cdot \text{solvents}\}_n$  (MOF 1),  $\{[\text{Cu}(\mu\text{-Hser})(\mu\text{-bpe})]\text{NO}_3 \cdot \text{solvents}\}_n$  (MOF 2), and  $\{[\text{Cu}(\mu\text{-Thr})(\mu\text{-bpe})]\text{NO}_3 \cdot \text{solvents}\}_n$  (MOF 3). Subsequently, the MOFs' stability was assessed at various humidity levels, ranging from 0 to 100%. The samples were placed in hermetically sealed chambers for one week and subsequently analyzed using powder X-ray diffraction.

[1] D. Vušak et al., Cryst. Growth Des. 17 (2017) 6049-6061.

[2] T. R. Cook et al., Chem. Rev. 113 (2013) 734-777.

[3] H. Jasuja et al., Langmuir 49 (2012) 16874-16880.

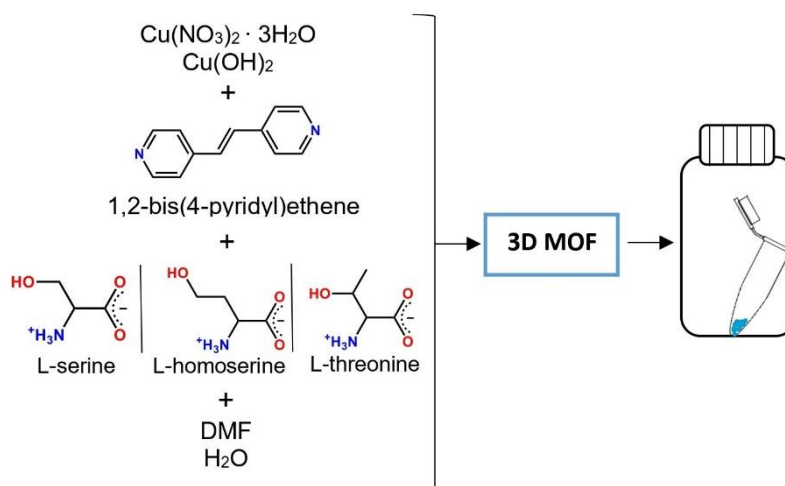

## MODIFICATIONS OF SILICATE FILLER WITH SILANES

**Iva Movre Šapić, Iva Krpeljević, Mirela Leskovac**

University of Zagreb Faculty of Chemical Engineering and Technology, Trg Marka Marulića 19, 10000 Zagreb, Croatia

imovre@fkit.unizg.hr

The aim of this work was to investigate the influence of organosilanes 3-aminopropylsilanetriol (APST), 3-aminopropyltriethoxysilane (APTS), 3-methacryloxypropyltrimethoxysilane (MPS), 3-glycidoxypropyltrimethoxysilane (GPTMS) and hexamethyldisilazane (HMDS) on silicate filler (AEROSIL® 200). These modified fillers were also compared with an industrially processed silicate filler, R 711.

By definition, fillers are particulate materials that are added to polymers to improve the physical properties and/or reduce the cost of the composite. The surface of natural fillers based on silicon dioxide, SiO<sub>2</sub>, is partially or completely hydrated and therefore hydrophilic. By depositing organic substances on the hydrophilic surface of natural and synthetic inorganic fillers, their dispersibility and functionality can be improved<sup>1</sup>. The basic method for converting hydrophilic inorganic fillers into ones with covalently bound organic groups on the surface is silane treatment<sup>2</sup>.

The samples were characterized by contact angle and surface energy measurements, differential scanning calorimetry (DSC) and thermogravimetric analysis (TGA), and attenuated total reflectance Fourier transform infrared spectroscopy (ATR-FTIR).

The results of the contact angle and surface energy measurements indicate that the hydrophobization of the surface has occurred, the biggest for the silica modified with MPS. DSC analysis determined the glass transition temperatures, which indicates the amorphous nature of the samples and that the addition of silanes has an influence on the thermal properties of the filler. TGA confirmed the functionalization of the silicate filler with silanes and determined the decrease in thermal stability of the composite.

ATR-FTIR spectra also confirmed the successful modification of the silica surface.

[1] M. Strle et al., Adv. Powder Technol. 4 (1993) 49-58.

[2] B. Indumathy et al., Polymers 15 (2023) 2517.

161

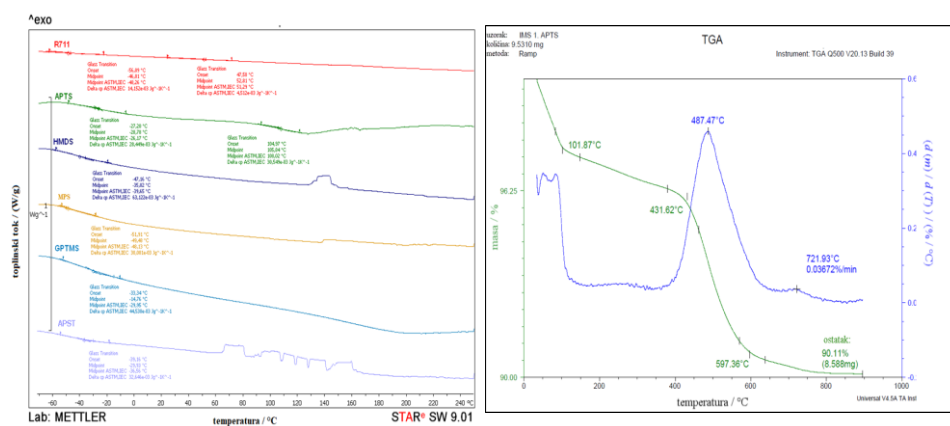

## CHARACTERIZATION OF CERAMIC MATERIALS INDUSTRIAL BY-PRODUCT BASED

**Sanja Nikolovski, Marija Kovač, Bojan Miljević, Vesna Miljić, Snežana Vučetić**

University of Novi Sad, Faculty of Technology, Laboratory for Materials in Cultural Heritage (HERITAGELAB),  
Bulevar cara Lazara 1, 21000 Novi Sad, Serbia  
nikolovskisanja9@gmail.com

Environmental pollution is one of the current world problems, which puts millions of people at risk, especially in regions of industrial ore processing zones, where, in addition to significant CO<sub>2</sub> emissions, large concentrations of harmful particles are emitted into the air and waste landfills are formed that occupy large areas. One of such industries is the industry of processing bauxite into alumina, where red mud is generated. This material is highly alkaline with the possible presence of heavy metals and radioactive elements. Depending on the quality of the ore being processed, 30-40% of the total ore mass is separated into red mud. Waste is stored in large pools, and in the case of mud spilling from the pool or exposure to the red mud, serious pollution and potential endangerment of the surrounding living world occurs. To reduce waste and pollution, the industry strives to develop products, such as bricks or cement, which include by-products that will reduce the cost of the process and the final product. The main goal of this work was design of ceramic materials based on red mud and characterization of their properties and quality. Valorization of the red mud, and qualitative and quantitative analysis of the developed ceramic materials samples was performed. Thermal, chemical, mineralogical, and morphological characteristics, particle size distribution, and effects on health and environment were studied. Obtained results show the possibility of using red mud in ceramic materials production, which can reduce environmental pollution in the future and contribute to the economy of the production process. Also, the possibility to obtain products that do not have harmful effects on the environment is determined, while certain product characteristics are improved compared to commercial products.

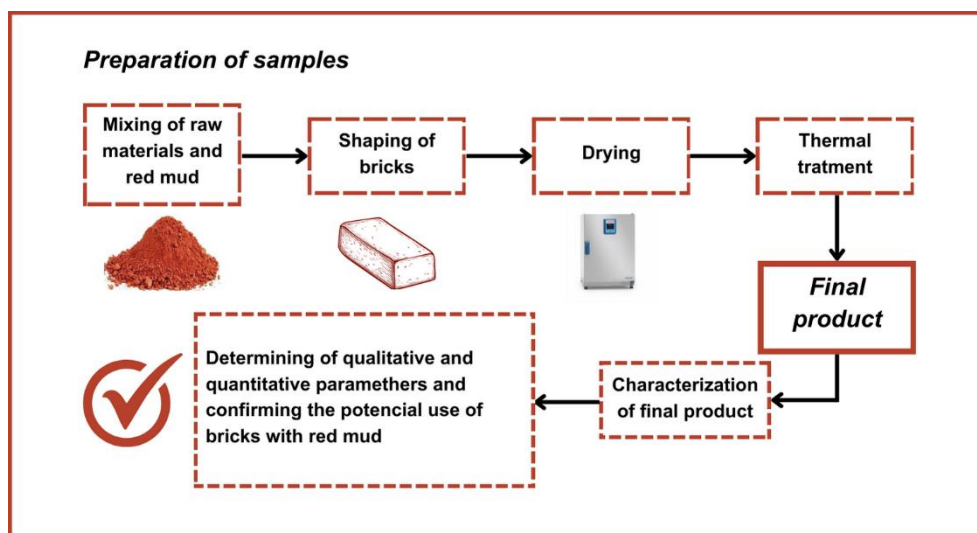

## SYNTHESIS AND CHARACTERIZATION OF A NOVEL XANTHAN GUM-GRAFT-POLY(METHYL METHACRYLATE) COPOLYMER

**Kristina Novaković, Rafael Anelić, Marija Bićanić, Luka Đuran, Fabio Faraguna**

University of Zagreb Faculty of Chemical Engineering and Technology, Trg Marka Marulića 19, 10000 Zagreb, Croatia  
knovakovi@fkit.unizg.hr

In this poster presentation, we present the synthesis and characterization of a novel graft copolymer of xanthan gum and methyl methacrylate. Xanthan gum is a natural polysaccharide which has many uses in the food and pharmaceutical industries as a thickening agent, as a stabiliser for APIs and even some niche uses in the oil extracting industry and agriculture [1, 2]. Methyl methacrylate is a monomer used for production of a widely used polymer poly(methyl methacrylate) as well as many copolymers [3, 4]. Experiments were carried out in a 100 mL jacketed reactor to deduce the optimal reaction conditions to achieve a satisfactory conversion and grafting efficiency. The characterisation of the graft copolymers was done primarily with Fourier-transform infrared spectroscopy (FTIR) and proton nuclear magnetic resonance spectroscopy (<sup>1</sup>H-NMR). Additional characterizations were carried out using differential scanning calorimetry (DSC) and thermogravimetric analysis (TGA) to determine thermal stability and thermal transitions.

- [1] S. Chaturvedi et al., *Microbial Polymers*, Springer, 2021.
- [2] M. H. Abu Elella et al., *J. Environ. Chem. Eng.* 9 (2021) 104702.
- [3] A. Bettencourt et al., *J. Microencapsul.* 29 (2012) 353-367.
- [4] P. E. Feuser et al., *Macromol. Symp.* 343 (2014) 65-69

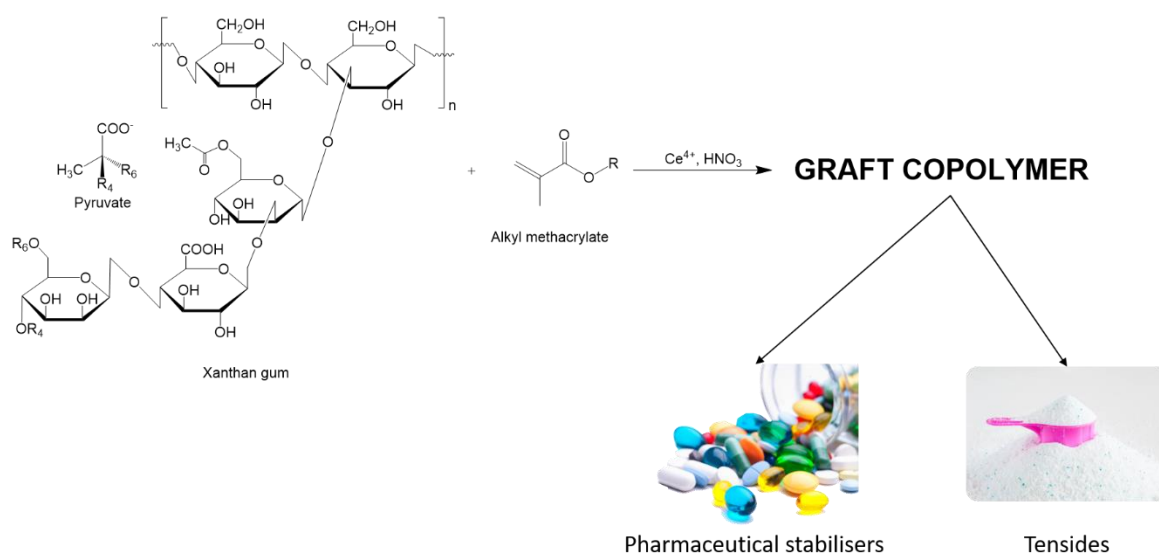

Figure 1. Synthesis of graft copolymer of xanthan gum and methyl methacrylate using cerium (IV) ammonium nitrate.



## MIKROVALNO POTPOMOĞNUTA SOL-GEL SINTEZA NANOČESTICA TITANIJEVA DIOKSIDA

### MICROWAVE ASSISTED SOL-GEL SYNTHESIS OF TITANIUM DIOXIDE NANOPARTICLES

**Josip Omrčen<sup>1</sup>, Ivana Gabelica<sup>1</sup>, Debora Briševac<sup>1</sup>, Davor Ljubas<sup>1</sup>, Arijeta Bafti<sup>2</sup>, Gordana Matijašić<sup>2</sup>, Lidija Ćurković<sup>1</sup>**

<sup>1</sup>Sveučilište u Zagrebu Fakultet strojarstva i brodogradnje, Ivana Lučića 5, 10000 Zagreb, Hrvatska

<sup>2</sup>Sveučilište u Zagrebu Fakultet kemijskog inženjerstva i tehnologije, Trg Marka Marulića 19, 10000 Zagreb, Hrvatska  
josip.omrcen6@gmail.com

Nanočestice titanijevog dioksida ( $\text{TiO}_2$ ) mogu se sintetizirati raznim fizikalnim metodama kao što su koprecipitacija, hidrotermalna, solvotermalna i onedavno mikrovalno potpomognuta sinteza. U usporedbi s ostalim gore navedenim metodama, mikrovalna sinteza temelji se na interakciji mikrovalova s materijalom na molekulskoj razini, točnije molekulski dipoli apsorbiraju mikrovalove i njihovu energiju pretvaraju u toplinu, što rezultira generiranjem topline unutar samog materijala ili suspenzije. Temperaturni gradijent je kod mikrovalne sinteze stoga suprotan onom kod konvencionalnog zagrijavanja, tj. iznutra prema van, već se radi o tzv. zagrijavanju u srži (*engl. in-core*). U ovom radu pripravljene su nanočestice titanijevoga dioksida ( $\text{TiO}_2$ ) primjenom mikrovalno potpomognute sol-gel sinteze. Za pripremu sola (koloidne otopine) titanijevog dioksida korišten je titanijev izopropoksid kao prekursor, 2-propanol kao otapalo, acetilaceton za kompleksiranje te nitratna kiselina kao katalizator. Iz pripravljene koloidne otopine sintetizirana su tri uzorka titanijevog dioksida u mikrovalnom reaktoru na temperaturi 150 °C tijekom 30 minuta i na temperaturi 200 °C tijekom 20 i 30 minuta.

Fazni sastav pripremljenih uzoraka određen je rendgenskom difrakcijskom analizom (XRD) i infracrvenom spektroskopijom s Fourierovom transformacijom (FTIR). Izoterme adsorpcije/desorpcije dušika korištene su za određivanje Brunauer, Emmett i Teller (BET) specifične površine i raspodjele veličina pora. Vrijednosti energije energetskog procjepa uzoraka  $\text{TiO}_2$  određen je spektroskopijom difuzne refleksije (DRS).

XRD metodom je utvrđeno da je u uzorku  $\text{TiO}_2$  sintetiziranom na temperaturi 150 °C tijekom 30 minuta prisutna amorfna faza, dok je u ostalim uzorcima koji su sintetizirani na temperaturi 200 °C prisutna kristalna faza anatas. BET metodom je utvrđeno da je za uzorak  $\text{TiO}_2$  sintetiziran na temperaturi 200 °C tijekom 20 minuta specifična površina najveća odnosno 181,1 m<sup>2</sup>g<sup>-1</sup>. Srednji promjer pora tog uzorka je 5,4 nm što odgovara mezoporoznoj strukturi.

Ovaj rad izrađen je uz financijsku potporu Hrvatske zaklade za znanost projektom HRZZ-IP-2022-10-4400 pod nazivom Razvoj polimera s otiskom molekula za primjenu u analizi farmaceutika i tijekom naprednih postupaka obrade voda (MIPdePharma).

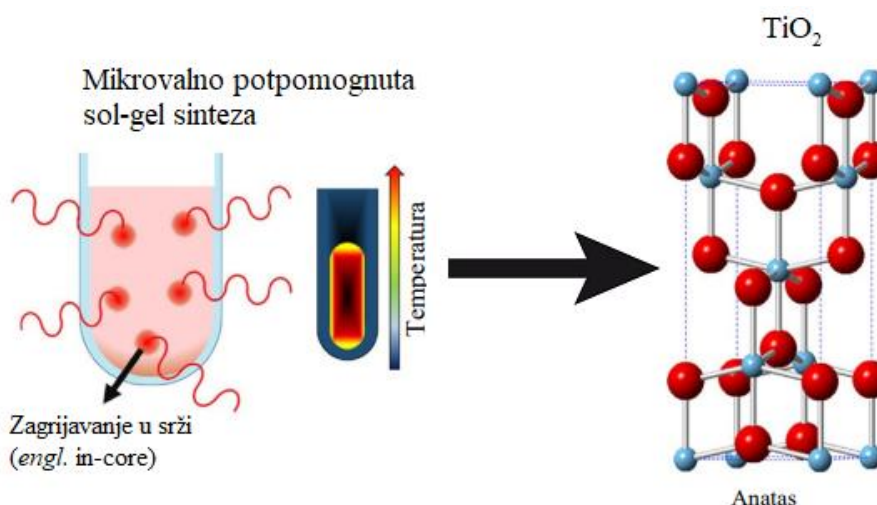

## PRIPRAVA I KARAKTERIZACIJA UGLJIKOVOG NITRIDA GRAFITNE STRUKTURE

### PREPARATION AND CHARACTERIZATION OF GRAPHITIC CARBON NITRIDE

**Ivan Petrinšak<sup>1</sup>, Debora Briševac<sup>1</sup>, Ivana Gabelica<sup>1</sup>, Davor Ljubas<sup>1</sup>, Arijeta Bafti<sup>2</sup>, Gordana Matijašić<sup>2</sup>, Lidija Ćurković<sup>1</sup>**

<sup>1</sup>Sveučilište u Zagrebu Fakultet strojarstva i brodogradnje, Ivana Lučića 5, 10000 Zagreb, Hrvatska

<sup>2</sup>Sveučilište u Zagrebu Fakultet kemijskog inženjerstva i tehnologije, Trg Marka Marulića 19, 10000 Zagreb, Hrvatska  
petrinsakivan@gmail.com

U ovom radu pripremljeni su uzorci ugljikovog nitrida grafitne strukture ( $g\text{-C}_3\text{N}_4$ ) toplinskom polimerizacijom dva prekursora. Za sintezu šest uzoraka  $g\text{-C}_3\text{N}_4$  korišteni su prekursori urea i melamin. Tri uzorka  $g\text{-C}_3\text{N}_4$  sintetizirana su u električnoj peći iz uree toplinskom obradom pri 450, 500 i 550 °C te još tri uzorka  $g\text{-C}_3\text{N}_4$  sintetizirana su iz melamina na isti način.

Za karakterizaciju sintetiziranih uzoraka korištena je rendgenska difrakcijska analiza (XRD), spektroskopija difuzne refleksije (DRS), infracrvena spektroskopija s Fourierovom transformacijom (FTIR) te Brunauer, Emmett i Teller (BET) analiza specifične površine.

Cilj rada bio je ispitati može li se iz navedenih prekursora, pri navedenim temperaturama, toplinskom polimerizacijom sintetizirati  $g\text{-C}_3\text{N}_4$  te koji režim toplinske polimerizacije je najpogodniji.

Nakon provedene XRD analize uzoraka  $g\text{-C}_3\text{N}_4$  sintetiziranih iz uree može se zaključiti da je u svim uzorcima prisutna faza  $g\text{-C}_3\text{N}_4$ . Difraktogrami dobiveni XRD analizom uzoraka  $g\text{-C}_3\text{N}_4$  sintetiziranih iz melamina ukazuju na prisutnost melem faze, koja je ujedno i jedina prisutna faza u uzorku sintetiziranom pri 450 °C, a povećanjem temperature stvara se  $g\text{-C}_3\text{N}_4$  faza. Na difraktogramu  $g\text{-C}_3\text{N}_4$  sintetiziranog pri 500 °C može se vidjeti nekoliko manjih pikova koji pripadaju melamin fazi i karakteristični pik  $g\text{-C}_3\text{N}_4$  faze, iz čega se može zaključiti da se sav melamin nije prekrystalizirao u  $g\text{-C}_3\text{N}_4$ , što ukazuje da je najpogodnija temperatura obrade melamina 550 °C.

Na temelju provedenog istraživanja može se zaključiti da je najpogodnija temperatura obrade oba prekursora 550 °C. Što se tiče odabira prekursora, prema rezultatima BET analize urea je pogodnija, dok je prema rezultatima DRS analize i iskoristivosti mase uzoraka pogodniji melamin.

Ovaj rad izrađen je uz financijsku potporu Hrvatske zaklade za znanost projektom HRZZ-IP-2022-10-4400 pod nazivom Razvoj polimera s otiskom molekula za primjenu u analizi farmaceutika i tijekom naprednih postupaka obrade voda (MIPdePharma).

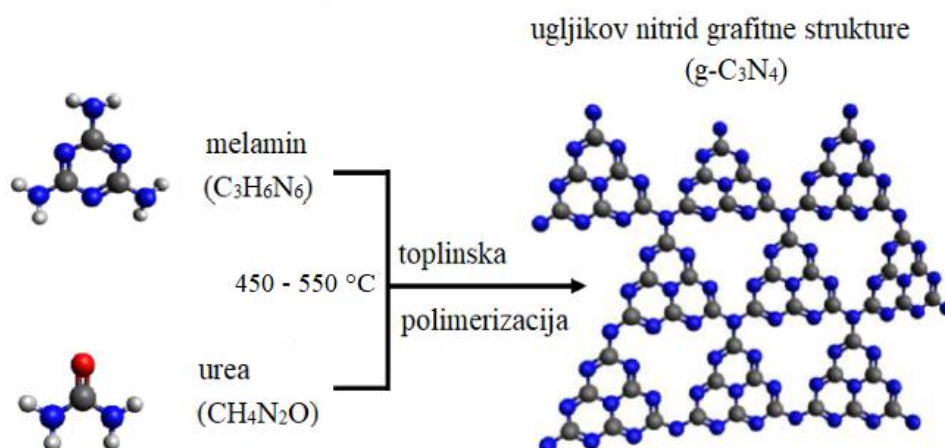

## HALKOGENI ATOMI U ULOZI AKCEPTORA HALOGENSKE VEZE U METALOORGANSKIM KOKRISTALIMA

### CHALCOGEN ATOMS AS HALOGEN BOND ACCEPTORS IN METALO-ORGANIC COCRYSTALS

**Lidija Posavec, Leo Pehar, Dominik Cinčić**

Sveučilište u Zagrebu Prirodoslovno-matematički fakultet, Kemijski odsjek, Horvatovac 102a, 10000 Zagreb, Hrvatska  
lposavec@chem.pmf.hr

Dizajn većine metaloorganskih kokristala u kojima su molekule povezane halogenskim vezama temelji se na strategijama koje uključuju neutralne koordinacijske spojeve kao akceptore halogenske veze i neutralne organske molekule kao donore. Akceptorska mjesta se na koordinacijske spojeve mogu uvoditi koordinacijom liganada poput halogenida ili pseudohalogenida ili dodatkom akceptorskih funkcionalnih skupina na periferiju većih organskih liganada [1]. Cilj ovog istraživanja bio je ispitati akceptorski potencijal izocijanatnih i izotiocijanatnih liganada, odnosno usporediti akceptorski potencijal atoma kisika i sumpora na periferiji navedenih liganada. U tu svrhu sintetizirani su izostrukturalni metalni kompleksi nikla (II) –  $\text{Ni}(\text{C}_5\text{H}_5\text{N})_4(\text{NCS})_2$  (**1**) i  $\text{Ni}(\text{C}_5\text{H}_5\text{N})_4(\text{NCO})_2$  (**2**) koji su kokristalizirani s perhalogeniranim donorima halogenske veze: 1,2-dijodtetrafluorbenzenom (**12tfib**), 1,3-dijodtetrafluorbenzenom (**13tfib**), 1,4-dijodtetrafluorbenzenom (**14tfib**), 1,3,5-trijod-2,4,6-trifluorbenzenom (**135tfib**) i jodpentafluorbenzenom (**ipfb**). Pretraživanje mogućnosti kokristalizacije provedeno je mehanokemijskom sintezom i kristalizacijom iz otopine, uz karakterizaciju nastalih produkata difrakcijom rentgenskog zračenja na polikristalnom uzorku i difrakcijom na jediničnom kristalu. Kao rezultat istraživanja sintetizirano je 10 novih metaloorganskih kokristala. U kokristalima spoja **1** dominantne međumolekulske interakcije su halogenske veze  $\text{I}\cdots\text{S}$ , dok su u kokristalima spoja **2** dominantne halogenske veze  $\text{I}\cdots\text{O}$  te vodikove veze  $\text{C-H}\cdots\text{O}$ . Rad opisuje po prvi put izolirane i strukturno karakterizirane kokristale koji sadrže metaloorgansku građevnu jedinicu s izocijanatnom skupinom kao akceptorom halogenske veze te je pokazano je da se izocijanatni kisik može iskoristiti kao pouzdan akceptor halogenske veze. Kroz ovih deset primjera strukturna analiza pokazala je da atom kisika može biti akceptor maksimalno dvije halogenske veze s dva susjedna donora, dok atom sumpora halogenskim vezama može biti povezan i do s tri donora. Takav trend se može pripisati steričkim utjecajima te većem atomskom radijusu sumpora što omogućava pristup većem broju donorskih molekula.

[1] V. Nemeč et al., *CrystEngComm* 23 (2021) 3063–3083.

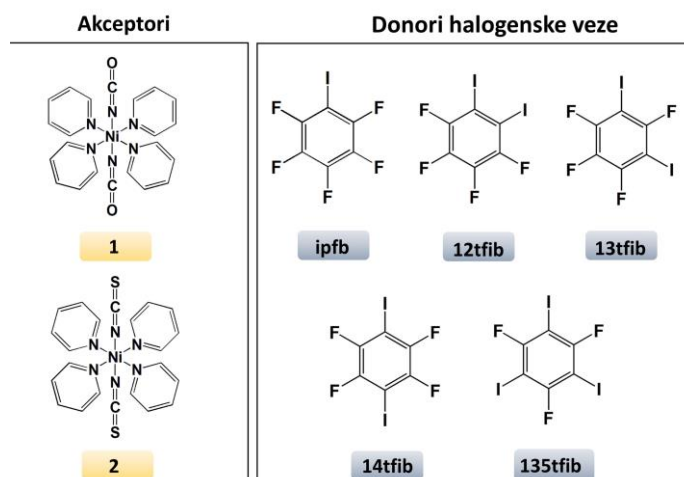

## MECHANOCHEMICAL SYNTHESIS AND SOLVATOMORPHISM OF TERNARY COPPER(II) COORDINATION COMPOUNDS WITH L-SERINE AND 2,2'-BIPYRIDINE

**Matea Primožić, Darko Vušak, Biserka Prugovečki**

University of Zagreb Faculty of Science, Department of Chemistry, Horvatovac 102a, 10000 Zagreb, Croatia  
mprimozic.chem@pmf.hr

Copper(II) coordination compounds with amino acids and heterocyclic bases have been studied mostly due to their antitumor activity [1]. Changing the type of ligands, i.e. amino acids and heterocyclic bases, leads to formation of different architectures, which are based on formation of hydrogen bonds and  $\pi$ -interactions [2]. Such coordination compounds containing hydrogen bond donors and/or acceptors can form porous structures where solvent molecules form 1D chains, or 2D/3D frameworks [3]. Porous compounds also have the ability to recognize and adsorb solvent/other guest molecules, which gives them potential application as catalysts or in solvent storage [4,5]. In CSD database, there are 57 data sets of compounds containing copper(II), aminoacidates and 2,2'-bipyridine, none of which contain L-serinate [6].

While studying the conditions of mechanochemical synthesis, two coordination compounds of copper(II) with 2,2'-bipyridine (bipy) and L-serine (L-HSer) were obtained:  $[\text{Cu}(\text{L-Ser})(\text{H}_2\text{O})(\text{bipy})]_2\text{SO}_4 \cdot 6\text{H}_2\text{O}$  ( $1\text{a} \cdot 6\text{H}_2\text{O}$ ) and  $[\text{Cu}(\text{L-Ser})(\text{H}_2\text{O})(\text{bipy})]_2\text{SO}_4$  ( $1\text{a}-\alpha$ ). Different hydrates of copper(II) sulphate and volume ratios of water/methanol were used in the reaction mixtures. Both compounds have already been characterized by single-crystal X-ray diffraction, including  $1\text{a}-\beta$  polymorph [4]. In order to investigate the stability of said compounds, they have been exposed to different conditions of relative humidity, and the atmosphere of methanol (at 20 °C). Compound  $1\text{a} \cdot 6\text{H}_2\text{O}$  has been successfully transformed into  $1\text{a}-\alpha$ , and vice versa, while in the atmosphere of methanol, both compounds partially transitioned to  $1\text{a}-\beta$ .

- [1] L. Ruiz-Azuara et al., *Curr. Med. Chem.* 17 (2010) 3606–3615.  
 [2] T. Sugimori et al., *Inorg. Chem.* 36 (1997) 576–583.  
 [3] D. Vušak et al., *Cryst. Growth Des.* 17 (2017) 6049–6061.  
 [4] D. Vušak, Doctoral Thesis, Faculty of Science, University of Zagreb, 2020.  
 [5] A. C. Kathalikkattil et al., *Polyhedron* 29 (2010) 1801–1809.  
 [6] C. R. Groom et al., *Acta Cryst. B* 72 (2016) 167–168.

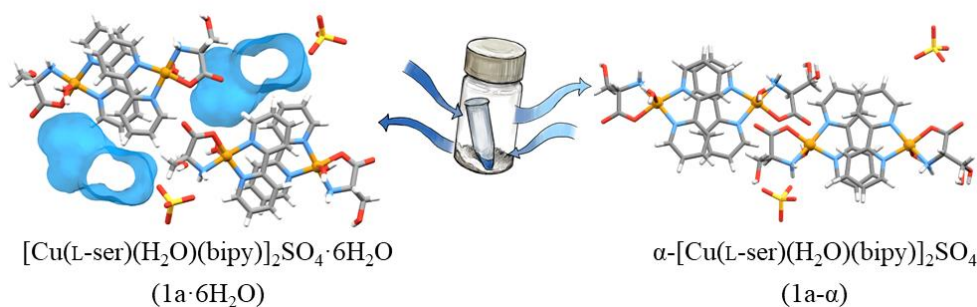

## UV-VIS ANALYSIS OF THE PROPOLIS WATER EXTRACT IN ANTIMICROBIAL COATING BEFORE ITS APPLICATION ON TEXTILE

**Iva Rezić, Darinka Cvetković, Maja Somogyi Škoc**

University of Zagreb Faculty of Textile Technology, Prilaz baruna Filipovića 28, 10000 Zagreb, Croatia  
iva.rezic@ttf.unizg.hr

Propolis is a natural, resinous, aromatic substance collected by honey bees. Bees use propolis as a material to coat and line their hives, sealing cracks to protect against various intruders and even mummifying different insects. This process ensures high sterility and cleanliness within the beehive. Various scientific studies have demonstrated the positive effects of propolis against bacteria, viruses, fungi, inflammations, as well as its proven antioxidative, anesthetic, antiparasitic, antitumor effects, along with strengthening the weakened immune system and promoting tissue regeneration. The chemical composition of propolis depends on the origin of the resins collected by bees, and it's known that bees collect propolis material from as many as 67 plant species.

In this research, antimicrobial substances in the water extract of the propolis sample will be examined using UV-VIS spectrometric methods before applying propolis to the textile surfaces using the sol-gel method. During the treatment of textile surfaces, it's necessary to monitor all substances before, during, and after the antimicrobial surface treatment, ensuring product quality and its final performance characteristics. UV-VIS spectrophotometry was chosen as an appropriate method for qualitative and quantitative chemical analysis in the textile industry process control, due to its simplicity and speed.

This work has been fully supported by Croatian Science Foundation under the project ABBAMEDICA IP-2019-04-1381.

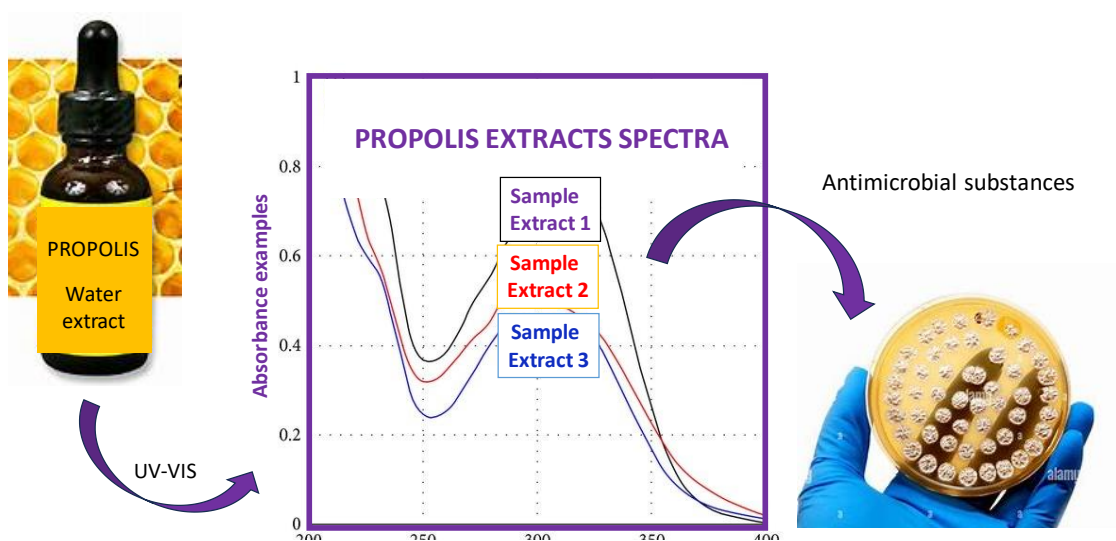

## THE DEGREE OF CHITOSAN DEACETYLATION: POTENTIAL OF EXPERIMENTAL EQUATION APPLICATION

**Nadežda Seratlić<sup>1</sup>, Nevena Hromiš<sup>1</sup>, Senka Popović<sup>2</sup>, Danijela Šuput<sup>1</sup>, Jovana Pantić<sup>2</sup>, Ivana Čabarkapa<sup>2</sup>**

<sup>1</sup>University of Novi Sad, Faculty of Technology, Bulevar cara Lazara 1, 21000 Novi Sad, Serbia

<sup>2</sup>University of Novi Sad, Institute of Food Technology, Bulevar cara Lazara 1, 21000 Novi Sad, Serbia  
seratlic.nadezda@uns.ac.rs

Extensive research in recent years has focused on exploring the broad industrial potential of chitosan. The degree of deacetylation (DD) stands as a pivotal chemical attribute, significantly influencing the physical and biological properties crucial for its various applications.

Numerous methods have been developed to determine the degree of deacetylation: linear potentiometric titration, infrared spectrophotometry, nuclear magnetic resonance spectroscopy, pyrolysis-mass spectrometry, UV spectrophotometry, titrimetry. The challenge for researchers lies in selecting an appropriate method due to factors like time consumption, costliness (notably nuclear magnetic resonance spectroscopy), and potential sample destruction inherent in certain methods. Among these, infrared spectroscopy has emerged as a preferred method due to its rapidness and non-destructiveness.

This study delved into the utilization of experimental equations, as documented in literature, to determine the degree of chitosan deacetylation under laboratory conditions using three chitosan samples differing in viscosity, each with a documented degree of deacetylation between 75 and 85%. Using three distinct methods—potentiometric titration, acid-base titration, and infrared spectrophotometry—was aimed at calculating chitosan's deacetylation degree.

While acid-base and potentiometric titration showcase simplicity in required equipment, the latter proves time-intensive. In contrast, infrared spectrophotometry demands more intricate instrumentation but requires only minimal samples, ensuring rapid analysis.

The results showed that the methods of infrared spectrophotometry and acid-base titration, with the application of reported experimental equations, can be used to assess the degree of chitosan deacetylation. However, potentiometric titration did not validate its efficacy for this intended purpose.

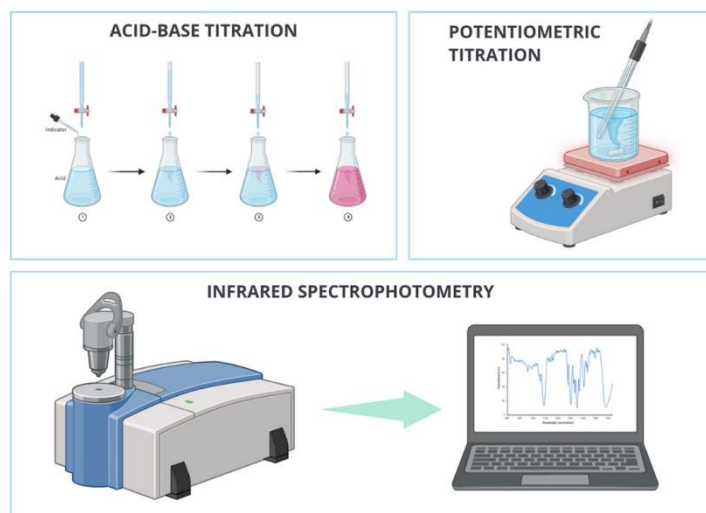

## TREATMENTS WITH PROPOLIS ON NONWOVEN FOR DISPOSABLE NURSING PADS

**Maja Somogyi Škoc, Darinka Cvetković, Iva Rezić**

University of Zagreb Faculty of Textile Technology, Prilaz baruna Filipovića 28, 10000 Zagreb, Croatia  
cvetkovicdarinka@gmail.com

The breast or mammary gland (Latin mamma, Greek mastos) is the largest skin gland and consists of 20 to 25 individual mammary glands. A milk duct leads from each mammary gland to the nipple. Due to the effect of maternal hormones during pregnancy and breastfeeding, milk is produced and secreted, which travels from the mammary glands through the ducts to the nipple. In breastfeeding women, mastitis occurs when bacteria (from the baby's mouth or skin) enter the milk duct through a crack in the nipple, i.e. when the milk is not fully expressed, resulting in a blockage of the milk duct. Compresses can help to relieve the pain in the event of inflammation. Breast compresses in the form of nursing pads with natural substances cannot replace medication (antibiotics), but they can help to eliminate the symptoms more quickly. In line with these considerations, this work focussed on a natural solution - a bee product. Propolis is a bee product that has been known for centuries for its biological and pharmacological properties. It has always been used in traditional medicine and also in modern medicine for its antibacterial, antiseptic and anti-inflammatory properties. The chemical substances contained in propolis include waxes, resins, balsams, aromatic and essential oils, pollen and other organic substances. Many studies have shown the high sensitivity of a large number of bacterial species to propolis extracts. It is assumed that the antibacterial effect of propolis is due to the flavonoids, aromatic acids and esters contained in the propolis resin. As a powerful antioxidant, it is effective against free radicals, which are now considered to be the cause of many diseases, including serious ones.

In this work, the initial parameters of propolis and paraffin as basic components of the treatments were varied. Samples of non-woven textiles used for medical products were treated by dip-coating. In this first phase the surface properties of the samples, the absorption time of the drops, the determination of the pH of the aqueous extract and the determination of the recovery angle were determined. The results obtained served as a guideline for the selection of samples that fulfil the condition of a pleasant feel of the textiles, as one of the basic requirements for a possible commercial use and an antimicrobial test.

170

This work has been fully supported by Croatian Science Foundation under the project ABBAMEDICA IP-2019-04-1381.

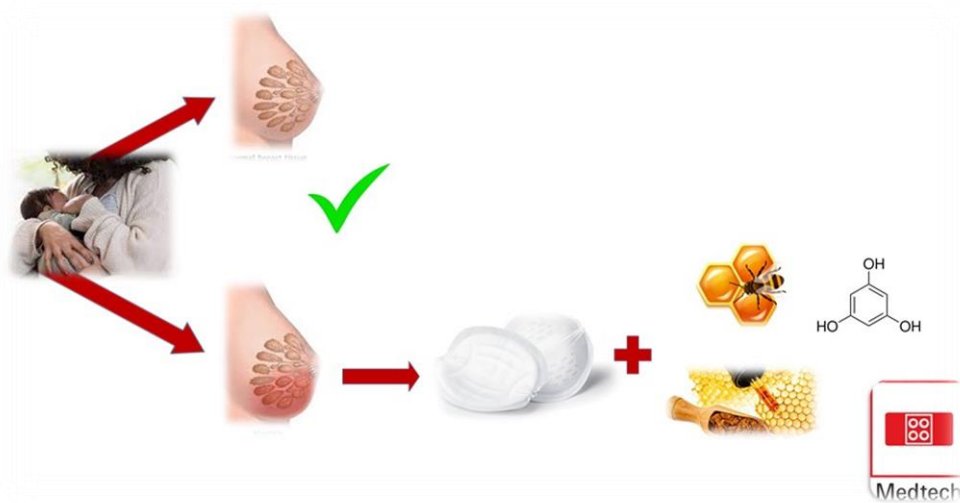

# POSTUPCI RECIKLIRANJA PEROVSKITNIH FOTONAPONSKIH ĆELIJA

## PROCEDURES FOR RECYCLING PEROVSKITE PHOTOVOLTAIC CELLS

**Josipa Spudić**

Sveučilište u Zagrebu Fakultet kemijskog inženjerstva i tehnologije, Trg Marka Marulića 19, 10000 Zagreb, Hrvatska  
jspudic@fkit.unizg.hr

Perovskitne fotonaponske ćelije izazvale su interes zbog visoke učinkovitosti pretvorbe sunčeve energije u električnu. Princip kružnog gospodarstva zahtijeva definiranje postupaka zbrinjavanja i recikliranja proizvoda i prije njihove upotrebe, te će se u ovom radu opisati pojedini postupci recikliranja perovskitnih ćelija kako bi se uspješno približile tržištu. Postupci su opisani na različitim konfiguracijama perovskitnih fotonaponskih ćelija te su međusobno uspoređeni. Prikazano je kako se perovskitni sloj može ukloniti i reciklirati na nekoliko načina i iskoristiti za sintezu novih ćelija te time spriječiti ispuštanje toksičnog olova u okoliš [1]. Prisutne skupe materijale kao što su staklena podloga s nanesenim slojem metalnog oksida ili sloj za transport šupljina moguće je ponovno upotrijebiti, dok se elektroda od zlata ili srebra može prikupljati na dva načina: iz otopine ili ljepljivom trakom [2]. Razmotreni postupci recikliranja se temelje na upotrebi različitih otapala koja su kancerogena ili toksična te utječu na zdravlje živih organizama i na okoliš, stoga njihovo korištenje zahtijeva moguće recikliranje ili pravilno zbrinjavanje za razvoj industrijskih postupaka recikliranja.

- [1] F. W. Liu et al., Mater. Today 43 (2021) 185-197.  
[2] F. Yang et al., J. Mater. Chem. A 9 (2021) 2612-2627.

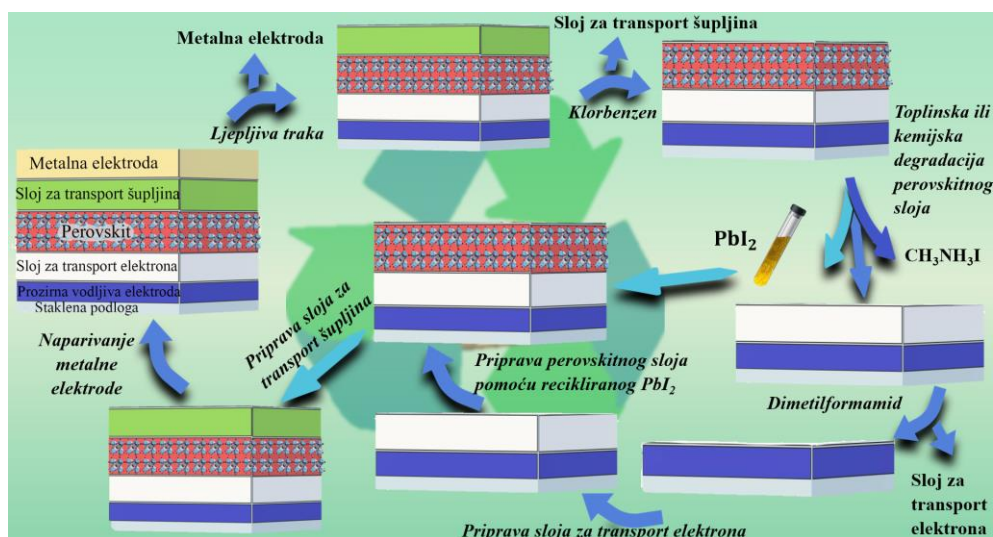



## PROBING MECHANICALLY AND THERMALLY STIMULATED FLEXIBLE RESPONSE OF CRYSTALLINE CADMIUM(II) COORDINATION COMPOUNDS

**Luka Sumić, Mateja Pisačić, Marijana Đaković**

University of Zagreb Faculty of Science, Department of Chemistry, Horvatovac 102a, 10000 Zagreb, Croatia  
lsumic.chem@pmf.hr

Crystalline materials have been perceived throughout history as brittle and rigid to mechanically induced stress. However, relatively recently it has been noted that there is a vast range of crystals showing elastic and plastic bendability in response to mechanical force. [1–3] First reported elastic crystals were of organic composition that encouraged further research and led to discovery of flexible metal-organic systems which in turn displayed improved conductive, magnetic, and thermal properties. The potential future use of these bendable crystals in emerging technologies is shown in the increasing number of recently published articles and research done on the topic. It has been reported that 1D coordination polymers of cadmium(II) with halide and heterocyclic ligands show a notable range of different flexible responses [4–7].

In this research we decided to examine mechanical and thermal properties of 1D coordination polymers of cadmium(II) equipped with halide and 3-methylpyridine ligands. Three compounds were prepared, namely  $[\text{CdCl}_2(3\text{-methylpyridine})_2]_n$  (**1**),  $[\text{CdBr}_2(3\text{-methylpyridine})_2]_n$  (**2**) and  $[\text{CdI}_2(3\text{-methylpyridine})_2]_n$  (**3**). Crystallization was performed using the layering technique from ethanol solution of 3-methylpyridine and aqueous solution of cadmium(II) halides giving needle-like crystals of good quality and reproducibility. Each of the compounds was characterized using powder X-ray diffraction (PXRD) and their crystal structures were determined by single-crystal X-ray diffraction (SCXRD). The examination of the mechanical responses was done using a modified three-point bending method resulting in compound **1** and **2** being elastic, while **3** was excluded from examination due to unsuitable morphology for testing mechanical behaviour. For crystals displaying elastic responses (**1** and **2**), the response was quantified by calculating bending strain. Compounds **1** and **2** showed thermal stability when subjected to hot stage microscopy, whereas compound **3** showed low thermal stability and melted at relatively low temperatures. Observed mechanical properties of crystals **1–3** were correlated with structural features what provided a deeper insight into the origin of the flexible responses.

172

---

- [1] P. Naumov et al., *Chem. Rev.* 115 (2015) 12440–12490.
- [2] P. Commins et al., *Chem. Commun.* 52 (2016) 13941–13954.
- [3] S. Saha et al., *Acc. Chem. Res.* 11 (2018) 2957–2967.
- [4] M. Đaković et al., *Angew. Chem. Int. Ed.* 57 (2018) 14801–14805.
- [5] M. Pisačić et al., *Chem. Mater.* 33 (2021) 3660–3668.
- [6] M. Pisačić et al., *CrystEngComm* 23 (2021) 7072–7080.
- [7] M. Pisačić et al., *Chem. Mater.* 34 (2022) 2439–2448.
- [8] O. Mišura et al., *Cryst. Growth Des.* 23 (2023) 1318–1322.

This work has been fully supported by the Croatian Science Foundation under project “From form to function: Mechanically flexible crystalline materials with controllable responses“ (IP-2019-04-1242).

## TOPLINSKA SVOJSTVA MJEŠAVINA PCL S TPS-OM RAZLIČITOG PODRIJETLA

### THERMAL PROPERTIES OF BLENDS OF PCL WITH TPS OF DIFFERENT ORIGINS

**Tomislav Šalinović<sup>1</sup>, Andrija Jarak<sup>1</sup>, Miroslav Šlouf<sup>2</sup>, Elvira Vidović<sup>1</sup>**

<sup>1</sup>Sveučilište u Zagrebu Fakultet kemijskog inženjerstva i tehnologije, Trg Marka Marulića 19, 10000 Zagreb, Hrvatska

<sup>2</sup>Institute of Macromolecular Chemistry, Czech Academy of Sciences, Heyrovského nam. 2, 162 06 Prague, Czechia  
tsalinovi@fkit.unizg.hr

Polimerni materijali koriste se u mnogim područjima ljudske aktivnosti, različitim industrijama, kao ambalažni materijal pa čak i u medicini. Međutim, zbog otpornosti sintetskih polimernih materijala na razgradnju oni štetno utječu na okoliš i čovjekovo zdravlje. Jedno od potencijalnih rješenja koje bi umanjilo ili čak eliminiralo njihovu štetnost čini se priprema mješavina konvencionalnih i bipolimera, čija primjena se široko razmatra. Zbog toga se danas potiče sve veća uporaba biorazgradivih polimera, a jedan od najpoznatijih među njima je biljni polisaharid škrob. Međutim, prethodno se mora provesti njegova plastifikacija. U ovom radu je ona provedena koristeći glicerol kao plastifikator kako bi se narušila kristalna struktura i dobili potpuno amorfni krumpirov (A), odnosno bobov (T) termoplastični škrob (TPS).

Ovdje su priređene mješavine polikaprolaktona (PCL), biorazgradivog sintetskog kristalastog polimera i TPS-a u Brabender mješalici u omjerima 30/70, 50/50 i 70/30 mas. % / mas. %. Naknado su priređene mješavine pomoću preše oblikovane u pločice dimenzija 10x10 cm<sup>2</sup>. Za usporedbu isprešane su i pločice čistih uzoraka: PCL, bobov TPS (T) i krumpirov TPS (A). Ispitana su toplinska postojanost i ponašanje priređenih homopolimera i njihovih mješavina pomoću DSC i TGA analiza. Toplinska razgradnja uzoraka TPS gotovo se preklapa osim što bobov TPS pokazuje početni gubitak mase pri znatno nižoj temperaturi (160 °C) u usporedbi s krumpirovim TPS (185 °C), dok PCL pokazuje početak toplinske razgradnje tek pri ca. dvostruko višoj temperaturi (350 °C). U skladu s time, s porastom udjela TPS-a značajno se smanjuje toplinska postojanost mješavina.

DSC analizom određivale su se temperature staklišta ( $T_g$ ), taljenja i kristalizacije, te entalpije taljenja i kristalizacije iz kojih je izračunat sadržaj kristalne faze. TPS boba ima  $T_g$  pri -75,6 °C, krumpirov TPS pri -71,6 °C, dok je kod PCL staklište pri -73,5 °C. Od homopolimera jedino PCL sadrži kristalnu fazu (1,93 %). Dodatak TPS-a doprinosi povećanju kristalne faze pri čemu je utjecaj izraženiji u slučaju dodanih manjih količina, 30 % i 50 mas. %, a zanemariv je ili čak negativan u slučaju dodatka 70 mas. % TPS-a.

## GOLD SPONSOR



## SILVER SPONSORS



## BRONZE SPONSORS



# SPONSOR OF AWARD FOR THE BEST SECTIONAL LECTURE



*chemengineering*

an Open Access Journal by MDPI

## SPONSORS



## DONORS



# UNDER THE AUSPICES



Ministarstvo znanosti i obrazovanja



Sveučilište u  
Zagrebu



**HIS**

HRVATSKI INŽENJERSKI SAVEZ  
CROATIAN ENGINEERING ASSOCIATION

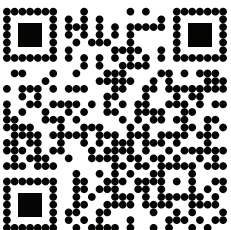

BOOK OF ABSTRACTS |  
KNJIGA SAŽETAKA

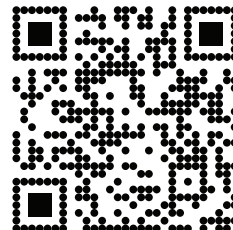

CONFERENCE PROGRAM |  
PROGRAM SKUPA

# JGL Establishes Scientific Advisory Board to Advance the Development of Innovative and Complex Products

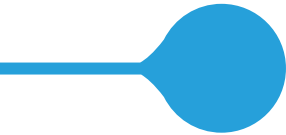

*This is a big step forward for us, and for Croatia as a whole, because we are developing science-based, advanced products tailored to the needs of patients and consumers, says JGL*

The JGL Scientific Advisory Board was established in September 2021 with the aim of positioning JGL as an innovator in the development of advanced, differentiated products in three strategic therapeutic areas – flu and cold, ophthalmology and dermatology. This independent body comprises top domestic and foreign experts and raises the science profile of the company's R&D projects. The company now operates in 60 markets around the world, either directly or through partners, and its portfolio consists of 150 brands, 300 products and 650 variations tailored to the needs of specific markets.

- The establishment of the Scientific Advisory Board is another step forward in the development of innovative products around which we build our science and innovation ecosystem. The goal of this body is to cooperate with the JGL team and steer existing and develop new ideas for the company's manufacturing and technology portfolio, all of it based on sound science, says Mislav Vučić, CEO of JGL. He also adds that he is very proud of the combination of cutting-edge science and talent, especially during their annual in-person meetings, where they network and share relevant, science-based knowledge and ideas through synergy and lay the groundwork for increasing the company's competitiveness.

Third SAB meeting was organized in September 2023. The Advisory Board consists of nine experts, internationally recognised in their respective fields,

same being of high relevance for JGL projects. They include Prof. Henning H. Blume, PhD, Prof. Ralph Mösges, PhD, Prof. Stipan Jonjić, PhD, Jag Ahluwalia, PhD, Prof. Özgen Özer, PhD, Prof. Vladimir Trkulja, PhD, Chief Physician Sonja Jandroković, PhD, Andreas Bilstein, PhD, and Prof. Jasmina Lovrić, PhD. The team is coordinated by Zdravka Knežević, PhD, Director of Scientific Operations at JGL, who participated in a number of similar initiatives and projects and has over 30 years of experience in R&D, drug registration, and clinical development.

- I am delighted that I get to share my knowledge and experience from international companies at JGL, as well as cooperate with a great team of experts from the EU, UK, Turkey and other global markets on the Board. I believe that this represents great progress for JGL and our teams, as well as for Croatia as a whole, because we will be able to develop new products for the benefit of our patients and the treatment needs of modern society, with clear scientific rationale, emphasises Knežević.

In cooperation with SAB Memebres, relevant JGL teams conducted a series of innovative formulation, preclinical, clinical, and analytical studies in 2022 and 2023, all with the aim of creating a network of relevant knowledge and identifying new projects for the company's therapeutic areas and technology portfolio.





The JGL Scientific Advisory Board with JGL team

### A Major European Manufacturer of Sterile Forms

For more than 30 years, JGL has been growing and developing its business globally. Thanks to continued investments in R&D, production facilities and technology, it currently ranks among the leading manufacturers of sterile pharmaceutical forms in the EU. The business, research and manufacturing complex JGL Pharma Valley in Rijeka combines best practices in production process management, state-of-the-art technology in pharmaceutical production and high environmental standards.

In September 2023, company celebrated the completion of the investment in the INTEGRA capital project, which featured the unveiling of new laboratories for research, development and quality control, a pilot plant and a sterile production line for drops and sprays set to increase our production capacity by 60 per cent. JGL's new robotic logistics and distribution centre with 17,500 pallet spaces in Rijeka's Kukuljanovo business zone was also presented.

### Nearly 85 Per Cent of Revenue Comes From Exports

In 2022, the JGL Group generated a total of EUR 190 million in revenue, of which EUR 181.3 million was operating revenue, and EUR 32.4 million in operating profit (EBITDA). Nearly 85 per cent of the company's core earnings is generated outside of Croatia, and JGL Group employs just over a thousand people.

The company's leading export brand is Aqua Maris, launched in 1999, which consists of 100% natural products based on seawater from the Adriatic, used for the prevention and treatment of upper respiratory tract diseases. Other key brands include Vizol S, Meralys, Aknekutan and Dramina.

# neu.

a Solenis company

[www.solenis.com](http://www.solenis.com)

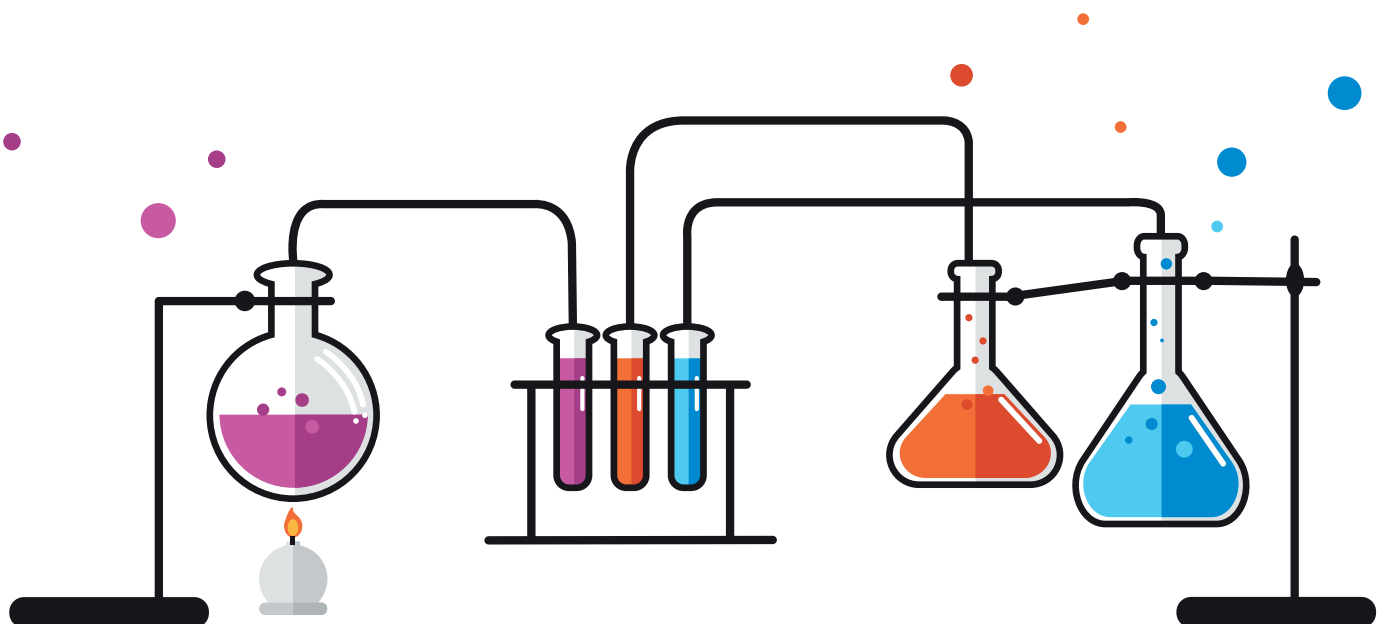



## Join our team of #SelvitaSuperHeroes

Selvita in Zagreb is part of **Selvita Group**, one of Europe's largest preclinical **contract research organizations** offering preclinical **drug discovery** and **drug development** services.

We solve scientific puzzles with **passion** and **commitment**, and what is most important, we do it **together**. Every day we strive to make an impact on people's lives.



### What makes us unique?



State-of-the-art  
laboratories



Over 70 years of experience  
within the industry



Top-notch quality  
of our research



Professional development  
and cooperation with  
experienced mentors



Daily collaborations  
with scientists across  
the world



A team of dedicated  
experts who believe that  
science opens the door  
to the future

**Visit our website**

<https://careers.selvita.com/>

**Contact us:**

[careers@selvita.com](mailto:careers@selvita.com)

**Selvita d.o.o.**

Prilaz baruna Filipovića 29  
10000 Zagreb  
tel: +385 1 8886300

# Doprinos društvu kroz znanost i tehnologiju



## Najbolje za vaše potrebe!

Shimadzu je vodeći svjetski proizvođač analitičkih i mjernih instrumenata.

Nudimo sofisticirana i optimalna rješenja neophodna za istraživanje, razvoj i kontrolu kvalitete.

## Naša rješenja!

- ✓ Analiza ukupnog organskog ugljika
- ✓ Tekućinska kromatografija

- ✓ Plinska kromatografija
- ✓ Spektrometrija masa
- ✓ Elementarna analiza
- ✓ Molekularna spektroskopija
- ✓ Ispitivanje materijala
- ✓ Potrošni materijal
- ✓ Softverska rješenja
- ✓ Servisna i aplikativna podrška
- ✓ Edukacije



## KONTAKTIRAJTE NAS!

Shimadzu d.o.o.  
tel: +385 1 6185 777

Zavrtnica 17  
10 000 Zagreb

shimadzu@shimadzu.hr  
www.shimadzu.hr



**ANALYTICAL  
INTELLIGENCE**

MERCK

# six life science brands

at the nucleus of innovation

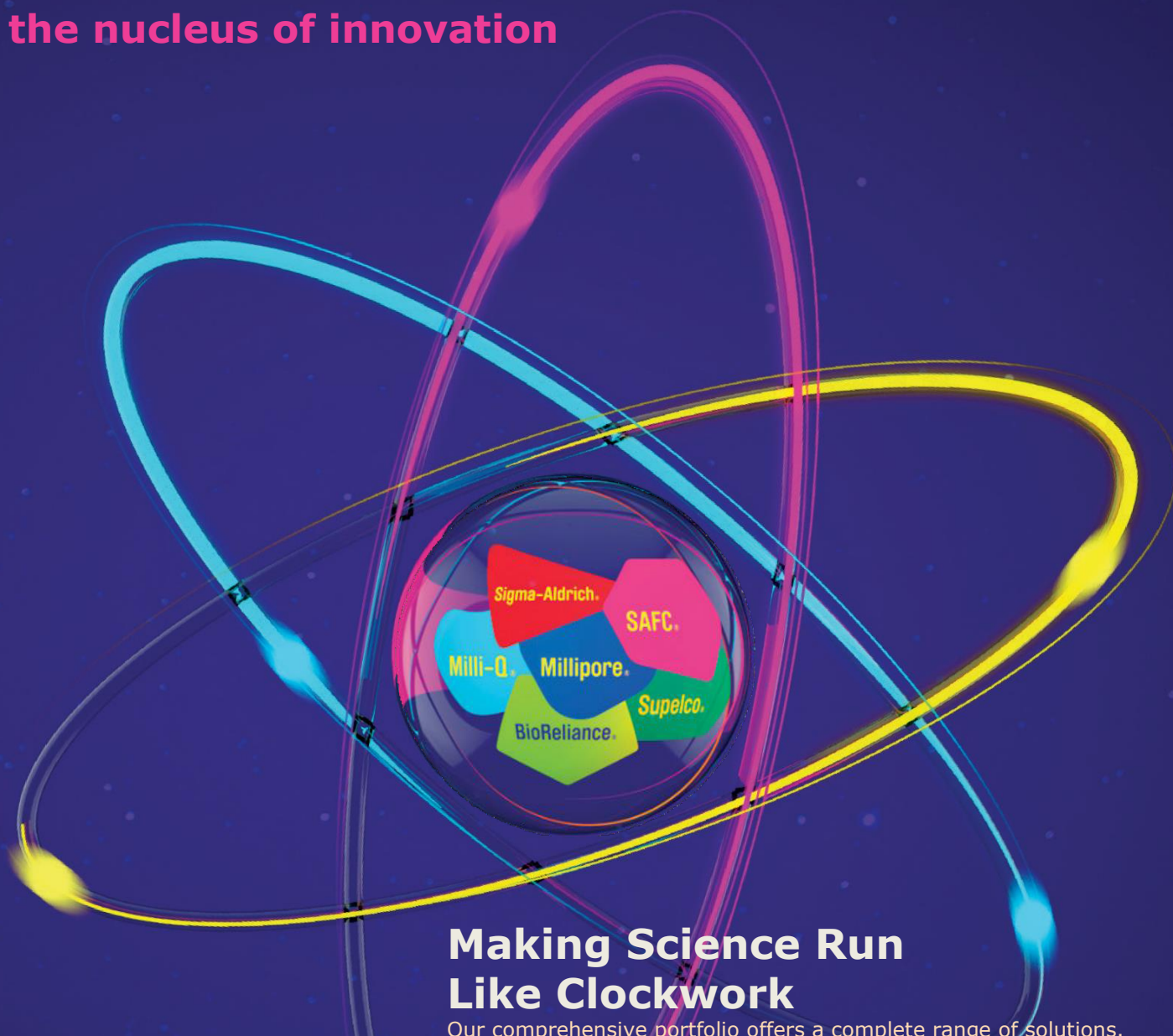

## Making Science Run Like Clockwork

Our comprehensive portfolio offers a complete range of solutions, backed by our deep expertise in science and technology, to help you thrive in your vital work.

Supelco® portfolio provides a comprehensive range of products and services for chromatography, spectroscopy, titration and many other techniques in analytical chemistry.

Sigma-Aldrich® portfolio provides lab and production materials and support to serve you in your quest for scientific advancement.

With an ever-expanding portfolio, we're here to help you make the leap from impossible dream to reality.

Explore our complete offering at [Sigma-Aldrich.com](http://Sigma-Aldrich.com)



The life science business of Merck, KGaA, Darmstadt, Germany operates as MilliporeSigma in the U.S. and Canada.

For more information please contact Merck: [kemija@merckgroup.com](mailto:kemija@merckgroup.com)

Dodatno se upoznajte s našim poslovanjem na [www.pliva.hr](http://www.pliva.hr) a pozivamo vas da se povežete s nama i putem društvenih mreža.



## Jeste li se ikada zapitali kako bi bilo raditi u PLIVI?

PLIVA veliku pažnju posvećuje suradnji s akademskom zajednicom te aktivno sudjelujemo u brojnim studentskim projektima. Prve korake suradnje s PLIVOM zainteresirani studenti mogu ostvariti putem stručne prakse, a kroz dugu tradiciju stipendiranja značajna sredstva usmjeravamo u stipendiranje vrhunskih studenata. Uspješna suradnja sa studentima motivira i usmjerava naša daljnja nastojanja u pridonosa životu i osiguravanju pozitivnog imidža PLIVE među zajednicama studenata.

# Čitavo stoljeće posvećeni brizi za zdravlje.

[pliva.hr](http://pliva.hr)



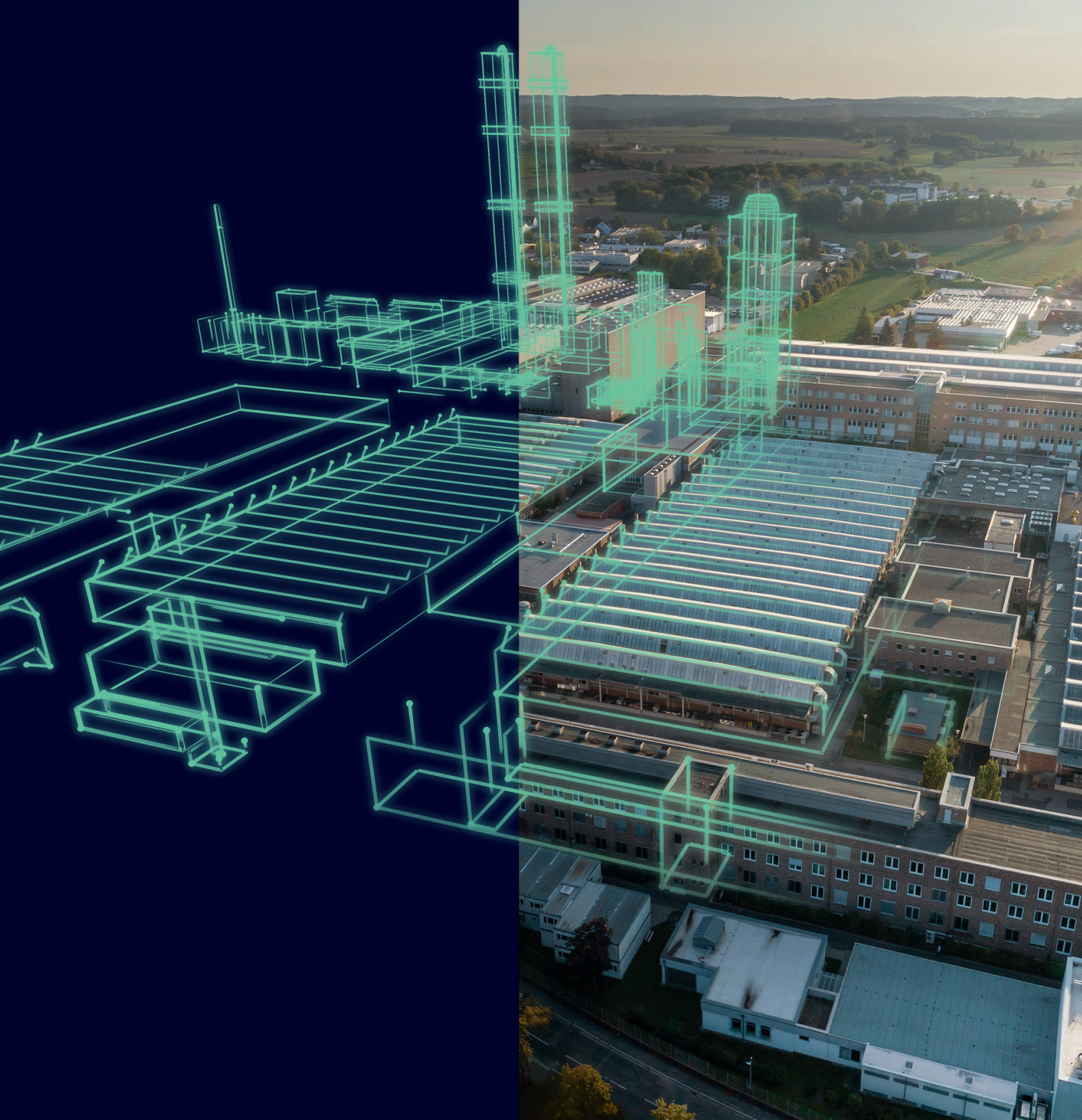

# | Preobrazimo svakodnevicu!

Naša tehnologija oblikuje svijet u kojem želimo živjeti. Preobrazimo zajedno vaše aktivnosti, zajedno transformirajmo svakodnevni život!

[siemens.hr](https://www.siemens.hr)

**SIEMENS**

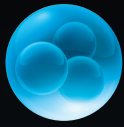

**xellia**  
PHARMACEUTICALS



## A global leader in providing **anti-infective treatments** and other **critical care therapies** for serious and often life-threatening conditions

Xellia is a global leader in providing critical care therapies and anti-infective treatments against serious and often life-threatening infections; ranging from Active Pharmaceutical Ingredients (APIs) to drug products (FDFs), and from generics to specialty pharmaceuticals. Customers depend on us for reliable supply and consistent quality, and to exemplify responsible manufacturing, production, and research and development that promote long-term sustainability.

Headquartered in Copenhagen, Denmark and owned by Novo Holdings A/S, Xellia Pharmaceuticals has more than 1800 employees globally. From state-of-the-art manufacturing sites in the U.S., China, Denmark and Hungary to R&D sites in Norway and Croatia and commercial operations across Europe, Asia, the Middle East and North America; Xellia Pharmaceuticals' strong market position is built on more than 120 years of pharmaceutical industry experience. With the patient in focus, Xellia is building a pipeline of value-added critical care therapies which aim to enhance patient care by providing convenience and ease of use for healthcare professionals.

Further information about Xellia can be found at: [www.xellia.com](http://www.xellia.com)



Connect with us on LinkedIn



***chemengineering***

an Open Access Journal by MDPI

*ChemEngineering* (ISSN 2305-7084) is an international, peer-reviewed, open access journal on chemical engineering, which combines chemistry, physics and life science with mathematics and economics to produce, transform, transport and properly use chemicals and energy. Our aim is to encourage scientists and engineers to publish their experimental and theoretical results in as much detail as possible.

Website: <https://www.mdpi.com/journal/ChemEngineering>

**Publisher | Izdavač:**  
**Hrvatsko društvo kemijskih**  
**inženjera i tehnologa (HDKI)**  
**2024**