



HRVATSKI SKUP KEMIČARA I KEMIJSKIH INŽENJERA

s međunarodnim sudjelovanjem | 4. simpozij "Vladimir Prelog"

9. – 12. travnja 2019. • Šibenik, Amadria Park (Solaris)

CROATIAN MEETING OF CHEMISTS AND CHEMICAL ENGINEERS

with international participation | 4th Symposium "Vladimir Prelog"

April 9–12, 2019 • Šibenik, Amadria Park (Solaris), Croatia

ORGANIZATORI / ORGANIZERS:

Hrvatsko društvo kemijskih inženjera i tehnologa
Croatian Society of Chemical Engineers

Hrvatsko kemijsko društvo
Croatian Chemical Society

Knjiga sažetaka

Book of Abstracts

Šibenik, Amadria Park (Solaris)



www.26hsiki.org



Fotografija Šibenika: Zvonimir Katančić | dizajn: Zdenko Blažeković



Doprinos društvu kroz znanost i tehnologiju

Svrha je služiti i štititi temelj života čovječanstva i prirode.

Shimadzu nudi veliki broj različitih proizvoda, preko analitičke i mjerne opreme do velikih medicinskih uređaja. Odjel Analitike je jedan od vodećih svjetskih proizvođača analitičkih instrumenata kao i opreme za praćenje okoliša. Shimadzu analitički instrumenti idealna su rješenja za farmaciju, kemiju, petrokemiju, biogoriva, energiju, hranu, pića, poljoprivredu, okuse, mirise, okoliš, zdravlje, biomedicinske znanosti, industriju i automobile. **Excellence in Science** odražava težnju i stav da na zahtjeve korisnika odgovaramo ponudom superiorne tehnologije svjetske klase.

Shimadzu d.o.o., Zavrtnica 17, Zagreb
tel: +385 (0)1 61 85 777
<https://www.shimadzu.hr/analytics>

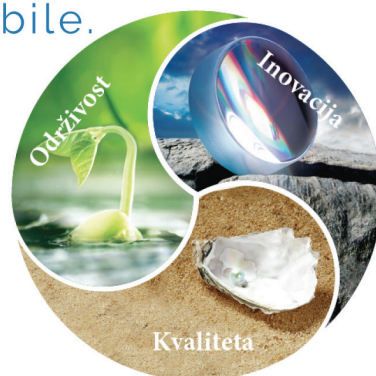

LOOK AT THE WORLD THROUGH OUR OPTICS



LONG LIFETIME | HIGH PERFORMANCE | WIDE RANGE OF ACCESSORIES | EASY OPERATION

WE SELECT FROM OUR PORTFOLIO:

VERTEX Series FTIR Spectrometers

- The best performing R&D spectrometers on market
- The highest sensitivity with vacuum below 0.2 hPa
- Possible combination with microscopy, Raman, TGA etc.
- Spectral range extension from FIR/THz to UV/VIS region (3–50.000 cm^{-1})
- Time-resolved spectroscopy - up to 110 spectra/s, time resolution up to 2.5 ns

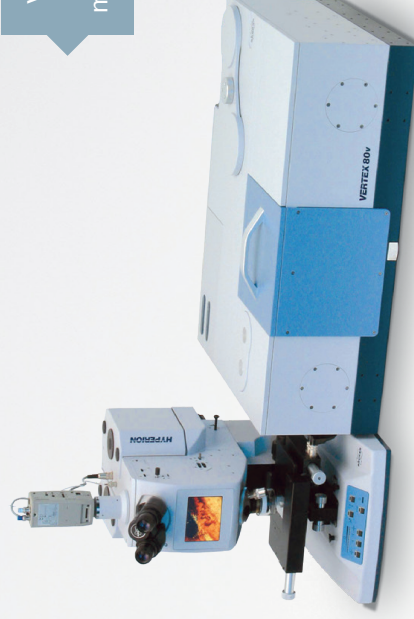

Vacuum FTIR spectrometer
VERTEX 80v with FTIR
microscope HYPERION 3000

Advanced Dispersive Raman Microscope SENTERRA II

- Up to 4 excitation lasers in range 488-1064 nm
- Possible combination with FT-Raman
- Fast a simple mapping up to 100 spectra/s
- Spatial resolution up to 500nm

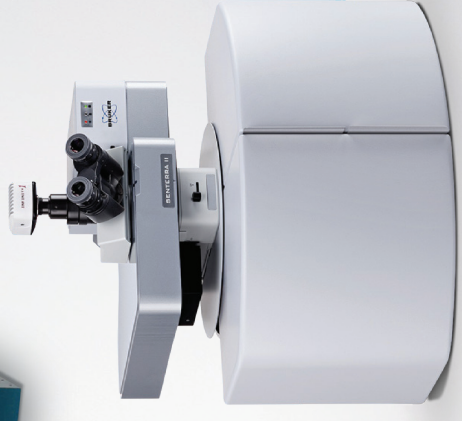

SENTERRA II
Raman
Microscope



26. hrvatski skup kemičara i kemijskih inženjera
s međunarodnim sudjelovanjem
4. simpozij Vladimir Prelog
9. – 12. travnja 2019.
Šibenik, Amadria park (Solaris)

Knjiga sažetaka

26th Croatian Meeting of Chemists and Chemical Engineers
with international participation
4th Symposium Vladimir Prelog
9–12 April 2019
Šibenik, Amadria park (Solaris), Croatia

Book of Abstracts

Znanstveno-organizacijski odbor ***Scientific and Organizing Committee***

Aleksandra Sander (predsjednica)
Mario Vazdar (dopredsjednik)
Jasna Prlić Kardum (tajnica)
Danijela Barić
Zdenko Blažeković
Marijana Đaković
Vesna Gabelica Marković
Nives Galić
Zvonimir Katančić
Borislav Kovačević
Hrvoje Kušić
Sanja Lučić Blagojević
Snježana Osmak
Jelena Parlov Vuković
Marko Rogošić
Marin Roje
Vesna Tomašić
Dubravka Turčinović
Lidija Varga-Defterdarović
Miroslav Žegarac
Olgica Martinis

Lokalni organizacijski odbor ***Local Organizing Committee***

Nenad Kuzmanić
Sanja Slavica Matešić
Melinda Grubišić Reiter

Međunarodni organizacijski odbor ***International Organizing Committee***

Albin Pintar, Slovenia
Saša Omanović, Canada
Valerio Causin, Italy
Andrea Katović, Italy

Organizatori / Organizers

Hrvatsko društvo kemijskih inženjera i tehnologa / Croatian Society of Chemical Engineers
Hrvatsko kemijsko društvo / Croatian Chemical Society

Tajništvo skupa / Secretariat of the Meeting

Jasna Prlić Kardum
Fakultet kemijskog inženjerstva i tehnologije Sveučilišta u Zagrebu
Marulićev trg 19,
HR-10 000, Zagreb,
Hrvatska
Tel.: 01/4597-223
e-pošta: hskiki@fkit.hr
www.26hskiki.org

Grafička priprema programa / Design & Layout

Zdenko Blažeković

IMPRESUM

Organizatori / Organizers

Hrvatsko društvo kemijskih inženjera i tehnologa
Croatian Society of Chemical Engineers
Hrvatsko kemijsko društvo
Croatian Chemical Society

Izdavač / Published by

Hrvatsko društvo kemijskih inženjera i tehnologa
Croatian Society of Chemical Engineers

Urednici / Editors

Nives Galić / Marko Rogošić

Grafička priprema / Design & Layout

Zdenko Blažeković

Recenzenti sažetaka / Reviewers

Danijela Barić	Marko Rogošić
Marijana Đaković	Marin Roje
Nives Galić	Aleksandra Sander
Zvonimir Katančić	Vesna Tomašić
Borislav Kovačević	Lidija Varga Defterdarović
Hrvoje Kušić	Mario Vazdar
Jasna Prlić Kardum	

ISBN: 978-953-6894-67-3

Mjesto održavanja Skupa / Meeting Venue

Šibenik
Amadria Park (Solaris)
Hoteli Solaris 86
Šibenik
Croatia
Tel: +385 (0) 22 363 951
Fax: + 385 22 363 945
<https://www.amadriapark.com/location/sibenik>

Zagreb, 2019.



Pod visokim pokroviteljstvom Predsjednice RH Kolinde Grabar-Kitarović
Under the high auspices of Kolinda Grabar-Kitarović,
President of the Republic of Croatia



Ministarstvo znanosti i obrazovanja
Ministry of Science and Education



Ministarstvo zaštite okoliša i energetike
Ministry of Environment and Energy



Akademija tehničkih znanosti Hrvatske
Croatian Academy of Engineering



Hrvatska gospodarska komora
Croatian Chamber of Economy



Hrvatski inženjerski savez
Croatian Association of Engineers



Institut Ruđer Bošković
Ruđer Bošković Institute



Sveučilište u Zagrebu
University of Zagreb



Šibensko-kninska županija
Šibenik-Knin County



Grad Šibenik
City of Šibenik



Međunarodna unija za čistu i primijenjenu kemiju
International Union of Pure and Applied Chemistry

ZLATNI
SPONZOR
GOLDEN
SPONSOR



XELLIA d. o. o., Zagreb, Croatia

ZLATNI
SPONZOR
GOLDEN
SPONSOR



PLIVA Hrvatska d. o. o., Zagreb, Croatia

SREBRNI
SPONZOR
SILVER
SPONSOR



OPTIK INSTRUMENTS s.r.o., Czech Republic

SREBRNI
SPONZOR
SILVER
SPONSOR



SHIMADZU d. o. o., Zagreb, Croatia

BRONČANI
SPONZOR
BRONZE
SPONSOR



ALPHACHROM d. o. o., Zagreb, Croatia

BRONČANI
SPONZOR
BRONZE
SPONSOR



CEMEX Hrvatska d. d., Kaštel Sućurac, Croatia

BRONČANI
SPONZOR
BRONZE
SPONSOR



CHEMICAL ABSTRACTS SERVICE, USA

BRONČANI
SPONZOR
BRONZE
SPONSOR



INA-Industrija nafte, d. d., Zagreb, Croatia

BRONČANI
SPONZOR
BRONZE
SPONSOR



LABTIM ADRIA d. o. o., Zagreb, Croatia

SPONZOR
SPONSOR

AD PLASTIK d. d., Solin, Croatia

SPONZOR
SPONSOR

AGROPROTEINKA d. d., Sesvete, Croatia

SPONZOR
SPONSOR

ALFA d. d., Zagreb, Croatia

SPONZOR
SPONSOR

DECHRA – GENERA d. d., Rakov Potok, Croatia

SPONZOR
SPONSORFAKULTET KEMIJSKOG INŽENJERSTVA I
TEHNOLOGIJE
Sveučilišta u Zagrebu
FACULTY OF CHEMICAL ENGINEERING AND
TECHNOLOGY
*of the University of Zagreb*SPONZOR
SPONSOR

PROFIL KLETT d. o. o., Zagreb, Croatia

SPONZOR
SPONSOR

ŠKOLSKA KNJIGA d. d., Zagreb, Croatia

IZLAGAČ
EXHIBITOR

ANAS d. o. o., Zagreb, Croatia

IZLAGAČ
EXHIBITOR

BIA d. o. o., Ljubljana, Slovenia

IZLAGAČ
EXHIBITOR

KEFO d. o. o., Sisak, Croatia

IZLAGAČ
EXHIBITOR

KEMOLAB d. o. o., Zagreb, Croatia

IZLAGAČ
EXHIBITOR

KOBIS d. o. o., Zagreb, Croatia

IZLAGAČ
EXHIBITOR

LABOMAR d. o. o., Zagreb, Croatia

IZLAGAČ
EXHIBITORLKB Vertriebs Ges.m.b.H.,
Podružnica Zagreb
Office in Zagreb, CroatiaIZLAGAČ
EXHIBITOR

MEDIC d. o. o., Zagreb, Croatia

IZLAGAČ
EXHIBITOR

METTLER TOLEDO d. o. o., Zagreb, Croatia

IZLAGAČ
EXHIBITOR

PRIMALAB d. o. o., Zabok, Croatia

IZLAGAČ
EXHIBITOR

RENACON d. o. o., Zagreb, Croatia

IZLAGAČ
EXHIBITORROYAL SOCIETY OF CHEMISTRY, Cambridge,
UKIZLAGAČ
EXHIBITOR

RU-VE d. o. o., Sveta Nedelja, Croatia

IZLAGAČ
EXHIBITOR

TEHNOMODELI d. o. o., Zagreb, Croatia

IZLAGAČ
EXHIBITOR

VWR™, part of avantor, USA

DONATOR
DONOR

FIDELTA d. o. o., Zagreb, Croatia

DONATOR
DONOR

JGL d. d., Rijeka, Croatia

Prof. Aleksandra Sander

Predsjednica Znanstveno-organizacijskog odbora

Chair of the Scientific and Organizing committee

**Uvodna riječ / Foreword**

U ime znanstveno-organizacijskog odbora iznimna mi je čast i zadovoljstvo pozdraviti Vas na **26. hrvatskom skupu kemičara i kemijskih inženjera (26HSKIKI)** s međunarodnim sudjelovanjem koji se održava od 9. do 12. travnja 2019. u Šibeniku, Amadria park (Solaris), u organizaciji Hrvatskoga društva kemijskih inženjera i tehnologa i Hrvatskoga kemijskoga društva. Skup se tradicionalno održava svake dvije godine od 1969. tako da se 2019. obilježava i jubilarnih 50 godina skupa. U sklopu Skupa svečano će se obilježiti i 100. obljetnica nastave kemijskog inženjerstva u Zagrebu, čiju tradiciju danas ponosno nosi Fakultet kemijskog inženjerstva i tehnologije Sveučilišta u Zagrebu. Na Skupu će se okupiti znanstvenici i stručnjaci sa sveučilišta, iz istraživačkih instituta, škola i industrije, kako iz Hrvatske tako i iz inozemstva, koji će kroz pet sekcija (Kemija, Kemijsko i biokemijsko inženjerstvo, Materijali, Zaštita okoliša i Obrazovanje) izmijeniti iskustva i prezentirati svoja najnovija dostignuća te na taj način proširiti nova znanja, ideje i tehnologije u službi inženjerstva i razvoja gospodarstva. Tijekom četiri radna dana, sudionici iz 20 zemalja održat će 6 plenarnih, 16 pozvanih te 30 sekcijских predavanja uz 177 posterskih priopćenja. Hvala pokroviteljima, sponzorima i izlagačima što su prepoznali važnost ovoga skupa te ga svojim sudjelovanjem podupiru. Želimo Vam ugodan boravak u Šibeniku uz mnoštvo razmijenjenih ideja, ostvarenih kontakata te bogatu znanstvenu i stručnu suradnju.

*On behalf of the Scientific and Organizing Committee, it is a great honour and privilege to welcome you to Šibenik, Amadria Park (Solaris) to the **26th Croatian Meeting of Chemists and Chemical Engineers (26HSKIKI)** with international participation, held from 9 – 12 April 2019. Jointly organized by the Croatian Society of Chemical Engineers and the Croatian Chemical Society, this meeting has traditionally been held on a biannual basis since 1969. This year, 2019, marks 50 years of our Meeting, on the occasion of which we are also celebrating a 100-year anniversary of chemical engineering teaching in Zagreb, a tradition proudly upheld by the Faculty of Chemical Engineering and Technology, University of Zagreb. Through its five sections – Chemistry, Chemical and Biochemical Engineering, Material Science, Environmental Protection and Education – this meeting aims to enable scientists and experts from universities, research institutes, schools and industry from Croatia and abroad to exchange experiences and present their recent achievements, thus introducing new knowledge, ideas and technologies into the fields of engineering and economic development. During four working days, the participants from 20 countries will hold 6 plenary lectures, 16 invited lectures and 30 section lectures as well as 177 poster presentations. We wish to thank our sponsors and exhibitors for recognizing the significance of this Meeting and for supporting it with their valued participation. We also wish you a pleasant stay in Šibenik and lots of benefits from a multitude of ideas exchanged, contacts made and successful scientific and expert collaboration established.*

**Aleksandra
Sander**

Do you write, review or edit scientific papers?

Are you planning to do so?

Royal Society of Chemistry workshop with *RSC Advances* editor **Dr Andrew Shore**

10 April, 14.00 – 14:45
26th HSKIKI, Šibenik

- Feel prepared at every step of the publishing process
- Get clarity on your responsibilities as an expert reviewer
- Hear our editors' top tips for getting noticed and making an impact

You can also speak to us at our stand



SADRŽAJ

CONTENTS

	PLENARNA PREDAVANJA / PLENARY LECTURES	1
PL-1	Hermann J. FEISE Ovladavanje digitaliziranim kemijskim inženjerstvom <i>Mastering digitized chemical engineering</i>	2
PL-2	Sven HENNING Metode elektronske mikroskopije za istraživanje morfologije i mikromehaničkih procesa u polimerima <i>Electron microscopic methods to investigate morphology and micromechanical processes of polymers</i>	3
PL-3	Len BARBOUR Strukturalna fleksibilnost u čvrstom stanju – implikacije za porozne materijale <i>Structural flexibility in the solid state – implications for porous materials</i>	4
PL-4	Dionysios (Dion) D. DIONYSIOU Obrada “novih zagađivala” u vodi homogenim i heterogenim naprednim oksidacijskim procesima i uporaba tako obrađene vode <i>Treatment of contaminants of emerging concern in water and water reuse using homogeneous and heterogeneous advanced oxidation processes</i>	5
PL-5	Ivo LEITO Kako maksimalno iskoristiti dostupne podatke o pKa vrijednostima u nevodnim otapalima? <i>How to make maximum use of the available pKa data in non-aqueous solvents?</i>	6
PL-6	Ivo STARÝ Helikalni kiralni aromati: sinteza, svojstva i primjene <i>Helically chiral aromatics: their synthesis, properties and applications</i>	7
	POZVANA PREDAVANJA / INVITED LECTURES	8
IL-1	Jasminka POPOVIĆ, Aleksandra Djurišić, Ivor Lončarić, Luca Grisanti, Martina Vrankić, Željko Skoko Od racionalnog strukturnog dizajna do poboljšane učinkovitosti i stabilnosti svjetlosnih dioda: 2D i kvazi-2D hibridni perovskiti <i>From rational structural design to enhanced efficiency and stability of light-emitting diodes: 2D and quasi 2D hybrid perovskites</i>	9
IL-2	Krunoslav UŽAREVIĆ In situ praćenje mehanokemijskih reakcija za daljnji razvoj kemije čvrstog stanja <i>In situ monitoring of mechanochemical reactions for new advances in solid-state chemistry</i>	10
IL-3	Bakhtiyor RASULEV Primjena kombiniranih metoda računalne kemije i keminformatike u procjeni svojstava nanomaterijala <i>Application of combined computational chemistry and cheminformatics methods in properties assessment of nanomaterials</i>	11
IL-4	Muhamed SUĆESKA Teorijsko izračunavanje performansi eksploziva <i>Theoretical calculation of explosive performance</i>	12
IL-5	Predrag NOVAK Kako spektroskopija NMR može odrediti vezne epitope makrolidnih antibiotika? <i>How can NMR spectroscopy reveal binding epitopes of macrolide antibiotics?</i>	13
IL-6	Gordana MATIJAŠIĆ 3D-tisak kao tehnologija za pripremu oralnih doziranih oblika kontroliranog oslobađanja <i>3D print as a technology for the preparation of oral dosage forms of controlled release</i>	14
IL-7	Klaus ZANGGER Proširenje djelokruga NMR spektroskopije – visoka rezolucija i izravno promatranje kemijskih reakcija <i>Extending the scope of NMR spectroscopy – high resolution and direct reaction monitoring</i>	15
IL-8	Sanja TOMIĆ, Antonija Tomić, Sara Matić, Mihaela Matovina Nekoliko lica ljudske dipeptidil-peptidaze III <i>Several faces of human dipeptidyl peptidase III</i>	16
IL-9	Mira PETROVIĆ, Yaroslav Verkh, Mira Celic, Meritxell Gros Praćenje tragova organskih zagađivala tijekom procesa obrade voda – od ciljane i pretražne do sveobuhvatne analize <i>Monitoring trace organic contaminants in water treatment processes – from target analysis, suspect screening to non target analysis</i>	17
IL-10	Marina TRGO Prirodni zeoliti u zaštiti okoliša <i>Natural zeolites in environmental protection</i>	18

IL-11	Marko MIHOVILOVIC Automatsko vođenje laboratorijskih procesa – primjeri s granice između kemije i biologije <i>Lab-automation – showcases from the chemistry-biology interface</i>	19
IL-12	Stela JOKIĆ Superkritična CO ₂ ekstrakcija bioaktivnih komponenti iz biljnog materijala <i>Supercritical CO₂ extraction of plant biologically active compounds</i>	20
IL-13	Olivier THOMAS Morski crvi kao iznenađujući izvor kemijske raznolikosti <i>Marine worms as a source of unexpected chemical diversity</i>	21
IL-14	Marina ŠEKUTOR Površinska orijentacija i reaktivnost dijamantoidnih spojeva <i>On-surface orientation and reactivity of diamondoid compounds</i>	22
IL-15	Tomislav FRIŠČIĆ Mehanokemija i zelena kemija – drugačiji pristup kemiji <i>Mechanochemistry and green chemistry – thinking about chemistry in a different way</i>	23
IL-16	Tajana PREOČANIN Integrirani zadaci iz kemije u školi, na natjecanju i na državnoj maturi <i>Integrated chemistry problems in the class, at the competition and final examination</i>	24
	USMENA PRIOPĆENJA / ORAL PRESENTATIONS	25
O-1	Antun BARIŠIĆ, Johannes Lutzenkirchen, Gregory Lefevre, Tajana Preočanin Termodinamika procesa na međupovršini politetrafluoroetilen / vodena otopina elektrolita <i>Thermodynamics of polytetrafluoroethylene / aqueous electrolyte solution interface</i>	26
O-2	Ante BUBIĆ, Branimir Bertoša, Ivana Lešćić Ašler, Marija Luić Računalna i eksperimentalna karakterizacija adenilosukcinat-sintetaze iz <i>Helicobacter pylori</i> <i>Computational and experimental characterization of adenilosuccinate synthetase from Helicobacter pylori</i>	27
O-3	Luka BILIĆ, Danijela Barić, Radha Dilip Banhatti, David M. Smith, Borislav Kovačević Analiza vezanja glicerola u aktivnom mjestu B ₁₂ -ovisne diol dehidrataze; implikacije na katalizu i inhibiciju <i>Analysis of glycerol binding within the active site of B₁₂-dependent diol dehydratase; implications for catalysis and inhibition</i>	28
O-4	Magdalena KRALJ, Irena Sović, Ivan Halasz Mehanokemijska sinteza grafenova oksida ugodivog stupnja oksidacije <i>Mechanochemical synthesis of graphene oxide with variable degree of oxidation</i>	29
O-5	Marta Da Pian, Michele Maggini, G. Julius Vancso, Edmondo M. Benetti, Valerio CAUSIN Načini agregiranja poly-3-(heksil-tiofena) u prisutnosti metilnog estera [6,6]-fenil-C61-maslačne kiseline (PCBM) ili poli(ε-kaprolaktona) <i>Aggregation paths of poly-3-(hexyl thiophene) in the presence of either [6,6]-phenyl-C61-butyric acid methyl ester (PCBM) or poly(ε-caprolactone)</i>	30
O-6	Ada SACCA, Alessandra Carbone, Rolando Pedicini, Irene Gatto, Enza Passalacqua Razvoj kompozitnih membrana od Nafiona i YSZ-zeolita poboljšane stabilnosti za drastične uvjete u gorivim ćelijama s polimernim elektrolitom <i>Development of composite Nafion-YSZ membranes with improved stability for drastic conditions in polymer electrolyte fuel cells</i>	31
O-7	Sanda RONČEVIĆ, Ivan Nemet Spektrometrija plazme u analizi sorpcije specija metala na neutralnim nanočesticama željeza <i>Plasma spectrometry in analysis of metal species sorption on zero-valent iron nanoparticles</i>	32
O-8	Ivan NEMET, Sanda Rončević Uloga spektrometrije plazme u profiliranju uzoraka arheometalurškog željeza <i>The role of plasma spectrometry in archaeometallurgical iron samples profiling</i>	33
O-9	Ivana VRCA, Azra Đulović, Franko Burčul, Tea Bilušić, Ivica Blažević Udio izotiocijanata u gorušičinu ulju sjemenki bijele, smeđe i crne gorušice nakon klasičnih i modernih tehnika ekstrakcije <i>Isothiocyanate content in seed mustard oils from white, brown and black mustard after conventional and modern extraction techniques</i>	34
O-10	Želimir KURTANJEK Objasnidbeni modeli zasnovani na umjetnoj inteligenciji za vođenje procesa u kemijskom inženjerstvu <i>Explanatory artificial intelligence models for process control in chemical engineering</i>	35

O-11	Anita BAŠIĆ, Marija Ćosić, Antonija Čelan, Sandra Svilović Utjecaj vrste miješala i razbijala virova na ionsku izmjenu bakra u kotlastom reaktoru <i>Effects of impeller type and presence of baffles on ion exchange in a batch reactor</i>	36
O-12	Marija LUKIĆ, Domagoj Vrsaljko Utjecaj dimenzija milireaktora na konverziju suncokretova ulja u FAME <i>Impact of millireactor dimensions on conversion of sunflower oil to FAME</i>	37
O-13	Marijana ĐAKOVIĆ, Mateja Pisačić, Nikolina Penić Kristalni koordinacijski polimeri s fleksibilnim odzivom na primjenu vanjske mehaničke sile <i>Crystalline coordination polymers with flexible response to applied external mechanical force</i>	38
O-14	Krešimir MOLČANOV, Biserka Kojić-Prodić, Vladimir Stilinović, Zhongyu Mou, Miklos Kertesz, Bruno Landeros-Rivera, Jesús Hernández-Trujillo Na granici između inter- i intramolekulske: dvoelektronske multicentrične kovalentne veze <i>On the border between inter- and intramolecular: two-electron multicentric covalent bonding</i>	39
O-15	Lidija KANIŽAJ, Krešimir Molčanov, Marijana Jurić Različite arhitekture heterometalnih spojeva s 1,10-fenantrolinom koji sadrže oksalatne i kloranilatne mostove <i>Different architectures of oxalate- and chloranilate-bridged heterometallic compounds with 1,10'-phenanthroline</i>	40
O-16	Ivana JAKOVljević, Zdravka Sever Štrukil, Ranka Godec, Gordana Pehneć Sezonske varijacije policikličkih aromatskih ugljikovodika u PM1 frakciji lebdećih čestica <i>Seasonal variations of polycyclic aromatic hydrocarbons in PM1 particle fraction</i>	41
O-17	Maja LEVAK ZORINC, Petra Burić, Darija Domazet Jurašin, Maja Dutour Sikirić, Niko Bačić, Nevenka Mikac, Florian Meier, Roland Drexel, Daniel M. Lyons Stabilizacija i učinak veličine nanočestica srebra omotanih biološkim omotačima u umjetnoj morskoj vodi <i>Biocorona-derived stabilization of silver nanoparticles in artificial seawater and the effects of nanoparticle size</i>	42
O-18	Maja ZEBIĆ AVDIČEVIĆ, Krešimir Košutić, Slaven Dobrović Karakterizacija komercijalnih keramičkih ultrafiltracijskih membrana i istraživanje pada fluksa <i>Characterization of commercial ceramic ultrafiltration membranes and flux decline study</i>	43
O-19	Valentina MILAŠINOVIĆ, Krešimir Molčanov 3-nitro-6-kloro-2,5-dihidroksikinon (nitrokloranilna kiselina) – novi kinonski spoj s velikim potencijalom dizajniranja koordinacijskih polimera <i>3-nitro-6-chloro-2,5-dihydroxyquinone (nitrochloranilic acid) – a novel quinoid compound with a great potential for design of coordination polymers</i>	44
O-20	Edi TOPIĆ, Mirta Rubčić, Jana Pisk, Višnja Vrdoljak Uvid u strukturu kompleksa i polioksomolibdatâ izvedenih iz asimetričnih karbohidrazona <i>Structural insights into complexes and polyoxomolybdate salts derived from asymmetric carbohydrazones</i>	45
O-21	Sanja BURAZER, Jasminka Popović, Fabrice Morelle, Yaroslav Filinchuk, Radovan Černý Mehanokemijska sinteza i kristalne strukture nove skupine miješanih metalnih imidazolata AMgIm ₃ , A = Na, K <i>Mechanochemical synthesis and crystal structure of new group of mixed-metal imidazolates AMgIm₃, A = Na, K</i>	46
O-23	Anamarija MITAR, Jasna Prlić Kardum, Dajana Kučić Grgić Ekstrakcija i ispitivanje stabilnosti fenolnih spojeva primjenom prirodnih niskotemperaturnih eutektičnih otapala <i>Extraction and stability analysis of phenolic compounds using natural deep eutectic solvents</i>	47
O-24	Nora TIR, Lina Heistinger, Brigitte Gasser, Diethard Mattanovich Ugradnja neprirodnih aminokiselina u rekombinantne proteine pomoću kvasca <i>Pichia pastoris</i> <i>Introduction of unnatural amino acids in recombinant proteins with the yeast Pichia pastoris</i>	48
O-25	Lela PINTARIĆ, Martina Burštinski, Željka Bućan, Ana Vrsalović Presečki, Iva Rezić Enzimatska sinteza nanočestica željezovih oksida korištenjem enzima ureaze <i>Enzymatic synthesis of the iron-oxide nanoparticles using enzyme urease</i>	49
O-26	Katarina VAZDAR, Ivanka Jerić Amino-β-laktami u Ugijevoj reakciji: učinkovita metoda za pripremu funkcionaliziranih peptidomimetika <i>Amino-β-lactams in Ugi reaction: an efficient method for preparation of functionalized peptidomimetics</i>	50

O-27	Saša OPAČAK, Berislav Perić, Darko Babić, Mario Cindrić, Amela Hozić, Srećko I. Kirin Supramolekulska kemija 1,1'-disupstituiranih ferocenskih amida <i>Supramolecular chemistry of 1,1'-disubstituted ferrocene amides</i>	51
O-28	Vitomir ŠUNJIĆ Dostignuća organske stereokemije u Hrvatskoj i Prelogova škola <i>Achievements of organic stereochemistry in Croatia and Prelog school</i>	52
O-29	Andreja KAKŠA Analiza projekta „ZadarZaDar“ – prednosti i mane <i>Analysis of the Project “ZadarZaDar” – Advantages and Disadvantages</i>	53
O-30	Lidija VARGA-DEFTERDAROVIĆ IUPAC, periodni sustav elemenata i STRUNA – hrvatsko kemijsko imenje i nazivlje <i>IUPAC, the periodic table of elements and STRUNA – Croatian chemical nomenclature and terminology</i>	54
	POSTERSKA PRIOPĆENJA / POSTER PRESENTATIONS	55
	KEMIJA / CHEMISTRY	
P-A1	Adriana KENDEL, Francesco Papi, Marina Ratkaj, Ivo Piantanida, Snežana Miljanić Istraživanje hibridnih struktura G-kvadrupleksa spektroskopijom površinski pojačanog Ramanova raspršenja <i>Study of hybrid G-quadruplex structures by surface-enhanced Raman scattering spectroscopy</i>	56
P-A2	Akmaral KUSSAYEVA, Zoran Glasovac, Davor Margetić Studij Diels-Alderove cikloadicije vinil karbodiimida s N-alkil iminima teorijom funkcionala gustoće <i>Density functional theory study of Diels-Alder cycloadditions of vinyl carbodiimides with N-alkyl imines</i>	57
P-A3	Gabriela Ravnjak, Andrea Dandić, Mateja Budetić, Mirela Samardžić, Aleksandar SEČENJI Kovalentna modifikacija MWCNT kvarternim amonijevim skupinama <i>Covalent modification of MWCNT with quaternary ammonium groups</i>	58
P-A4	Zrinka Duvnjak, Ivan Džajić, Alen Bjelopetrović, Marina Juribašić Kulcsar, Manda Ćurić, Ana BUDIMIR Utjecaj temperature na reakcije diciklopaladacije 4-dimetilaminoazobenzena <i>Effect of temperature on dicyclopalladation of 4-dimethylaminoazobenzenes</i>	59
P-A5	Alen BJELOPETROVIĆ, Darko Babić, Marko Robić, Marina Juribašić-Kulcsár, Manda Ćurić Mehanokemijska sinteza organopaladijevih spojeva izmjenom anionskih liganada u jednom koraku <i>One-step mechanosynthesis of organopalladium compounds via anion replacement</i>	60
P-A6	Alma RAMIĆ, Ana Matošević, Anita Bosak, Zrinka Kovarik, Tomica Hrenar, Ines Primožič Dizajn, sinteza i svojstva karbamata Cinchona alkaloida <i>Design, synthesis and characterisation of Cinchona alkaloid carbamates</i>	61
P-A7	Anđela BULJAN, Irena Dokli, Marin Roje Mikrovalna sinteza 2(1H)-kinolona nasuprot klasičnoj sintezi <i>Microwave-assisted synthesis of 2(1H)-quinolone vs. conventional synthesis</i>	62
P-A8	Ana AMIĆ, Zoran Marković, Dejan Milenković Termodinamička studija potencijala hvatanja slobodnih radikala fenoksilnim radikalom ferulinske kiseline <i>Free radical scavenging potency of ferulic acid phenoxyl radical – a thermodynamic study</i>	63
P-A9	Ana RATKOVIĆ, Irena Škorić Buchwald-Hartwigova aminacija klorom supstituiranog benzobicyklo[3.2.1] oktadienskog skeleta <i>Buchwald-Hartwig amination of the chloro substituted benzobicyclo[3.2.1] octadiene skeleton</i>	64
P-A10	Anamarija BRIŠ, Zoran Glasovac, Davor Margetić DFT-studij bazičnosti cikličkih derivata gvanidina u plinskoj fazi <i>Gas phase basicity of cyclic guanidine derivatives – a DFT study</i>	65
P-A11	Ankica SEKOVANIĆ, Tatjana Orct, Jasna Jurasović, Martina Piasek, Antonija Sulimanec Grgec, Anja Bošnjaković, Marijana Matek Sarić Konzentracije žive u uzorcima majčine krvi i kose, posteljici i krvi iz pupčane vrpce u povezanosti s konzumacijom hrane morskoga podrijetla <i>Concentrations of mercury in the samples of maternal blood and hair, placenta and umbilical cord blood associated with the seafood consumption</i>	66
P-A12	Jasna Halambek, Antonela NINČEVIĆ GRASSINO Primjena pektina izoliranog iz otpada kore rajčice kao ekološki prihvatljivog inhibitora korozije kositra <i>Utilisation of pectin isolated from tomato peel waste as an eco-friendly tin corrosion inhibitor</i>	67

P-A13	Azra ĐULOVIĆ, Marijana Popović, Franko Burčul, Ivica Blažević Stabilnost izotiocijanata u uvjetima koje oponašaju hidrodestilaciju i mikrovalovima potpomognutu destilaciju <i>Stability of isothiocyanates in conditions mimicking hydrodistillation and microwave-assisted distillation</i>	68
P-A14	Biserka PRUGOVEČKI, Darko Vušak, Dubravka Matković-Čalogović Sinteza i karakterizacija bakrovih(II) kompleksa s glicinom i heterocikličkim bazama <i>Synthesis and characterization of copper(II) complexes with glycine and heterocyclic bases</i>	69
P-A15	Branimir BERTOŠA, Tadija Kekić Simulacije molekulske dinamike interakcije između FNR i TROL proteina uključениh u zadnji korak fotosinteze <i>Molecular dynamics simulations of interaction between FNR and TROL proteins included in final step of photosynthetic electron transfer</i>	70
P-A16	Dajana BARIŠIĆ, Ana Budimir, Manda Ćurić, Marina Juribašić Kulcsar Termodinamika nastajanja kompleksa diciklopaladiranog 4-dimetilaminoazobenzena s dušikovim ligandima u otopini <i>Thermodynamics of complexes formation of dicyclopalladated 4-dimethylaminoazobenzene with nitrogen ligands in solution</i>	71
P-A17	Damir PAVLIČEK, Marija Denžić Lugomer Razvoj i validacija LC-MS/MS metode za simultano određivanje benzimidazola i levamisola u mlijeku <i>Development and validation of a LC-MS/MS method for the simultaneous determination of benzimidazoles and levamisole in milk</i>	72
P-A18	Danijel NAMJESNIK, Marija Leko, Ela Radošević, Tajana Preočanin Utjecaj iona na površinska svojstva kvarca <i>Influence of ions on surface properties of quartz</i>	73
P-A19	Danijela CVIJANOVIĆ, Mirna Mandarić, Biserka Prugovečki, Jasna Lovrić, Marina Cindrić, Višnja Vrdoljak Sinteza, karakterizacija i citotoksičnost dioksomolibdenovih(VI) kompleksa s 4-metoksisalicilaldehid-izonikotinoil-hidrazonom <i>Synthesis, characterization and cytotoxicity of dioxomolybdenum(VI) complexes with 4-methoxysalicylaldehyde isonicotinoyl hydrazone</i>	74
P-A20	Dario Klarić, Petar BIBULIĆ, Želimir Jelčić, Helena Cerić Primjena FT4 reometra u karakterizaciji farmaceutskih praškastih materijala <i>Application of FT4 rheometer in the characterisation of pharmaceutical powder material</i>	75
P-A21	Tin Klačić, Bartol Božić, Davor KOVAČEVIĆ PAH/PAA polielektrolitni višeslojevi na površini silicijeva dioksida <i>PAH/PAA polyelectrolyte multilayers on silica surface</i>	76
P-A22	Dino KUZMAN, Višnja Vrdoljak, Vladimir Stilinoić, Marina Cindrić Molekulska i kristalna struktura polioksomolibdata građenih od $[Mo_7O_{24}]^{6-}$ i $[CoMo_6(OH)_6O_{18}]^{6-}$ aniona <i>Molecular and crystal structure of polyoxomolybdates built from $[Mo_7O_{24}]^{6-}$ i $[CoMo_6(OH)_6O_{18}]^{6-}$ anions</i>	77
P-A23	Dragana MUTAVDŽIĆ PAVLOVIĆ, Kristina Tolić, Ivan Lukač, Helena Prskalo, Mislav Runje Određivanje sorpcijskih parametara memantina u uzorcima tla i sedimenta s teritorija Republike Hrvatske <i>Determination of memantine sorption parameters in Croatian soil and sediment samples</i>	78
P-A24	Ema HORAK, Robert Vianello, Nataša Perin, Marijana Hranjec, Kristina Bobanović, Ivana Murković Steinberg Određivanje žive(II) indikatorskim trakicama temeljenim na fluorescentnim derivatima benzimidazola <i>Test strips for mercury(II) detection based on fluorescent benzimidazole derivatives as optical transducers</i>	79
P-A25	Franciska GRGIĆ, Hana Rimanić, Marijana Pocrnić, Darko Kontrec, Ana Budimir, Nives Galić Kompleksiranje lantanoida aroilhidrazonima izvedenim iz nikotinohidrazida: spektrofotometrijsko određivanje <i>Complexation of lanthanides by aroylhydrazones derived from nicotinic acid hydrazide: spectrophotometric determination</i>	80
P-A26	Giovanna SPERANZA, Kalliopi Avramidou, Giuseppe Cappelletti, Denise Cavuoto, Carlo F. Morelli, Davide Rosa, Sara Sangiorgio, Teodora Bavaro, Giorgio Marrubini, Daniela Ubiali Lipazama katalizirana sinteza estera masnih kiselina: istraživanje uvjeta reakcije primjenom DoE pristupa <i>Lipase-catalyzed synthesis of sugar fatty acid esters: study of the reaction conditions through a DoE-approach</i>	81

P-A27	Gordan HORVAT, Siniša Tarana, Nikolina Vidović, Nikola Cindro, Giovanna Speranza, Vladislav Tomišić Kompleksiranje homociklopeptida s halogenidima i oksoanionima u acetonitrilu i dimetilsulfoksidu <i>Complexation of homocyclopeptides with halides and oxoanions in acetonitrile and dimethyl sulfoxide</i>	82
P-A28	Igor ŽIVKOVIĆ, Ita Gruić-Sovulj Kako hidrofobnost utječe na diskriminaciju izoleucil-tRNA-sintetaze prema aminokiselinama? <i>How hydrophobicity modulates amino acid discrimination by isoleucyl-tRNA synthetase?</i>	83
P-A29	Igor PICEK, Blaženka Foretić, Ivana Furač, Dubravka Matković-Čalogović Supramolekulski kompleksi između bis-piridinij-4-oksima i različitih cijanoferat-platfomi <i>The supramolecular complexes between bis-pyridinium-4-oxime and distinctive cyanoiron platforms</i>	84
P-A30	Ines PRIMOŽIČ, Karlo Sović, Tomica Hrenar Poboljšanje aktivnosti kinuklidinskih spojeva temeljeno na multivariatnoj analizi podataka <i>Activity improvements of quinuclidinium compounds based on multivariate data analysis</i>	85
P-A31	Irena IVANIŠEVIĆ, Petar Kassal, Andrea Milinković, Anamarija Rogina, Stjepan Milardović Termalno sinteriranje vodljive tinte temeljene na nanočesticama srebra otisnute na fleksibilnoj podlozi <i>Sintering of silver nanoink deposited on flexible substrate by conventional thermal method</i>	86
P-A32	Irena RADIĆ, Zlata Lasić, Davor Šestan, Nives Galić Razvoj metode tekućinske kromatografije ultravisoke djelotvornosti za analizu razgradnih produkata lijeka dasatiniba <i>Development of ultra performance liquid chromatographic method for the analysis of Dasatinib degradation products</i>	87
P-A3	Iva HABINOVEC, Noelle Benčić, Mirjana Bukvić, Ivan Grgičević, Ivana Mikulandra, Tomislav Jednačak, Predrag Novak Analiza makrozona, novih bioaktivnih konjugata azitromicina, tehnikom LC-SPE/NMR <i>LC-SPE/NMR analysis of macrozones, new bioactive azithromycin conjugates</i>	88
P-A34	Iva OREHOVEC, Danijel Glavač, Irena Dokli, Matija Greadičak, Ivo Piantanida Utjecaj supramolekulske organizacije konjugata piren-kinolina na njihovu interakciju s DNA <i>Impact of the supramolecular organisation of pyrene-quinoline conjugates on their interaction with ds-DNA</i>	89
P-A35	Ivana ŠKUGOR RONČEVIĆ, Nives Vladislavić, Ana Boban, Ljubica Bosnić, Marijo Buzuk, Maša Buljac Primjena modificirane ugljikove elektrode za voltametrijsko određivanje teških metala u medu <i>Application of modified carbon electrode for voltammetric determination of heavy metals in honey</i>	90
P-A36	Mateo Glumac, Zvonimir Jažo, Josip Radić, Glorija GRANIĆ, Franka FOLO, Ivana DRVENTIĆ <i>Salvia officinalis</i> L. – mala tvornica spojeva. Varijacije među jedinkama <i>Salvia officinalis</i> L. – a small factory of compounds. Variations among individuals	91
P-A37	Ivana KOVAČIĆ, Katarina Vazdar, Ivanka Jerić Priprava C-glikozil aminokiselina post-kondenzacijskom modifikacijom Passerinijevih produkata <i>Synthesis of C-glycosyl amino acids by post-condensation modification of Passerini products</i>	92
P-A38	Ivana MIKULANDRA, Matea Facković, Anamarija Lulić, Iva Habinovec, Noelle Benčić, Mirjana Bukvić Krajačić, Ivan Grgičević, Tomislav Jednačak, Marina Cindrić, Predrag Novak Priprava i karakterizacija makrozona, novih bioaktivnih konjugata azitromicina <i>Synthesis and characterization of macrozones, new bioactive azithromycin conjugates</i>	93
P-A39	Ivana NIKŠIĆ-FRANJIĆ, Igor Sviben, Marija Bonifačić, Ivan Ljubić Računalno i eksperimentalno istraživanje reakcija vodikova atoma s halogeniranim organskim molekulama u vodenim otopinama <i>Computational and experimental study of hydrogen atom reactions with halogenated organic molecules in aqueous solutions</i>	94
P-A40	Ivana PANŽIĆ, Vedran Kojić, Jimmy Mangalam, Thomas Rath, Vilko Mandić, Krunoslav Juraić, Gregor Trimmel, Andreja Gajović Nanostrukturirani cinkov oksid kao sloj za vođenje elektrona u perovskitnim solarnim ćelijama <i>Nanostructured zinc oxide as electron transport layer in perovskite solar cells</i>	95
P-A41	Ivana SOKOL, Nikolina Kalčec, Mia Krnić, Nataša Perin, Sandra Liekens, Silvana Raić-Malić, Tatjana Gazivoda Kraljević Sinteza i citostatska aktivnost novih 1,2,3-triazolilnih derivata kumarina i iminokumarina <i>Synthesis and cytostatic activity of novel 1,2,3-triazolyl-tagged coumarin and iminocoumarin derivatives</i>	96
P-A42	Jasmina LAPIĆ, Mateja Toma, Davor Šakić, Valerije Vrček, Senka Djaković Ferocenoiliranje uracila i njegovih derivata <i>Ferrocenylation of uracil and its derivatives</i>	97

P-A43	Jelena Bijelić, Anamarija Stanković, Elvira Kovač-Andrić, Berislav Marković, Mirjana Bijelić, Jasminka Popović, Željko Skoko, Goran Štefanić, Zvonko Jagličić, Pascal Cop, Bernd Smarsly, Georg Garnweitner, Igor DJERDJ Istraživanje nanokristalnih trostrukih perovskita na bazi volframa i telurija <i>Investigation of nanocrystalline tungsten- and tellurium-based triple perovskites</i>	98
P-A44	Jelena PARLOV VUKOVIĆ, Bruno Pinević, Ljiljana Marinić Pajc, Lucija Konjević, Nada Uzorinac Nasipak, Tomislav Jednačak, Predrag Novak Usporedba strukturnih parametara i parametara stabilnosti sirovih nafte i njihovih teških frakcija <i>Correlations between structural and stability parameters of crude oils and their heavy fractions</i>	99
P-A45	Jolita KUGINYTĚ, Greta Ragaitė, Miglė Dagilienė, Vaida Milišūnaitė, Gita Matulevičiūtė, Frank A. Slok, Algirdas Šačkus Priprava metil-5-cikloaminil-1,2-oksazol-4-karboksilata <i>Synthesis of methyl 5-cycloaminyl-1,2-oxazole-4-carboxylates</i>	100
P-A46	Josip RADIĆ, Ivana Munitić, Irena Budić-Leto, Marija Bralić Potenciometrijsko određivanje fluorida u vinima s područja Dalmacije i statistička analiza <i>Potentiometric determination of fluoride in wines of Dalmatia area and statistical analysis</i>	101
P-A47	Jasmina Salopek, Davor Kovačević, Tomislav Kremer, Nikola Cindro, Josip POŽAR Interpolielektrolitna neutralizacija u otopinama i na električki nabijenim površinama <i>Interpolyelectrolyte neutralization in solutions and at electrically charged surfaces</i>	102
P-A48	Karolina KĘDRA-KRÓLIK, Izabela Chmielewska, Anna Michnik, Piotr Zarzycki Mutacije onkogeno raka pluća i njihov odraz u termalno potaknutoj denaturaciji proteina u krvnom serumu <i>Lung cancer oncogene mutations reflection in thermally induced blood serum proteins denaturation</i>	103
P-A49	Katarina LEKO, Andrea USENIK, Nikola Cindro, Matija Modrušan, Vladislav Tomišić Kompleksacijska svojstva fenantridinskih derivata kaliks[4]arena <i>Complexation properties of phenantridine-based calix[4]arene derivatives</i>	104
P-A50	Katarina ZLATIĆ, Ivana Antol, Nikola Basarić Fotofizička svojstva i fotokemijska reaktivnost prekursora kinon-metida koji sadrže BODIPY kromofor <i>Photophysical properties and photochemical reactivity of a quinone methide precursor containing BODIPY chromophore</i>	105
P-A51	Kristina TOLIĆ, Dragana Mutavdžić Pavlović, Mislav Runje Razvoj i validacija stabilitetno indikativne UHPLC metode za određivanje krizotiniba i njegovih razgradnih produkata <i>Development and validation of stability indicative UHPLC method for determination of Crizotinib and its degradation products</i>	106
P-A52	Lara ŠTAJNER, Lorena Kordić, Sanja Matečić Mušanić Primjena metoda termičke analize pri praćenju udjela amorfne faze i kompatibilnosti <i>Application of thermal analysis as screening tool for monitoring of amorphous phase content and compatibility study</i>	107
P-A53	Leo ŠTEFAN, Dubravka Matković-Čalogović, Miljenko Dumić 1,2-bis[(1-metil-1H-imidazol-2-il)tio]etan: sinteza, karakterizacija i transformacija u čvrstom stanju <i>1,2-bis[(1-methyl-1H-imidazol-2-yl)thio]ethane: synthesis, characterisation and solid state transformation</i>	108
P-A54	Lidija BRKLJAČIĆ, Ivanka Jerić Hidrazino-derivat glutaminske kiseline za derivatizaciju karbonilnih spojeva <i>Glutamic acid-derived hydrazine reagent for derivatization of carbonyl compounds</i>	109
P-A55	Lidija VARGA-DEFTERDAROVIĆ, Marijana Vinković, Ivanka Jerić Tijek i produkti višekomponentnih reakcija temeljenih na izocijanidima s nezaštićenim ugljikohidratima <i>The course and the products of the isocyanide-based multicomponent reactions with unprotected carbohydrates</i>	110
P-A56	Linda BAZINA, Ana Maravić, Ines Primožič, Matilda Šprung, Renata Odžak Sinteza i antimikrobna aktivnost dvostrukih kvarternih amonijevih soli čija je okosnica 3-kinuklidinol <i>Synthesis and antimicrobial potential of bisquaternary ammonium compounds based on quinuclidine-3-ol</i>	111
P-A57	Livia KURAJICA, Magdalena Ujević Bošnjak, Jurica Štiglić Određivanje haloocetnih kiselina u vodi za piće u Hrvatskoj <i>Determination of haloacetic acid in drinking water in Croatia</i>	112

P-A58	Lucija PTIČEK, Marija Mudrešić, Petra Grbčić, Sandra Kraljević Pavelić, Livio Racané Sinteza i antiproliferativna aktivnost novih amidino-supstituiranih arilnih bisbenzotiazola <i>Synthesis and anti-proliferative activity of novel amidino-substituted aryl-bisbenzothiazoles</i>	113
P-A59	Luka KRSTULOVIĆ, Marijana Jukić, Teuta Opačak-Bernardi, Kristina Starčević, Miroslav Bajić, Ljubica Glavaš-Obrovac Protutumorska aktivnost novih benzimidazolnih amidinskih derivata 7-klor-4-aminokinolina <i>Antitumor activity of novel benzimidazole amidine derivatives of 7-chloro-4-aminoquinoline</i>	114
P-A60	Maja BIOČIĆ, Lea Kukoč Modun, Martina Stipišić, Njgomir Radić Kinetičko spektrofotometrijsko određivanje <i>N</i> -acetil-L-cisteina temeljeno na redukciji kompleksa bakra(II) i batokuproin disulfonata <i>Kinetic spectrophotometric determination of N-acetyl-L-cysteine based on the reduction of copper(II)-bathocuproine disulphonate complex</i>	115
P-A61	Maja CINDRIĆ, Livio Racané, Nataša Perin, Ida Boček, Anja Beč, Ivo Zlatar, Karmen Brajša, Marijana Hranjec Antiproliferativna aktivnost amidino supstituiranih benzimidazola i benzotiazola ispitana na 2D i 3D staničnim linijama <i>Antiproliferative activity of amidino substituted benzimidazoles and benzothiazoles explored by 2D and 3D cell culture system</i>	116
P-A62	Marijana HRANJEC, Nataša Perin, Ema Horak, Ivana Murković Steinberg, Darko Babić, Robert Vianello Spektroskopske karakteristike i imobilizacija fluorescentnih amino supstituiranih benzimidazo[1,2- <i>a</i>]kinolina <i>Spectroscopic properties and immobilisation of fluorescent amino substituted benzimidazo[1,2-a]quinolines</i>	117
P-A63	Marina TAŠNER, Draginja Mrvoš-Sermek, Dubravka Matković-Čalogović Kompleks bakra(II) s karnozinom <i>Copper(II) complex with carnosine</i>	118
P-A64	Mario CETINA, Dajana Gašo Sokač, Valentina Bušić Supramolekulska struktura novog fenaciloksimskog derivata piridoksal oksima <i>Supramolecular structure of new phenacyloxime derivative of piridoxal oxime</i>	119
P-A65	Mario KOMAR, Melita Lončarić, Maja Molnar Sinteza kumarinskih derivata 1,2,4-triazola u eutektičnim otapalima <i>Synthesis of coumarinyl 1,2,4-triazoles in deep eutectic solvents</i>	120
P-A66	Mario PIPUNIĆ, Ivan Pucko, Lucija Rebrović, Lucija Kurte, Fabio Faraguna, Ante Jukić Utjecaj butanola na svojstva mješavina obnovljivog i mineralnog dizelskog goriva <i>Influence of butanol on renewable and mineral diesel fuel mixture properties</i>	121
P-A67	Marko VISKIĆ, Njara Rakotomanomana, Farid Chemat, Marko Vinceković, Anet Režek-Jambrak Procjena topljivosti bioaktivnih spojeva mediteranskog bilja u "zelenim" otapalima i prirodnim niskotemperaturnim eutektičnim otapalima softverom COSMO-RS <i>Estimation of solubility of bioactive compounds from Mediterranean plants in "green" solvents and natural deep eutectic solvents by COSMO-RS software</i>	122
P-A68	Martina JAKOVLJEVIĆ, Jelena Vladić, Maja Molnar, Stela Jokić Ekstrakcija rutina i ružmarinske kiseline iz iz primorskog vriska (<i>Satureja montana</i> L.) primjenom eutektičnih otapala <i>Extraction of rutin and rosmarinic acid from Satureja montana L. with deep eutectic solvents</i>	123
P-A69	Martina MUŠKOVIĆ, Nela Malatesti Fotofizikalna i fotokemijska svojstva slobodne baze i Zn(II) kompleksa <i>N</i> -metiliranih tetra- i tripiridilporfirina <i>Photophysical and photochemical characteristics of free-base and Zn(II) complexes of N-methylated tetra- and tripyridylporphyrins</i>	124
P-A70	Marzena PRUS, Karolina Szymanek, Jennifer Mills, Laura Nielsen Lammers, Wojciech Piasecki, Karolina Kedra-Królik, Piotr Zarzycki Vremenski razlučena elektrokinetička studija početnog stvaranja taloga kalcijeva karbonata <i>Time-resolved electrokinetics study of nascent calcium carbonate precipitate</i>	125
P-A71	Matea VITKOVIĆ, Vladimir Stilinović, Dominik Cinčić Kompetitivno nastajanje kokristala temeljenih na halogenskoj ili vodikovoj vezi u mehanokemijskim reakcijama potpomognutima kapljevnom <i>Competitive formation of halogen and hydrogen-bonded cocrystals by liquid-assisted grinding</i>	126

P-A72	Mateja TOMA, Lucija Božičević, Jasmina Lapić, Senka Djaković, Davor Šakić, Valerije Vrček NMR i kvantno-kemijska studija N7/N9 transaciliranja ferocenoil-purina <i>NMR and computational study of N7/N9 transacylation in ferrocenoyl-purines</i>	127
P-A73	Mia ANTOLČIĆ, Mislav Runje, Nives Galić, Vedrana Jurković Razvoj i validacija UPLC-MS/MS metode za određivanje genotoksičnih onečišćenja u ceritinibu <i>Development and validation of UPLC-MS/MS method for the determination of genotoxic impurities in Ceritinib active pharmaceutical ingredient</i>	128
P-A74	Mihaela TUKSAR, Moris Mihovilović, Ivica Grebenar, Dražen Čavužić Razvoj procesa kontinuirane kristalizacije upotrebom jednostupanjskog kristalizatora s miješanjem suspenzije i uklanjanjem nastalog proizvoda <i>Development of continuous crystallization process using single stage mixed-suspension, mixed product removal crystallizer (MSMPR)</i>	129
P-A75	Mirela MATIĆ, Bernard Denegri Intrinsični elektronski efekti u organofosfatnim izlaznim skupinama <i>Intrinsic electronic effects in organophosphate leaving groups</i>	130
P-A76	Mirha PAZALJA, Mirsada Salihović Kompleksiranje talija krunastim eterima <i>Complexing of thallium with crown ethers</i>	131
P-A77	Mladenka JURIN, Darko Kontrec, Marin Roje Sinteza (\pm)-trans-3-amino- β -laktama i njegova enantioseparacija na novoj polisaharidnoj kiralnoj stacionarnoj fazi HPLC-om i SFC-om <i>Synthesis of (\pm)-trans-3-amino-β-lactam and its enantioseparation on the new polysaccharide-based chiral stationary phase by HPLC and SFC</i>	132
P-A78	Monika KOVAČEVIĆ, Iva Dorić, Mojca Čakić Semenčić, Ivan Kodrin, Valentina Milašinović, Lidija Barišić Sinteza i konformacijska analiza konjugata ferocen-1,1'-diamina i valina <i>Synthesis and conformational analysis of the conjugate of ferrocene-1,1'-diamine and valine</i>	133
P-A79	Natalija PANTALON JURAJ, Tiana Novosel, Marko Krklec, Berislav Perić, Robert Vianello, Silvana Raić-Malić, Srećko I. Kirin Sinteza i karakterizacija 1,2,3-triazolnih liganada i njihovih kompleksa s prijelaznim metalima <i>Synthesis and characterization of 1,2,3-triazole ligands and their transition metal complexes</i>	134
P-A80	Magdalena Vincetić, Nela MALATESTI Reakcija 1,3-dipolarne cikloadicije 5,10,15,20-tetra(3-piridil)porfirina s azometinskim ilidom <i>1,3-Dipolar cycloaddition reaction of 5,10,15,20-tetra(3-pyridyl)porphyrin with azomethine ylide</i>	135
P-A81	Nikola CINDRO, Dajana Barišić, Nikola Bregović, Krunoslav Užarević, Vladislav Tomišić Sinteza i fotokemijska svojstva anionskog receptora s azokarboksamidnim skupinama <i>Synthesis and photochemical properties of anion receptor containing azocarboxamide groups</i>	136
P-A82	Nikolina FILIPOVIĆ, Jelena Brdarić, Berislav Marković, Natalija Šantić, Dalibor Tatar Adsorpcija poli(akrilne kiseline) na aluminijevu oksidu i silicijevu karbidu <i>Adsorption of polyacrylic acid onto aluminum oxide and silicon carbide</i>	137
P-A83	Nikolina VIDOVIĆ, Kalliopi Avramidou, Ermelinda Falletta, Teresa Recca, Giorgio Marrubini, Riccardo Semproli, Diego Bosco, Filippo Fiorentini, Silvia Rapacioli, Daniela Ubiali, Giovanna Speranza Biokataliza, cirkularna ekonomija i kozmetika: BIOCOSM projekt <i>Biocatalysis, circular economy and cosmetics: the BIOCOSM project</i>	138
P-A84	Nives GALIĆ, Marijana Pocrnić, Darko Kontrec Kompleksiranje lantanoida aroilhidrazonima izvedenim iz nikotinohidrazida: određivanje spektrometrijom masa <i>Complexation of lanthanides by aroylhydrazones derived from nicotinic acid hydrazide: mass spectrometric determination</i>	139
P-A85	Robin S. STEIN, Catherine King, Igor Huskić, Julia L. Shamshina, Hatem Titi, Tomislav Friščić, Robin D. Rogers Uporaba nuklearne magnetske rezonancije u karakterizaciji organskih i metal-organskih sustava <i>The use of solid-state NMR spectroscopy in organic and metal-organic systems</i>	140
P-A86	Sandra JURIĆ, Marijan Marijan, Olga Kronja Utjecaj duljine lanca na nukleofugalnost alifatskih karboksilata <i>Influence of chain length on the nucleofugality of aliphatic carboxylates</i>	141
P-A87	Sanja ŠKULJ, Zlatko Brkljača, Mario Vazdar Prijenos protona kroz unutarnju mitohondrijsku membranu pomoću UCP2 proteina <i>Proton transport across inner mitochondrial membrane assisted with UCP2 protein</i>	142

P-A88	Sara MATIĆ, Mihaela Matovina, Filip Šupljika, Ivo Crnolatac, Sanja Tomić Karakterizacija interakcija DPP III s domenom Kelch proteina Keap1 <i>Characterization of DPP III interactions with Keap1 Kelch domain</i>	143
P-A89	Mario CETINA, Silvija Maračić, Jasmina Lapić, Senka Djaković, Silvana Raić-Malić Konformacija i samoudruživanje konjugata kinolina i ferocena <i>Conformation and self assembling of quinoline-ferrocene conjugates</i>	144
P-A90	Andrea BISTROVIĆ, Ivana Stolić, Luka Krstulović, Martin C. Taylor, John M. Kelly, Sanja Tomić, Miroslav Bajić, Silvana RAIĆ-MALIĆ Novi simetrični bis-benzimidazoli: sinteza, DNA/RNA vezivanje i antitripanosomska aktivnost <i>Novel symmetric bis-benzimidazoles: synthesis, DNA/RNA binding and antitrypanosomal activit</i>	145
P-A91	Kristina Bobanović, Ivana Steinberg, Svjetlana KRIŠTAFOR 1,2,3-triazoli-benzimidazoli i bis-(1,2,3-triazolil-benzimidazolil)benzeni: sinteza i optička senzorska svojstva <i>Benzimidazole-1,2,3-triazole derivatives and bis-(1,2,3-triazolyl benzimidazolyl) benzenes: synthesis and chemosensing properties</i>	146
P-A92	Zvonimir Marijanović, Ivana Kulušić, Marko Šuste, Mladenka Šarolić, Žana Delić, Tomislav SVALINA Hlapljivi spojevi u rakiji od dunje (<i>Cydonia oblonga</i> Mill.) <i>Volatile compounds in quinces-brandy (Cydonia oblonga Mill.)</i>	147
P-A93	Tomislav GREGORIĆ, Janja Makarević, Leo Frkanec Novi fumaramidni gelatori i njihov prijepis u polimere <i>New fumaramide gelators and their transcription in polymers</i>	148
P-A94	Valentina PETRUŠEVSKA, Sandro Makarić, Gordan Dinter, Ana Mornar Važnost odabira prikladnog otapala za stabilnost otopine uzorka na primjeru DMSO-a <i>The importance of diluent choice for sample solution stability: The DMSO case study</i>	149
P-A95	Veronika KOVAČ, Tea Lukačević Ferocenski ASIMETRIČNI kurkuminoid-pirazoli – novi potencijalno biološki aktivni spojevi <i>Ferrocene-containing asymmetric curcuminoid pyrazoles – new potentially biologically active compounds</i>	150
P-A96	Vesna PETROVIĆ PEROKOVIĆ, Željka Car, Andrea Usenik, Teuta Opačak-Bernardi, Andrea Jurić, Srđanka Tomić Sinteza i antiproliferativni učinak adamantilnih derivata kojične kiseline <i>Synthesis and antiproliferative activity of adamantyl kojic acid derivatives</i>	151
P-A97	Vesna RASTIJA, Maja Molnar, Harshad Brahmabhatt Istraživanje nove serije pirazolina kao potencijalnih inhibitora fosfodiesteraze tipa 5 (PDE5) metodom molekularnog uklapanja <i>Molecular docking study of a novel series of pyrazolines as potential inhibitors of phosphodiesterase type 5 (PDE5)</i>	152
P-A98	Viktor BOJOVIĆ, Jadranko Batista, Ana Amić, Bono Lučić Izračun razine nasumične korelacije molekularnih deskriptora u modeliranju odnosa između strukture i svojstva <i>Estimation of the random correlation level of molecular descriptors in structure-property modeling</i>	153
P-A99	Vinko NEMEC, Dominik Cinčić Mogućnost nastajanja halogenske veze s kisikovim atomom morfolinskog fragmenta u građevnim blokovima kokristala <i>Halogen bonding proclivity of the morpholinyl fragment oxygen atom in cocrystal building blocks</i>	154
P-A100	Vitomir VUŠAK, Ernest Meštović Utjecaj srodnih spojeva na kristalne forme entakapona <i>Influence of structurally similar compounds on crystal forms of Entacapone</i>	155
P-A101	Vladimir DAMJANOVIĆ, Danijela Cvijanović, Jasna Lovrić, Blaženka Foretić Sinteza i karakterizacija odabranih <i>N,N'</i> -supstituiranih bis(piridinijevih aldoksima) i njihovih pentacijano(piridinij-aldoksim)ferat(II)-kompleksa <i>Synthesis and characterization of selected <i>N,N'</i>-substituted bis(pyridinium aldoximes) and their pentacyano(pyridinium aldoxime)ferrate(II) complexes</i>	156

P-A102	Gordan HORVAT, Antun Barišić, Tamara Rinkovec, Nikola Cindro, Leo Frkanec, Vladislav Tomišić Termodinamičko i strukturno istraživanje kompleksiranja kalijevih kationa s amidnim derivatima kaliks[4]arena u nekoliko organskih otapala <i>Thermodynamic and structural studies of the complexation of alkali-metal cations with calix[4]arene amide derivatives in several organic solvents</i>	157
P-A10	Željka SOLDIN, Dijana Kos, Boris-Marko Kukovec, Marijana Đaković Reakcije heksafluoroacetilacetonatnih kompleksa bakra(II) i nikla(II) s amidnim derivatima piridina: sinteza i karakterizacija. <i>Reactions of copper(II) and nickel(II) hexafluoroacetylacetonates with pyridine-based amides: synthesis and characterization.</i>	158
P-A104	Zlata LASIĆ, Irena Radić, Luka Jerić, Nives Galić Razvoj metode tekućinske kromatografije ultravisoke djelotvornosti za analizu razgradnih produkata lijeka elvitegravira <i>Development of ultra-high performance liquid chromatographic method for the analysis of Elvitegravir degradation products</i>	159
P-A105	Zrinka MASTELIĆ SAMARDŽIĆ, Moris Mihovilović, Ozren Wittine, Aida Omerbašić, Vitomir Vušak Primjena protočne kemije u razvoju procesa sinteze aktivnih farmaceutskih supstancija <i>Application of flow chemistry in process development of active pharmaceutical ingredients (APIs)</i>	160
P-A106	Zvonimir JAŽO, Mateo Glumac, Josip Radić Analitičko istraživanje tla na području Dalmacije <i>Analytical study of soils in Dalmatia</i>	161
P-A107	Anamarija Stanković, Silvija Šafranko, Jasminka Kontrec, Branka Njegić Džakula, Daniel Mark Lyons, Berislav MARKOVIĆ, Damir Kralj Istraživanje morfoloških karakteristika kalcijeva oksalata monohidrata: formiranje kristala u sustavima različite kemijske kompleksnosti <i>Investigating the morphological properties of calcium oxalate monohydrate: crystal formation in systems with different chemical complexity</i>	162
P-A108	Maja ANIČIĆ, Mateja Budetić, Mirela SAMARDŽIĆ Primjena tenzidnog senzora pri optimiranju sastava formulacije oplemenjivača rublja <i>The application of surfactant sensor in optimization of composition of fabric softeners formulation</i>	163
P-A109	Marina POLJAK, Adriana Kenđel, Ines Primožič, Snežana Miljanić, Tomica Hrenar Spektroskopsko i kemometričko istraživanje mirisnih spojeva <i>Spectroscopic and chemometric investigation of odorants</i>	164
P-A110	Martina Andrijević, Andrea DANDIĆ, Mateja Budetić, Mirela Samardžić, Aleksandar Sečenji Sinteza i karakterizacija novog fluorescentnog indikatora za detekciju selenija <i>Synthesis and characterization of new fluorescent indicator for selenium detection</i>	165
P-A111	Irena G. STARÁ, Ivo Starý, Jiří Klívar, Michal Šámal, Lucie Bednárová Dijastereomerno i enantiomerno čisti helicenski 2,2'-bipiridini: novi tip kirooptičkih prekidača <i>Diastereo- and enantiopure helicene 2,2'-bipyridines: a new type of chiroptical switches</i>	166
	POSTERSKA PRIOPĆENJA / POSTER PRESENTATIONS	167
	KEMIJSKO I BIOKEMIJSKO INŽENJERSTVO / CHEMICAL AND BIOCHEMICAL ENGINEERING	
P-B1	Joško BARBARIĆ, Krunoslav Žižek Priprava i karakterizacija čvrstih disperzija lurasidon-hidroklorida <i>Preparation and characterization of lurasidone hydrochloride solid dispersions</i>	168
P-B2	Matija GRETIĆ, Gordana Matijašić, Mateja Štanfel, Nikola Rimac Priprava i <i>in vitro</i> karakterizacija farmaceutskih peleta <i>Preparation and in vitro characterization of pharmaceutical pellets</i>	169
P-B3	Ana PETRAČIĆ, Aleksandra Sander, Matija Cvetnić Ekstrakcija metala, bora i fosfora iz otpadne životinjske masti pomoću niskotemperaturnih eutektičnih otapala <i>Extraction of metals, boron and phosphorus from waste animal fat using deep eutectic solvents</i>	170
P-B4	Krunoslav ŽIŽEK, Iva Gavran, Joško Barbarić Priprava i karakterizacija minitableta za oralnu primjenu lurasidon-hidroklorida <i>Preparation and characterization of mini-tabs for oral delivery of lurasidone hydrochloride</i>	171

P-B5	Anamarija Mitar, Marija Lukić, Jasna PRLIĆ KARDUM Kontinuirana kapljevinska ekstrakcija primjenom niskotemperaturnih eutektičnih otapala u milireaktoru <i>Continuous liquid-liquid extraction by deep eutectic solvents in a millireactor</i>	172
P-B6	Tomislav Domanovac, Dajana Kučić Grgić, Monika ŠABIĆ RUNJAVEC, Marija Vuković Domanovac Utjecaj temperature u razgradnji realnog uzorka biorazgradljive frakcije iz miješanog komunalnog otpada kompostiranjem <i>Effect of temperature in degradation of real sample of biodegradable fraction from mixed municipal waste during composting</i>	173
P-B7	Kristina ZAGAJSKI KUČAN, Marko Rogošić Odjeljivanje piridina i tiofena iz smjesa ugljikovodika primjenom DES-a na bazi kolin-klorida i propilen-glikola – istraživanje ravnoteže kapljevina-kapljevina <i>Pyridine and thiophene separation from hydrocarbon mixtures using DES based on choline chloride and propylene glycol – a LLE study</i>	174
P-B8	Miće JAKIĆ, Jelena Jakić, Iva Radonić, Martina Vidović Utjecaj dodatka Mg(OH) ₂ na toplinska svojstva poli(vinil-klorida) <i>Effect of Mg(OH)₂ addition on thermal properties of poly(vinyl chloride)</i>	175
P-B9	Veselin ILIEV, Dessislava Moutafchieva Numeričko istraživanje utjecaja položaja membrane na zadržavanje plina i brzinu smičnog naprezanja u koloni s mjehurićima i uronjenom membranom <i>Numerical investigation of the membrane position effect on gas holdup and shear strain rate in bubble column with immersed membrane</i>	176
P-B10	Davor Dolar, Klara Karadakić, Nina Čavarović, Marko Racar, Krešimir KOŠUTIĆ Oporaba komunalne otpadne vode za navodnjavanje s MBR i RO/NF procesima <i>Municipal wastewater reuse for irrigation by MBR and RO/NF processes</i>	177
P-B11	Igor NEŽIĆ, Aleksandra Sander, Ernest Meštrović Priprava i karakterizacija amorfne čvrste disperzije dobivene sušenjem raspršivanjem <i>Preparation and characterization of amorphous solid dispersion obtained via spray drying technology</i>	178
P-B12	Martin GOJUN, Anita Šalić, Bruno Zelić Optimizacija mikroreaktorskog sustava za provedbu enzimatske sinteze biodizela iz jestivog i otpadnog ulja <i>Optimization of microreactor system for enzymatic synthesis of biodiesel from edible and waste oil</i>	179
P-B13	Marina DUPLANČIĆ, Vesna Tomašić, Zoran Gomzi Uklanjanje hlapivih organskih spojeva u metalnim i keramičkim monolitnim reaktorima <i>Volatile organic compounds abatement in metal and ceramic monolith reactors</i>	180
P-B14	Vesna PEHAR, Davor Oršolić, Višnja Stepanić In silico analiza herbicida – utjecaj na ljudsko zdravlje <i>In silico analysis of herbicides – impact on human health</i>	181
P-B15	Biljana MILOVANOVIĆ, Đurđa Oljača, Stefan Pavlović, Gordana Ostojić, Zoran Obrenović Proizvodnja glinice iz pročišćene Bayerove otopine <i>Alumina production from purified Bayer liquor</i>	182
P-B16	Irena Krešić, Matko ERCEG Utjecaj organski modificiranih montmorilonita Cloisite 10A i Cloisite 30B na kristalnost i toplinska svojstva poli(etilen-oksida) <i>Effect of organically modified montmorillonite Cloisite 10A and Cloisite 30B on crystallinity and thermal properties of poly(ethylene oxide)</i>	183
P-B17	Ana-Marija CIKOŠ, Bojan Šarkanj, Igor Jerković, Marin Roje, Stela Jokić Antifungalna aktivnost ekstrakata odabranih morskih organizama <i>Antifungal activity of the extracts of selected marine organisms</i>	184
P-B18	Marija BANOŽIĆ, Tanja Gagić, Mojca Škerget, Stela Jokić Ekstrakcija bioaktivnih komponenti iz duhanskog otpada vodom u subkritičnom stanju <i>Subcritical water extraction of bioactive compounds from tobacco waste</i>	185
P-B19	Matija GALJER, Franjo Jović, Eugen Marcelić, Amir Avdagić Strategija razvoja procesa kristalizacije s laboratorijskog na industrijsko mjerilo <i>Crystallization process development strategy from lab to industrial scale</i>	186
P-B20	Damir ŠAHNIĆ, Dejan Kišiček, Hrvoje Dorić, Ivan Mohler, Nenad Bolf Kristalizacija farmaceutskog kokristala naprednim vođenjem prezasićenosti <i>Crystallization of a pharmaceutical cocrystal by advanced supersaturation control</i>	187

P-B21	Yu-Ri Lee, Xuan Huy Do, Kyung-Youl BAEK Post-modificirani bifunkcionalni kiselo bazni katalizator ZIF-8 za tandemsku reakciju deacetalizacije i Knoevenagelove kondenzacije u jednoj posudi <i>Post-modified acid-base bifunctional ZIF-8 catalyst for the one-pot deacetalization-Knoevenagel tandem reaction</i>	188
P-B22	Kristina BABIĆ, Ivana Grčić, Vesna Tomašić, Zoran Gomzi Fotolitička i fotokatalitička razgradnja neonikotinoidnog insekticida imidakloprida <i>Photolytic and photocatalytic degradation of neonicotinoid insecticide imidacloprid</i>	189
P-B23	Zora PILIĆ, Ivana Martinović, Gloria Zlatić <i>Helichrysum italicum</i> kao inhibitor korozije <i>Helichrysum italicum as corrosion inhibitor</i>	190
P-B24	Viola Somogyi, Maja Zebić Avdičević, Réka H. HARGITAI, Endre Domokos, Davor Ljubas, Slaven Dobrović Modeliranje separacije reaktivnog bojila primjenom ultrafiltracijske keramičke membrane <i>Modelling reactive dye removal by ultrafiltration ceramic membranes</i>	191
P-B25	Maja Zebić Avdičević, Viola Somogyi, Davor Ljubas, Endre Domokos, Slaven Dobrović, Réka H. Hargitai, Béla VARGA Ultrafiltracija otpadne vode iz procesa mercerizacije tekstila keramičkim membranama – ispitivanje radnih karakteristika i modela blokiranja pora <i>Ultrafiltration of textile mercerization wastewater using ceramic membranes – modelling fouling and performance</i>	192
P-B26	Tina POSEDI, Maja Fabulić Ruszkowski, Aleksandra Sander, Dijana Blažek, Iva Sanja Beer Romac Dvostupnjevita metoda pročišćavanja pirolitičkog ulja iz otpadnih guma <i>A two-step method for purification of waste tyre pyrolysis oil</i>	193
P-B27	Hrvoje DORIĆ, Luka Đuran, Ivan Vrban, Nenad Bolf, Jasna Prlić Kardum Odabir odgovarajućeg otapala i tipa kristalizacije za djelatnu farmaceutsku tvar fosamprenavir-kalcij <i>Definition of the appropriate solvent and crystallization type for the active pharmaceutical ingredient Fosamprenavir calcium</i>	194
P-B28	Matko Erceg, Kristina KNEZOVIĆ Utjecaj ubrzanog starenja na kinetiku izotermne razgradnje polimera <i>Influence of damp heat test on kinetics of the isothermal degradation of polymers</i>	195
P-B29	Evi Chronopoulou, Marianna Chatzikonstantinou, Panos MADESIS, Nikos E. Labrou Glutathion-transferaze slične klasi alfa, humane odnosno iz alge <i>Chlamydomonas reinhardtii</i> , kao alati za krojenje proteinskih nanostrukture <i>The human and Chlamydomonas reinhardtii alpha class-like glutathione transferases as tools for designing tailor-made protein nanostructures</i>	196
	POSTERSKA PRIOPĆENJA / POSTER PRESENTATIONS	197
	MATERIJALI / MATERIALS	
P-C1	Zvonimir KATANČIĆ, Mihovil Turniški, Hrvoje Kušić, Zlata Hrnjak-Murgić Fotokatalitičko uklanjanje bisfenola A kompozitnim katalizatorom na bazi elektrovodljivog polimera PEDOT <i>Photocatalytic removal of bisphenol A by composite catalyst based on conductive polymer PEDOT</i>	198
P-C2	Katarina MUŽINA, Ivana Katarina Munda, Vilko Mandić, Stanislav Kurajica Mehanokemijska sinteza nanočestica ZnO dopiranoga kadmijem <i>Mechanochemical synthesis of cadmium doped ZnO nanoparticles</i>	199
P-C3	Filip BRLEKOVIĆ, Valentina Dragčević, Juraj Šipušić Utjecaj kemijske obrade drvene vune na zapaljivost drvo-cementnog kompozita <i>Influence of chemical treatment of wood wool on wood-cement composite flammability</i>	200
P-C4	Milan Vukšić, Irena Žmak, Lidija Čurković, Andraž Kocjan, Petra JENUŠ Određivanje stabilnosti koncentriranih suspenzija aluminijeva oksida koje sadrže otpadni prah istoga materijala <i>Stability determination of concentrated alumina suspensions which contain waste alumina powder</i>	201
P-C5	Igor JAJČINOVIĆ, Ivan Brnardić, Ivana Grčić, Kristina Tolić Primjena i utjecaj mikrovalova na imobilizaciju fotokatalizatora TiO ₂ na nosač <i>Application and influence of microwaves on immobilization of TiO₂ photocatalyst on a carrier</i>	202
P-C6	Iva REZIĆ, Maja Somogyi Škoc, Lela Pintarić, Vanja Ljolić Bilić, Ivan Kosalec Modeliranje i ispitivanje antimikrobnih polimera <i>Modeling and testing of antimicrobial polymers</i>	203

P-C7	Yu-Han Chu, Wein-Duo YANG Elektrodepozicija pjenastih kompozitnih elektroda za superkondenzatore na osnovi MnO ₂ , grafena i nikla <i>Electrodeposition of MnO₂/graphene/nickel foam composite electrodes for supercapacitor</i>	204
P-C8	Ivan MARIĆ, Marijan Gotić, Goran Štefanić, Anđela Pustak, Tanja Jurkin Sinteza magnetskih nanočestica γ -ozračivanjem i njihova uporaba za obezbojavanje organske boje metilenskog modrila <i>γ-Irradiation synthesis of magnetic iron oxide nanoparticles and their ability to decolorize methylene blue organic dye</i>	205
P-C9	Kristina SKLEPIĆ KERHAČ, Luka Pavić, Gregory Tricot, Petr Mošner, Ladislav Koudelka, Andrea Moguš-Milanković Uloga strukturnih promjena u mehanizmu prijenosa natrijevih iona u fosfatnim staklima <i>The role of structural changes in sodium ion transport mechanism in phosphate glasses</i>	206
P-C10	Jasna HALAMBEK, Lucija Čović, Ines Cindrić Inhibicijsko djelovanje eukaliptola na koroziju aluminija u modelnim otopinama <i>Inhibitory action of eucalyptol on aluminum corrosion in model solutions</i>	207
P-C11	Elvira VIDOVIĆ, Roko Blažić, Martina Budimir Sinteza sorbensa na bazi celuloze za uklanjanje naftnih onečišćenja <i>Synthesis of cellulose based sorbents for oil spill cleanup</i>	208
P-C12	Ivana CETINA, Irina Pucić, Ana Šantić Učinak strukture amina na ishod γ -zračenja gelnih mreža na osnovi PDMS-a <i>Impact of amine structure on the outcome of γ-irradiation of PDMS-based gel networks</i>	209
P-C13	Roko BLAŽIĆ, Elvira Vidović, Boris Kremenjaš Kemijska modifikacija mikroceluloze dugolančanim metakrilatima <i>Chemical modification of microcrystalline cellulose with long chain methacrylates</i>	210
P-C14	Ivana LANDRIPET, Andreas Puškarić, Josip Bronić Utjecaj načina sinteze na morfologiju kristala zeolita Beta <i>The influence of the synthesis pathway on the morphology of zeolite beta crystals</i>	211
P-C15	Leonard BAUER, Anamarija Rogina, Maja Antunović, Inga Marijanović, Marica Ivanković, Hrvoje Ivanković Priprema magnezijem supstituiranog hidroksiapatitnog nosača – utjecaj na <i>in vitro</i> kulturu s ljudskim mezenhimskim matičnim stanicama <i>Preparation of magnesium substituted hydroxyapatite scaffold – the effect on in vitro culture with human mesenchymal stem cells</i>	212
P-C16	Irina PUCIĆ, Ivana Cetina Odziv nekih nanokompozita na osnovi poli(etilen-tereftalata) na različite vrste zračenja <i>Response of some poly(ethylene-terephthalate) based nanocomposites to various radiation types</i>	213
P-C17	Andraž KOČJAN, Ana Lazar, Eduardo Ruiz-Hitzky, Bernd Wicklein Trodimenzijske, grafenu slične mreže u sinteriranim keramičkim matricama izvedene iz celuloznih nanovlakana <i>Cellulose-nanofibres-derived 3D graphene-like networks in sintered ceramic matrices</i>	214
P-C18	Filip CAR, Vesna Tomašić, Domagoj Vrsaljko Priprema monolitnih nosača katalizatora tehnologijom 3D-ispisa <i>Preparation of monolithic catalyst supports using 3D-printing technology</i>	215
	POSTERSKA PRIOPĆENJA / POSTER PRESENTATIONS	216
	ZAŠTITA OKOLIŠA / ENVIRONMENTAL PROTECTION	
P-D1	Hrvoje Nikl, Matija Cvetnić, Tomislav Bolanča, Marko ROGOŠIĆ Razvoj uređaja za pripremu referentnog uzorka brzine strujanja i koncentracije krutih čestica u otpadnom plinu <i>Development of the device for preparation of the reference sample for the flow velocity and concentration of solid particles in waste gas</i>	217
P-D2	Josipa PAPAC, Marin Kovačić, Ana Lončarić Božić Primjena ferata(VI) za uklanjanje farmaceutika u vodi <i>Application of ferrates(VI) for the removal of pharmaceuticals in water</i>	218

P-D3	Antonija TOMIĆ, Matija Cvetnić, Tomislav Bolanča, Mirjana Novak Stankov, Šime Ukić, Hrvoje Kušić, Ana Lončarić Božić Fotooksidativna razgradnja farmaceutika i pesticida u vodi: mehanističko modeliranje <i>Photooxidative degradation of pharmaceuticals and pesticides in water: mechanistic modelling approach</i>	219
P-D4	Martina Biošić, Dario Dabić, Irena ŠKORIĆ, Sandra Babić Kinetika fotolitičke razgradnje nitrofurantoina i identifikacija produkata fotorazgradnje <i>Kinetic studies of nitrofurantoin photolysis and identification of photodegradation products</i>	220
P-D5	Hrvoje NIKL, Matija Cvetnić, Marko Rogošić, Tomislav Bolanča Međulaboratorijsko usporedbeno mjerenje brzine strujanja i koncentracije krutih čestica u otpadnom plinu <i>Interlaboratory comparison measurement of gas velocity and concentration of solid particles in the waste gas</i>	221
P-D6	Marko RACAR, Kladija Obajdin, Davor Dolar, Krešimir Košutić Ultrafiltracija kao predobrada kod uporabe sekundarnog efluenta s nanofiltracijom/reverznom osmozom: šuplja vlakna vs. ravne membrane <i>Ultrafiltration as a pretreatment for secondary effluent reclamation with nanofiltration/reverse osmosis: flat sheet vs. hollow fiber membranes</i>	222
P-D7	Nives MATIJAKOVIĆ, Damir Kralj Djelovanje različitih prirodnih i antropogenih inhibitora na taloženje kalcijeva karbonata u umjetnoj krškoj vodi <i>The influence of different natural and anthropogenic inhibitors on calcium carbonate precipitation in artificial karst water</i>	223
P-D8	Emina RAMIĆ, Jasna Huremović, Sabina Žero, Almir Olovčić SEM/EDS analiza epifitskog lišaja <i>Evernia prunastri</i> kao bioindikatora onečišćenja zraka SEM/EDS analysis of the epiphytic lichen <i>Evernia prunastri</i> as the bioindicator of air pollution	224
P-D9	Elma ŠABANOVIĆ, Mustafa Memić Mehanizam uklanjanja U(VI) iona biosorpcijom iz vodenih otopina <i>Biosorption removal mechanism of U(VI) ions from aqueous solution</i>	225
P-D10	Vlatka GVOZDIĆ, Dinko Puntarić, Marina Vidosavljević, Matijana Jergović, Dragana Jurić, Miroslav Venus, Lidija Bijelić, Ada Puntarić Određivanje koncentracija arsena u uzorcima urina i seruma stanovnika istočne Hrvatske metodom ICP-MS <i>Determination of arsenic in urine and serum samples with ICP-MS in areas of eastern Croatia</i>	226
P-D11	Ines CINDRIĆ, Jasna Halambek Uklanjanje bojila metilenskog modrila iz vodene otopine predobrađenom ljuskom jajeta <i>Removal of methylene blue dye in aqueous solution by pretreated eggshells waste</i>	227
P-D12	Mirjana ČURLIN, Marjana Simonić Efikasnost uklanjanja kemijske potrošnje kisika uljno vodenih emulzija procesom elektrokoagulacije <i>Chemical oxygen demand removal efficiency of oily water emulsion by electrocoagulation</i>	228
P-D13	Zdravka SEVER ŠTRUKIL, Ivana Jakovljević, Ranka Godec, Gordana Peh nec Karakterizacija policikličkih aromatskih ugljikovodika u PM ₁₀ i PM _{2,5} frakciji u Zagrebu <i>Characterization of polycyclic aromatic hydrocarbons in PM₁₀ and PM_{2,5} fraction in Zagreb</i>	229
P-D14	Iva ŠIMIĆ, Gordana Mendaš Starčević, Gordana Peh nec Određivanje atmosferskog taloženja policikličkih aromatskih ugljikovodika i polikloriranih bifenila <i>Determination of the atmospheric deposition of polycyclic aromatic hydrocarbons and polychlorinated biphenyls</i>	230
P-D15	Valentina GLUŠČIĆ, Gordana Peh nec, Mirjana Čačković, Silva Žužul Trend kiselih komponenti u ukupnoj taložnoj tvari u zagrebačkom zraku <i>Trend of acidic compounds in total deposited matter in Zagreb air</i>	231
P-D16	Ana ALEBIĆ-JURETIĆ, Dario Kontošić, Velimir Zubak Frakcije lebdećih čestica u atmosferi grada Rijeke <i>Fractions of airborne particulates in Rijeka, Croatia</i>	232
P-D17	Tea BOROJEVIĆ, Ivana Mađor-Božinović, Darko Andrić, Danijela Ašperger, Davor Dolar Praćenje organskih onečišćivala u čakovečkim otpadnim vodama <i>Monitoring of organic pollutants in wastewater from Čakovec area</i>	233

P-D18	Dino PEROVIĆ, Ana Lončarić Božić, Hrvoje Kušić, Zlata Hrnjak Murgić Utjecaj kružnog gospodarstva na projektirani kapacitet centra za gospodarenje otpadom Biljane Donje <i>The impact of the circular economy on the projected capacity of the waste management center Biljane Donje</i>	234
P-D19	Zdravka Lovinčić Kraljević, Dubravka MADUNIĆ-ČAČIĆ Razgradnja anionskih tenzida UV-C/H ₂ O ₂ procesom u otpadnim vodama detergentske industrije s posebnim naglaskom na razgradnju NaDBS-a <i>Degradation of anionic surfactants by the UV-C/H₂O₂ process in of the detergent industry effluents with special emphasis on NaDBS degradation</i>	235
	POSTERSKA PRIOPĆENJA / POSTER PRESENTATIONS	236
	OBRAZOVANJE / EDUCATION	
P-E1	Marijana MAGDIĆ, Valentina Ćosić Bršljan za tebe – želim stablo <i>Ivy for you – I wish a tree</i>	237
P-E2	Magdalena Lugarić, Petra Marija Rajković, Marija Tankosić, Mirjana KRPAN Utjecaj toksičnosti kalijeva nitrata na malezijskog svrdlastog puža <i>Influence of potassium nitrate toxicity on the Malaysian dwarf snail</i>	238
	RADIONICE / WORKSHOPS	239
WS-1	Andrew J. T. SHORE Objaviti istraživanje iz područja kemijskih znanosti u časopisima izdavača Royal Society of Chemistry <i>Publishing your chemical sciences research with the Royal Society of Chemistry</i>	240
WS-2	Ines TOPALOVIĆ, Mislav Matić, Irena Milardović, Marina Bekavac, Leo Bolješić, Ema Podravski, Leonarda Vugrin, Karla Ribičić Kojim putem krenuti? <i>Which way to go?</i>	241
WS-3	Tetiana KHRISTOVA SciFinder ⁿ – izbor za istraživanje iz područja kemije te bioloških i biotehničkih znanosti <i>SciFinderⁿ – the choice for chemistry and life science research</i>	242
WS-4	Vladimir STILINOVIĆ, Dominik Cinčić Javni nastup za kemičare – dobar, loš i gadan <i>Public speaking for chemists – the good, the bad, and the ugly</i>	243
	PARALELNE RADIONICE SEKCIJE OBRAZOVANJE /	244
	PARALLEL WORKSHOPS OF THE EDUCATION SECTION	
WSE-1	Tajana PREOČANIN, Sanja ŽUŽEK, Sonja RUPČIĆ PETELINC, Helena PETER JELEŃIĆ How to write a chemistry problem (workshop) <i>Kako napisati zadatak iz kemije (radionica)</i>	245
WSE-2	Nikolina PENIĆ, Draginja Mrvoš-Sermek Nastava kemije za svakog učenika – Gardnerova teorija <i>Chemistry education adjusted to each student – Gardner's theory</i>	246
WSE-3	Nenad ŽIDAK, Draginja Mrvoš-Sermek Sapuni i detergensi – zelena kemija u nastavi <i>Soaps and detergents – green chemistry in teaching</i>	247

PLENARNA PREDAVANJA

PLENARY LECTURES

Mastering digitized chemical engineering Ovladavanje digitaliziranim kemijskim inženjerstvom

Dr. Hermann J. Feise,¹ Eric Schaer²

¹*European Federation of Chemical Engineering, Rugby, United Kingdom and BASF SE, Ludwigshafen, Germany*

²*Universite de Lorraine, Nancy, France*

E-mail: Hermann.Feise@basf.com

The chemical industry with its large world scale production units and its multi-purpose facilities is one of the energy-, raw materials- and capital-intensive industries, which currently face the challenges of the digital transformation. In these conditions, the chemical engineer's activities also have to evolve.

The digital transformation or Industry 4.0 is expected to change business models, allowing new efficiency gains and improving European competitiveness. In the chemical industry much of the key aspects of the digital transformation are not foreign: Internet of Things, Industrial Internet or automated ordering, have a strong history in process optimization and automation. However, logistics and maintenance are the only two fields which have developed truly digital workflows. The way to a truly digitally transformed plant is still very long.

A digitally transformed chemical plant will lead to new challenges and new opportunities for chemical engineers. New tasks will be developed and colleagues with new competencies and different skills will work together with chemical engineers. This will require additive knowledge from the chemical engineer which are not part of today's engineering skill set, although some of them have been for previous generations of chemical engineers.

Drivers for the digital transformation can be found in various areas, *e.g.* data management systems, digital data, improved sensors for control, connectivity, simulation, spatial data. While the use of smart sensors for control has always been part of chemical engineering, neither their design or their use for simulation and optimization tools are mainstream chemical engineering tasks. Digital transformation will logically lead to the use and application of artificial intelligence systems in the industry, and should require, for example, strong knowledge and skills in (transient) simulation and optimization. This should also require an ability to critically evaluate the results provided by such systems.

The presentation will provide examples of "digital chemical engineering" and discuss expectations concerning engineering competencies needed of digitized Chemical Engineering and how these will influence chemical engineering education.

Electron microscopic methods to investigate morphology and micromechanical processes of polymers Metode elektronske mikroskopije za istraživanje morfologije i mikromehaničkih procesa u polimerima

Sven Henning,¹ Goerg H. Michler²

¹Fraunhofer IMWS, Halle (Saale), Germany

²Martin Luther University Halle-Wittenberg, Halle (Saale), Germany

E-mail: sven.henning@imws.fraunhofer.de

Electron microscopy is a powerful tool for the imaging of polymer morphology, *i.e.*, the visualization of micro- and nanostructures that determine the properties of polymeric materials. The lecture provides an overview of standard electron microscopic techniques. Relevant transmission (TEM) and scanning electron beam (SEM) contrast and image formation principles are briefly summarized. These general considerations are followed by a short round-up of recent developments in electron microscopic polymer characterization. The presentation covers different preparation routes with a special emphasis on preparation by means of cryo-ultramicrotomy and focused ion beam techniques, including essential etching and staining procedures.

One important task is to quantify morphological parameters and to correlate such data to synthesis, processing, and properties. Therefore, some aspects of digital image processing, correlative and 3D microscopy are discussed. Micromechanical analyses are performed to describe deformation phenomena that occur under mechanical load, as there are crazing, homogeneous deformation, shear band formation, nano-void formation and fibrillation that can be related to brittle, semi-ductile or ductile mechanical behavior. A set of examples will be discussed to illustrate typical problems, results and applications (Figure 1).

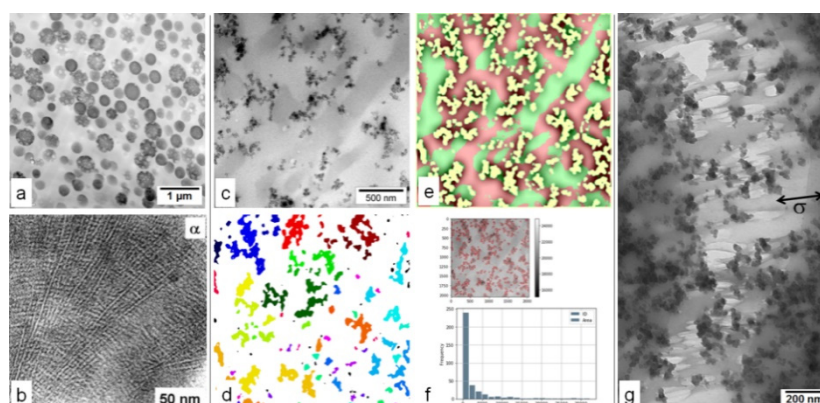

Figure 1: a) latex particles, b) semicrystalline morphology of α -iPP, c-f) imaging, visualization and detection of morphological features of a particle-filled polymer blend by means of digital image processing, g) investigation of micromechanical processes in a nanocomposite. TEM images from cryo-ultrathin sections after staining.

References

- [1] G. H. Michler, *Electron Microscopy of Polymers*, Springer Laboratory, Berlin Heidelberg, 2008.
- [2] L. Sawyer, D. Grubb and G. F. Meyers, *Polymer Microscopy*, 3rd ed., Springer, New York, 2008.
- [3] G. H. Michler and F. J. Baltá-Calleja, *Nano- and Micromechanics of Polymers*, Hanser, München, 2012.
- [4] G. H. Michler, *Atlas of Polymer Structures*, Hanser Publishers, Munich, 2016.

Structural flexibility in the solid state – implications for porous materials Strukturna fleksibilnost u čvrstom stanju – implikacije za porozne materijale

Len Barbour

Department of Chemistry and Polymer Science, University of Stellenbosch, Stellenbosch, South Africa

E-mail: ljb@sun.ac.za

In order to understand solid-gas inclusion processes at the molecular level it is important to correlate physico-chemical data (*e.g.* sorption isotherms and calorimetric analysis) with structural data. It is therefore desirable to carry out structural elucidation and calorimetric analysis under conditions that closely mimic those of the sorption/desorption experiments. However, the crystallographic analysis of samples under controlled gas environments poses significant technical challenges, particularly given the limited space associated with the sample compartment of standard commercial diffractometer. In this regard, an environmental gas cell has been developed in parallel with a pressure-programmed differential scanning calorimeter. Use of these complementary techniques has provided new insight into features such as pressure-induced phase transformations (Figure 1) that give rise to inflections and hysteresis in sorption isotherms. The influence of guest molecules on aspects such as structural flexibility and changes in network interpenetration will be discussed.

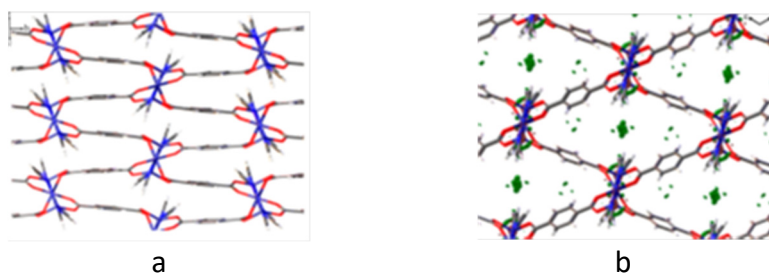

Figure 1: A flexible breathing MOF (a) before and (b) after a gas-induced phase transition [1].

References

[1] P. Lama and L. J. Barbour, *J. Am. Chem. Soc.* **140** (2018) 2145-2150.

Treatment of contaminants of emerging concern in water and water reuse using homogeneous and heterogeneous advanced oxidation processes
Obrada “novih zagađivala” u vodi homogenim i heterogenim naprednim oksidacijskim procesima i uporaba tako obrađene vode

Prof. Dionysios (Dion) D. Dionysiou
Environmental Engineering and Science Program
Department of Chemical and Environmental Engineering (ChEE)
University of Cincinnati, Cincinnati, Ohio, USA

E-mail: dionysios.d.dionysiou@uc.edu

In recent years, contaminants of emerging concern (CECs) are frequently detected in treated wastewater effluent and sources of drinking water supplies. As technologies implemented to the traditional treatment train, advanced oxidation processes (AOPs) significantly reduce the level of CECs and improve the quality of the effluent for further reuse (*i.e.*, direct and indirect potable reuse). In this presentation, Prof. Dionysiou will present examples of his work on the degradation of CECs using heterogeneous (*i.e.*, semiconductor photocatalysis, photo-Fenton-like, dark-based catalytic) and homogeneous (UV/H₂O₂, UV/persulfate, UV/chlorine) AOPs for application related to water treatment and reuse applications. Details on the mechanism of degradation of cyanotoxins, pharmaceuticals, pesticides, sunscreen ingredients and other CECs by hydroxyl radical, sulfate radical, chlorine related radicals, and other reactive species generated in various AOPs will be provided. Synthesis of novel photocatalytic materials and aspects on modeling and structure-activity relationships will be presented. Finally, integration of AOPs with conventional and other advanced technologies for the removal of CECs in water reuse will be showcased.

How to make maximum use of the available pK_a data in non-aqueous solvents?

Kako maksimalno iskoristiti dostupne podatke o pK_a vrijednostima u nevodenim otapalima?

Ivo Leito, Agnes Kütt, Sigrid Selberg, Ivari Kaljurand, Sofja Tshepelevitsh, Agnes Heering, Astrid Darnell, Karl Kaupmees, Mare Piirsalu
University of Tartu, Institute of Chemistry, Tartu, Estonia

E-mail: ivo.leito@ut.ee

Expressing the strengths of acids and bases in water is well established, using the pK_a values. The acid and base strengths in non-aqueous solvents are different (and can be dramatically different) from water [1]. They depend on solvation of the proton, as well as of the neutral and ionized form of the acid/base. Since every solvent is different, the pK_a values in them are also different.

In principle, whenever using pK_a values for rationalizing chemical processes, the pK_a values determined in the same solvent should be used. In some non-aqueous solvents, *e.g.* DMSO [2] or acetonitrile [3,4] large bodies of pK_a data exist, while in most solvents either very few pK_a values are available or none at all. This leads to the frequent need of estimating pK_a values on one solvent from the data in other solvent(s).

When estimating pK_a values across solvents it is important to clearly define the aim. Is it needed to have the absolute pK_a value or is it rather necessary to have the acidity/basicity differences (or acidity/basicity order) within a set of compounds? Perhaps the question is just "can base B deprotonate acid A in solvent S"? If absolute pK_a value is needed then what accuracy is necessary? This presentation gives an overview to what extent such estimates can be reliably done, highlighting both successes and failures [1].

References

- [1] A. Kütt, S. Selberg, I. Kaljurand, S. Tshepelevitsh, A. Heering, A. Darnell, K. Kaupmees, M. Piirsalu and I. Leito, *Tetrahedron Lett.* **59** (2018) 3738-3748.
- [2] F. G. Bordwell, *Acc. Chem. Res.* **21** (1988) 456-463.
- [3] I. Kaljurand, A. Kütt, L. Sooväli, T. Rodima, V. Mäemets, I. Leito and I. A. Koppel, *J. Org. Chem.* **70** (2005) 1019-1028.
- [4] A. Kütt, I. Leito, I. Kaljurand, L. Sooväli, V. M. Vlasov, L. M. Yagupolskii and I. A. Koppel, *J. Org. Chem.* **71** (2006) 2829-2838.

Helically chiral aromatics: their synthesis, properties and applications Helikalni kiralni aromati: sinteza, svojstva i primjene

Ivo Starý,¹ Irena G. Stará,¹ Michal Šámal,¹ Jindřich Nejedlý,¹ Jiří Rybáček,¹ Jaroslav Vacek,¹
Ladislav Sieger,¹ Oleksandr Stetsovych,² Martin Švec,² Pavel Jelínek²

¹Institute of Organic Chemistry & Biochemistry CAS, Prague Czech Republic

²Institute of Physics CAS, Prague, Czech Republic

E-mail: stary@uochb.cas.cz

The preparation of nontrivial helically chiral aromatics and exploration of their physico-chemical properties attracts a considerable attention these days. Hand in hand with the development in their synthesis, an increasing number of applications to chemistry, physics and biology has been described in the literature [1]. Relying on a robust [2+2+2] alkyne cycloisomerisation, we have demonstrated the successful synthesis of a wide range of helically chiral (hetero)helicenes encompassing functionalised, laterally/axially extended and enantiopure derivatives [2].

We will present the synthesis of a series of (hetero)helicenes and (hetero)helicene-like compounds equipped with various functional groups being prepared in a racemic or enantiopure form. We will focus also on their unique chemical/physical properties and applications to catalysis, physics or nanoscience. In particular, the single-molecule conductivity [3], piezoelectric behaviour [4], spectroscopic properties, on-surface chirality transformation [5] and use in asymmetric catalysis will be discussed.

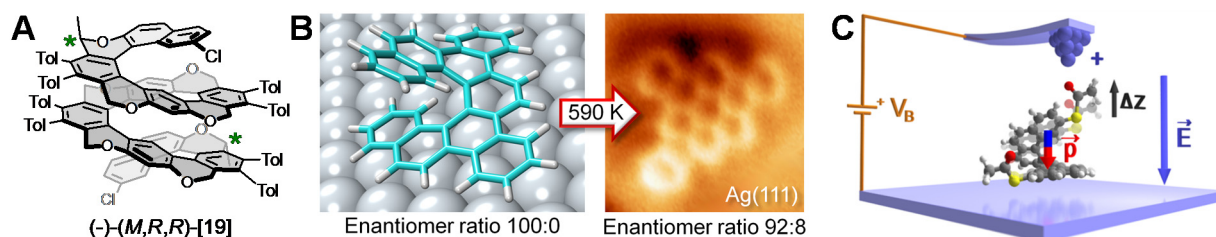

Figure 1: The longest [19]helicene-like molecule (A) [3], on-surface transformation of dibenzo[7]helicene (B) [5], single-molecule converse piezoelectric effect measured at the functionalised [7]helicene (C) [4].

References

- [1] C. F. Chen and Y. Shen, *Helicene Chemistry: From Synthesis to Applications*; Springer-Verlag: Berlin, **2017**.
- [2] M. Šámal, S. Chercheja, J. Rybáček, J. Vacek Chocholoušová, J. Vacek, L. Bednárová, D. Šaman, I. G. Stará and I. Starý, *J. Am. Chem. Soc.* **137** (2015) 8469-8474.
- [3] J. Nejedlý, M. Šámal, J. Rybáček, M. Tobrmanová, F. Szydło, C. Coudret, M. Neumeier, J. Vacek, J. Vacek Chocholoušová, M. Buděšínský, D. Šaman, L. Bednárová, L. Sieger, I. G. Stará and I. Starý, *Angew. Chem. Int. Ed.* **56** (2017) 5839-5843.
- [4] O. Stetsovych, P. Mutombo, M. Švec, M. Šámal, J. Nejedlý, I. Císařová, H. Vázquez, M. Morolagares, J. Berger, J. Vacek, I. G. Stará, I. Starý and P. Jelínek, *J. Am. Chem. Soc.* **140** (2018) 940-946.
- [5] O. Stetsovych, M. Švec, J. Vacek, J. Vacek Chocholoušová, A. Jančařík, J. Rybáček, K. Kosmider, I. G. Stará, P. Jelínek and I. Starý, *Nat. Chem.* **9** (2017) 213-218.

POZVANA PREDAVANJA

INVITED LECTURES

From rational structural design to enhanced efficiency and stability of light-emitting diodes: 2D and quasi 2D hybrid perovskites

Od racionalnog strukturnog dizajna do poboljšane učinkovitosti i stabilnosti svjetlosnih dioda: 2D i kvazi-2D hibridni perovskiti

Jasminka Popović,¹ Aleksandra Djurišić,² Ivor Lončarić,¹ Luca Grisanti,¹ Martina Vrankić,¹
Željko Skoko¹

¹Ruđer Bošković Institute, Zagreb, Croatia

²Hong Kong University, Hong Kong

E-mail: jpopovic@irb.hr

A class of the 3D hybrid perovskites does not stop impressing optoelectronic and photovoltaic community with their rapid improvements in performance since the first demonstration in 2009. [1] Perovskite-based solar cells (SCs) have demonstrated unprecedented progress on efficiency in the history of photovoltaics; power conversion efficiencies have steeply grown from 3% to 23%. [1] The structure of 3D hybrid perovskite, typically (MA)PbX₃ (MA=methylammonium) is a 3D network of corner-shared BX₆ octahedrons with an organic cation A located within the octahedral layers. One of the major concerns regarding 3D hybrid perovskite SCs is an insufficient long-lasting stability. [2] To address this issues, a mixing of 3D perovskite with its 2D derivatives (obtained by “slicing” the 3D frameworks into a well-defined 2D slabs) have been recently proposed. [3] The 2D perovskites are described by the formula: **A₂A'_{n-1}B_nX_{3n+1}** where: **A** is a large organic cation (typically buthylammonium, BA or phenylethylammonium, PEA) **A'** is a smaller organic cation (commonly MA), **B** is a divalent metal cation (Pb or Sn), **X** is halide and **n** is number of [BX₆]⁴⁻ octahedral layers. Those lower perovskites have higher bandgaps compared to 3D materials, thus they are of significant interest for the light emitting applications. They also represent an excellent working platform, extremely versatile and highly tailorable, because properties can be tuned not only by the choice of organic cations and halide anions, but also by changing *n* value that defines the thickness of the perovskite layer. This talk will address the correlation between specific structural and compositional features, tailored by the choice of perovskite building blocks (thickness of perovskite slab *n*, choice of halide anion but particularly the choice of A cation) on improved ambient stability and enhanced efficiency of 2D and quasi-2D halide perovskite materials. [4] In particular, the possibility of utilization of mixed cations in spacer layer will be discussed; (BA_{0.5}PEA_{0.5})₂MAPb₂Br₇ do not exhibit the downfalls typical for each endmember, while the advantages of both endmembers are successfully retained. High phase purity of *n*=2, similar to BA₂MAPb₂Br₇, is retained as well as improved ambient and thermal stability, similar to PEA₂MAPb₂Br₇.

References

- [1] A. Kojima, K. Teshima, Y. Shirai and T. Miyasaka, *J. Am. Chem. Soc.* **131** (2009) 6050-6051.
- [2] G. Niu, X. Guo and L. Wang, *J. Mater. Chem. A*, **3** (2015) 8970-8980.
- [3] Q. Tai, P. You, H. Sang, Z. Liu, C. Hu, H. L. Chan and F. Yan, *Nature Commun.* **7** (2016) 11105 (1-8).
- [4] M. K. Wong, F. Liu, C. S. Kam, T. L. Leung, H. W. Tam, A. B. Djurišić, J. Popović, H. Li, K. Shih, K.-H. Low, W. K. Chan, W. Chen, Z. He, A. Ng and C. Surya, *Chem. Mater.* **29** (2017) 9946-9953.

***In situ* monitoring of mechanochemical reactions for new advances in solid-state chemistry**

***In situ* praćenje mehanokemijskih reakcija za daljnji razvoj kemije čvrstog stanja**

Krunoslav Užarević

Ruđer Bošković Institute, Zagreb, Hrvatska

E-mail: krunoslav.uzarevic@irb.hr

Mechanochemical transformations of solids are emerging as important green and energy-efficient synthetic alternative to conventional solution procedures. Despite their growing importance and broad applications to various classes of materials, mechanisms and kinetics of these solvent-free reactions are only now becoming unraveled through the development of *in situ* monitoring methods based on powder X-ray diffraction (PXRD) [1,2], Raman spectroscopy [3], and high-precision temperature monitoring [4]. These advanced techniques, used either alone or in tandem, allowed for real-time insight into the course of these solid-state reactions without the need to interrupt them for sampling, gaining unprecedented data about the mechanisms and kinetics of the monitored reactions.

This talk will focus on several archetypal organic or coordination reactions where the *in situ* monitoring revealed a rich variety of mechanisms, involving solid-state selectivity, amorphization, recrystallization and various phase transformations. We will show here how the correlation between the reaction conditions and the occurrence of particular crystal form could be successfully used for governing the solvent-free reaction and isolation of target metastable forms, some of which are not accessible from solution. Herein presented results demonstrate the suitability of *in situ* monitoring techniques for further development of mechanochemistry for controllable synthesis of various materials, and also provide an important contribution to the development of new models of their reactivity.

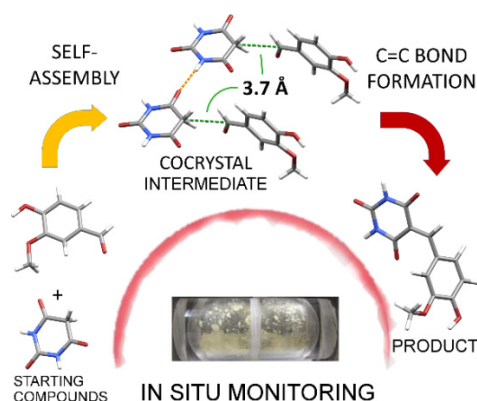

Figure 1: Mechanochemical C–C bond forming reaction proceeds through self-assembly of a cocrystal intermediate.

References

- [1] T. Friščić et al., *Nature Chem.* **5** (2013) 66-73.
- [2] K. Užarević, I. Halasz and T. Friščić, *J. Phys. Chem. Lett.* **6** (2015) 4129-4140.
- [3] D. Gracin et al., *Angew. Chem. Int. Ed.* **53** (2014) 6193-6197.
- [4] K. Užarević et al., *Chem. Sci.* **9** (2018) 2525-2532.

Application of combined computational chemistry and cheminformatics methods in properties assessment of nanomaterials

Primjena kombiniranih metoda računalne kemije i keminformatike u procjeni svojstava nanomaterijala

Bakhtiyor Rasulev

Department of Coatings and Polymeric Materials, North Dakota State University, Fargo, USA

E-mail: bakhtiyor.rasulev@ndsu.edu

It is apparent that functional materials are ubiquitous nowadays. Nanoscale materials find use in a variety of different areas, such as electronic, magnetic and optoelectronic, biomedical, pharmaceutical, cosmetic, energy, environmental, catalytic, and materials applications. Based on the materials science news that comes almost every day, the new materials with improved functionality are in high demand in the marketplace. Moreover, this need increases in an exponential way for the new materials of desired functionality and performance.

In this regard, the development of approaches that effectively estimate the physico-chemical properties and biological activity of new materials in advance of mass production is very important. Since nanomaterials are complex entities from a chemical point of view, the study of these kind of materials requires an interdisciplinary approach, involving multiple aspects ranging from physics and chemistry to biology and informatics. In addition, it is very important to investigate a possible environmental impact of available nanomaterials and new ones. For example, lack of available data and low adequacy of experimental protocols prevent comprehensive toxicological risk assessment of nanomaterials. Here we show the application of computational and cheminformatics methods in nanomaterials properties prediction, including physico-chemical properties and toxicity. The discussed nanomaterials include metal oxides, functionalized fullerenes and carbon nanotubes.

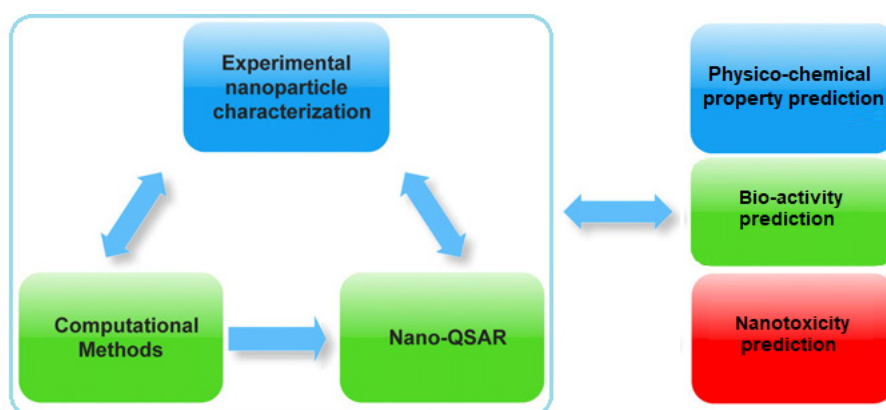

Figure 1: Scheme of combined computational nanomaterials' properties prediction.

References

- [1] B. Rasulev, *Nanotoxicity predictive modeling: A case study on metal oxides nanoparticles*, Proceedings of 256th American Chemical Society Meeting, ACS (2018), Boston, MA, US.
- [2] T. Puzyn, B. Rasulev, A. Gajewicz, X. Hu, T. P. Dasari, A. Michalkova, H. M. Hwang, A. Toropov, D. Leszczynska and J. Leszczynski, *Nat. Nanotechnol.* **6** (2011) 175-178.

Theoretical calculation of explosive performance Teorijsko izračunavanje performansi eksploziva

Muhamed Sućeska

Sveučilište u Zagrebu, Rudarsko-geološko-naftni fakultet, Zagreb, Hrvatska

E-pošta: msuceska@rgn.hr

Detonacija je proces slojevitog prostiranja kemijskih reakcija po eksplozivnoj tvari nadzvučnom brzinom (do 10 km s^{-1}). Detonacija se "vidi" kao udarni val praćen uskom zonom brzih kemijskih reakcija [1]. Te se reakcije odvijaju u ekstremnim uvjetima tlaka (do 40 GPa), temperature (do 6000 K) i u iznimno kratkom vremenu (nekoliko nanosekunda do nekoliko mikrosekunda) [2]. Zbog takvih uvjeta energija se iz zone kemijskih reakcija u neizreagirani sloj prenosi udarnim valom (tj. gibanjem), dok je prijenos provođenjem topline zanemariv. Iniciranje i prostiranje detonacije tretira se kao hidrodinamički i termodinamički problem, nadopunjen kemijskom ravnotežom i kinetikom [2].

Pouzdanost eksperimentalno određivanje pojedinih detonacijskih parametara, zbog njihovih ekstremnih vrijednosti, otežano je, a u nekim slučajevima i nemoguće. Stoga je teorijsko izračunavanje ponekad jedini način da se dobiju njihove vrijednosti.

U ovom izlaganju prikazat će se kako se primjenom hidrodinamičke teorije detonacije, te uz korištenje kemijske ravnoteže, kinetike i termokemije mogu izračunati detonacijski parametri (koncentracija pojedinih detonacijskih produkata, detonacijska brzina i tlak, detonacijska temperatura i toplina itd.), struktura detonacijskog vala (vremenski profil tlaka, temperature, brzine čestica itd.) i u konačnici predvidjeti performanse (radna sposobnost) eksplozivnih tvari. Bit će posebno govora o kemijskoj ravnoteži u višekomponentnom i višefaznom reakcijskom sustavu koji čine detonacijski produkti, te o važnosti jednadžbe stanja plinovitih i kondenziranih detonacijskih produkata za točnost izračuna.

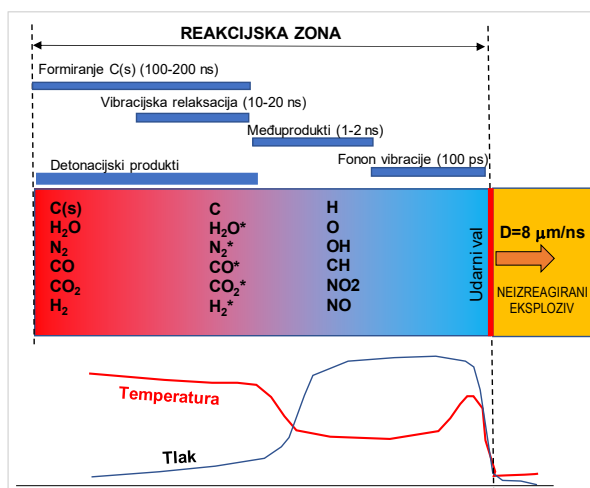

Slika 1: Struktura reakcijske zone.

Reference

- [1] G. M. Tarver i M. R. Manna, *Chemistry at Extreme Conditions*, Elsevier Science, Amsterdam, 2005.
- [2] W. Fickett i W. C. Davis, *Detonation Theory and Experiment*, Dover Publications Inc., New York, 1979.

How can NMR spectroscopy reveal binding epitopes of macrolide antibiotics? Kako spektroskopija NMR može odrediti vezne epitope makrolidnih antibiotika?

Predrag Novak

Department of Chemistry, Faculty of Natural Science, University of Zagreb

E-mail: pnovak@chem.pmf.hr

Macrolide antibiotics are effective therapeutic agents for treating infectious diseases owing to their high efficacy and safety [1,2]. Macrolides bind to the bacterial ribosomal 23S rRNA at the peptidyl transferase region and block the exit of the nascent peptide. In spite of a number of existing macrolide antibiotics, the emerging multi-drug resistant microbial pathogens present serious and challenging issues in medical treatment which demands novel and more effective antimicrobial agents to be discovered. An effective approach to overcoming this problem is to understand the principles of how these drugs interact with the ribosome.

NMR spectroscopy is one of the most powerful and valuable methods in conformational analysis and structure-based drug design. We have shown that an approach which combines one- and two-dimensional NMR methods and molecular modelling calculations could successfully be applied to conformational analysis of free and bound macrolides [3]. Furthermore, NOE based NMR techniques such as transferred NOE (tr-NOE) and saturation transfer difference (STD) provide further information on the bound state conformation and binding epitopes [4]. The application of NMR diffusion and solvent paramagnetic relaxation experiments can further reveal interaction strength and localization of macrolide antibiotics bound to their targets [4,5]. In this talk the binding epitopes of macrolide interactions with ribosomes, membrane mimetics and bile acids will be discussed.

The knowledge gained from these studies can serve as a platform for the design of novel compounds with an improved biological profile.

References

- [1] B. Arsić, P. Novak, M.G. Rimoli, J. Barber, G. Kragol and F. Sodano, *Macrolides: Properties, Synthesis and Applications*, De Gruyter, Berlin, 2018.
- [2] B. Arsic, J. Barber, A. Čikoš, M. Mladenović, N. Stanković and P. Novak, *Int. J. Antimicrob. Agents* **51** (2018) 283-298.
- [3] P. Novak, I. Tatić, P. Tepeš, S. Koštrun and J. Barber, *J. Phys. Chem. A* **110** (2006) 580-588.
- [4] S. Kosol, E. Schrank, M. Bukvić Krajačić, G. E. Wagner, H. Meyer, C. Göbl, G. N. Rechberger, K. Zangger and P. Novak, *J. Med. Chem.* **55** (2012) 5632-5636.
- [5] S. Glanzer, S. A. Pulido, S. Tutz, G. E. Wagner, M. Kriechbaum, N. Gubensäk, J. Trifunović, M. Dorn, W. M. F. Fabian, P. Novak and J. Reidl, *Chem. Eur. J.* **21** (2015) 4350-4358.

3D print as a technology for the preparation of oral dosage forms of controlled release

3D-tisak kao tehnologija za pripremu oralnih dozirnih oblika kontroliranog oslobađanja

Gordana Matijašić

Sveučilište u Zagrebu, Fakultet kemijskog inženjerstva i tehnologije, Zagreb, Hrvatska

E-pošta: gmatijas@fkit.hr

Oralno doziranje najzastupljeniji je oblik primjene lijekova zbog svoje jednostavnosti primjene. Konvencionalne metode proizvodnje tableta potječu još iz 19. stoljeća. Razvojem znanja i potreba za personaliziranjem lijekova dolazi do potrebe za uvođenjem novih tehnologija u farmaceutsku industriju. Prva 3D tiskana tableta, Spritam[®], odobrena od strane američke Agencije za hranu i lijekove, dovela je do naglog interesa za primjenom ove tehnologije u pripravi oralnih dozirnih oblika. Istraživanja su grupirana u dva smjera. Prvi uključuje razvoj tzv. višedjeljnih dozirnih oblika koji podsjećaju na konvencionalne kapsule, ali uz omogućenu kontrolu oslobađanja djelatne tvari. Druga grupa istraživanja usmjerena je na razvoj filamenata u koje je ugrađena djelatna tvar, pomoću kojih mogu biti tiskane tablete različite geometrije i oblika upotrebom tehnologije taložnog srašćivanja (engl. *fused deposition modeling*, FDM). Cijela ideja ima za cilj oblikovanje lijekova prema potrebama pacijenata uz jednostavnu izradu trodimenzionalnih računalnih modela i mogućnost tiskanja složenih oblika.

U ovom predavanju bit će prikazani rezultati istraživanja primjene 3D-tiska za pripremu oralnih dozirnih oblika, kapsula i tableta (Slika 1). Predstavit će se dizajn dva modela kapsula koje su tiskane iz poli(vinil-alkohola), biorazgradljivog farmaceutski prihvatljivog polimera. Rezultati ispitivanja *in vitro* oslobađanja djelatne tvari pokazuju mogućnost upotrebe ovih kapsula za istovremenu oralnu administraciju više djelatnih tvari te mogućnost kontrole odgode oslobađanja. Drugi dio istraživanja obuhvaća pripremu filamenata s ugrađenom djelatnom tvari iz kojih su 3D-tiskom proizvedene tablete produljenog oslobađanja.

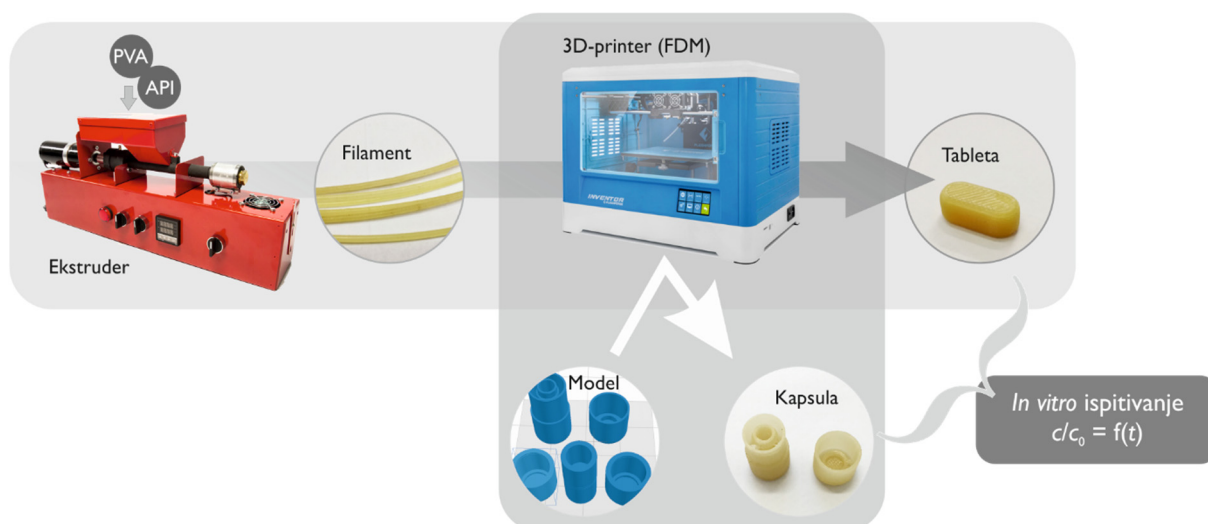

Slika 1: Shematski prikaz pripreme kapsula i tableta.

**Extending the scope of NMR spectroscopy – high resolution and direct
reaction monitoring**
**Proširenje djelokruga NMR spektroskopije – visoka rezolucija i izravno
promatranje kemijskih reakcija**

Sebastian Tasotti,¹ Simon Glanzer,¹ Predrag Novak,² N. Helge Meyer,¹
Gabriel Wagner¹, Klaus Zangger¹

¹University of Graz, Graz, Austria

²University of Zagreb, Faculty of Science, Zagreb, Croatia

E-mail: klaus.zangger@uni-graz.at

NMR spectroscopy is a versatile tool to determine structural, chemical and physical properties of molecules. Although NMR spectroscopy is now used on a routine basis for the characterization of small and medium sized molecules, new techniques which extend the range of applicability continue to emerge. In this presentation, novel techniques to significantly enhance the resolution of NMR spectrometers are described. For example the collapse of ¹H signals into singlets has been suggested to be a solution to overcome the problem of poor signal separation in ¹H-NMR spectroscopy. Indeed, the gain in resolution obtained in ¹H spectra by broadband proton decoupling can compete with the theoretical signal dispersion of regular spectra at several GHz, as recently pointed out [1-3].

The information power of NMR can also be used to monitor chemical reactions. While this application is typically only used for slow reactions to study individual reaction time points, it is also possible to follow very fast reactions directly in the NMR tube by using injection devices in combination with very fast data acquisition schemes [4].

References

- [1] J. A. Aguilar, S. Faulkner, M. Nilsson and G. A. Morris, *Angew. Chem.* **49** (2010) 3901-3903.
- [2] N. H. Meyer and K. Zangger, *Angew. Chem.* **52** (2013) 7143-7146.
- [3] S. Glanzer and K. Zangger, *J. Am. Chem. Soc.* **137** (2015) 5163-5169.
- [4] G. Wagner, P. Sakhaii, W. Bermel and K. Zangger, *Chem. Commun.* **49** (2013) 3155-3157.

Several faces of human dipeptidyl peptidase III Nekoliko lica ljudske dipeptidil-peptidaze III

Sanja Tomić, Antonija Tomić, Sara Matić, Mihaela Matovina
Ruđer Bošković Institute, Zagreb, Croatia

E-mail: sanja.tomic@irb.hr

Molecular recognition, binding and catalysis are ongoing processes in all known living organisms. Understanding these processes helps understanding development of life, the cause of diseases and ways to treat them. In my talk I will describe our research activities related to human dipeptidyl peptidase III (hDPP III), a member of the M49 enzyme family. Human DPP III is a cytosolic, two-domain metallopeptidase, with the zinc cation participating in the peptide bond hydrolysis. It is involved in the intracellular protein catabolism, pain modulation and defense against oxidative stress [1,2]. Its broad specificity toward peptides of varying lengths and compositions is still not properly understood although it could be partially understood by its ability to fluctuate between an open form with a wide inter-domain cleft (~ 40 Å wide and ~ 20 Å high), and a more compact one referred as closed (PDB codes 3FVY and 5EGY, respectively). Results of our computational study on conformational dynamics, ligand binding and enzymatic mechanism of hDPP III [3-6], as well as the results of the ongoing experimental research on the Keap1-hDPP III interaction will be presented. Namely, there is a clear evidence that DPP III is involved in the cytoprotective Keap1/Nrf2 pathway, most probably by binding to Keap1 in the oxidative stress conditions [1]. As a result, Nrf2 function is enhanced leading to the overexpression of the cytoprotective genes [2].

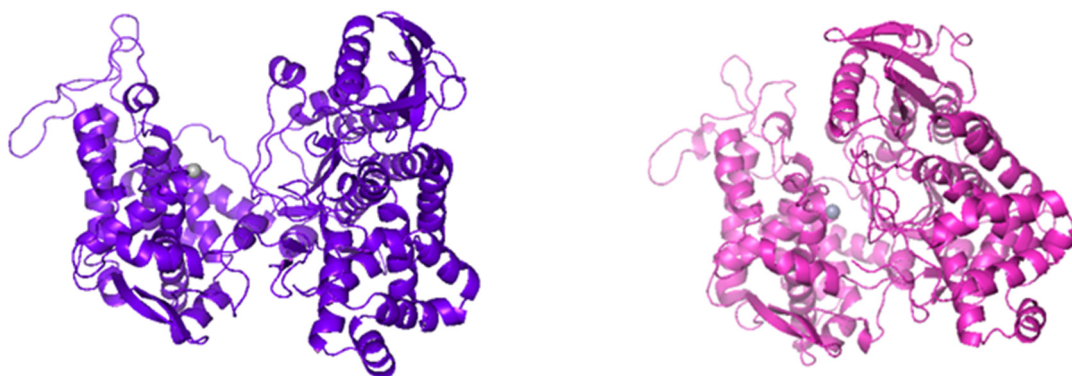

Figure 1: hDPP III in its open (violet) and closed (magenta) form. Zinc ion is represented as gray sphere.

References

- [1] B. E. Hast, D. Goldfarb, K. M. Mulvaney, M. A. Hast, P. F. Siesser, F. Yan, D. N. Hayes and M. B. Major, *Cancer Res.* **73** (2013) 2199-2210.
- [2] K. Lu, A. L. Alcivar, J. Ma, T. K. Foo, S. Zywea and A. Mahdi, *Cancer Res.* **77** (2017) 2881-2892.
- [3] A. Tomić, M. González and S. Tomić, *J. Chem. Inf. Model.* **52** (2012) 1583-1594.
- [4] A. Tomić and S. Tomić, *Dalt. Trans.* **43** (2014) 15503-15514.
- [5] A. Tomić, M. Berynsky, R. C. Wade and S. Tomić, *Mol. Biosyst.* **11** (2015) 3068-3080.
- [6] A. Tomić, B. Kovačević and S. Tomić, *Phys. Chem. Chem. Phys.* **18** (2016) 27245-27256.

Monitoring trace organic contaminants in water treatment processes – from target analysis, suspect screening to non target analysis
Praćenje tragova organskih zagađivala tijekom procesa obrade voda – od ciljane i pretražne do sveobuhvatne analize

Mira Petrović^{1,2} Yaroslav Verkh,¹ Mira Celic,¹ Meritxell Gros¹

¹ICRA – Catalan Institute for Water Research, Girona, Spain

²ICREA – Catalan Institution for Research and Advanced Studies, Barcelona, Spain

E-mail: mpetrovic@icra.cat

Wastewater dissolved organic matter (DOM) represents a complex, heterogenic mixture of polysaccharides, proteins, lipids, nucleic acids, soluble microbial products, and anthropogenic organic chemicals. Among these chemicals, the complement of anthropogenic substances used by humans and effectually disposed of in wastewater encompasses thousands of compounds. It includes, among others, surfactants, personal care products, pharmaceuticals, biocides, pesticides, and industrial chemicals. Additionally, there is a wide range of biologically active transformation products (TPs), intermediates, metabolites, and tertiary treatment disinfection by-products (DBPs). Some of these compounds can be hazardous even at a low concentration and the confirmed discharge of micro-contaminants into groundwater and water bodies for indirect potable reuse puts the end-consumer at risk.

Despite many methodologies being developed to detect environmental contaminants in wastewater, the detection of thousands potentially dangerous DOM constituents and their transformation in wastewater treatment remains a challenge. Among methods applied is mass spectrometry (MS) with distinctive ability to identify small amounts of organic chemicals from increasingly complex mixtures providing therefore a large amount of information on wastewater DOM and micro-contaminants of interest within.

This paper will discuss three main groups of workflows using liquid chromatography (LC) coupled to low and high resolution MS that broadly separate into targeted, suspect, and non-targeted screenings. Nowadays, non-targeted analysis drives the exploration of DOM transformation in wastewater gradually displacing the interest in targeted methods in the researcher community.

Acknowledgment: This work has been supported by the EU H2020 research and innovation programme under the Marie Skłodowska-Curie grant agreement No 812880 – NOWELTIES ITN-EJD project. Authors also acknowledge the support from the Economy and Knowledge Department of the Catalan Government through Consolidated Research Group (ICRA-ENV 2017 SGR 1124).

Natural zeolites in environmental protection Prirodni zeoliti u zaštiti okoliša

Marina Trgo

Kemijsko-tehnološki fakultet Sveučilišta u Splitu, Split, Hrvatska

E-pošta: mtrgo@ktf-split.hr

Prirodni zeoliti su alumosilikatni minerali koji imaju sposobnost sorpcije i izmjene iona. Zbog tih svojstava nalaze široku primjenu u industriji, zaštiti okoliša, poljoprivredi, stočarstvu i farmaciji. Novija znanstvena istraživanja usmjerena kemijskoj i tribomehaničkoj modifikaciji prirodnih zeolita dala su izuzetne rezultate povećanja kapaciteta sorpcije i nove mogućnosti njihove primjene u svim segmentima zaštite okoliša. Tako se mogu uspješno koristiti za selektivno pročišćavanje dimnih plinova, otpadnih voda, remedijaciju tla i sorpciju radioaktivnih iona. Novija istraživanja na Kemijsko-tehnološkom fakultetu u Splitu pokazala su uspješnu primjenu prirodnog i modificiranog zeolita u vezanju teških metala iz vodenih otopina, obradi procjednih voda odlagališta otpada te vezanju žive iz onečišćenog tla. Rezultati eksperimenata provedenih šaržnim i/ili postupkom u koloni s nepokretnim slojem pokazali su uspješno vezanje iona teških metala, Zn, Pb, Cd, Ni, Mn te smanjenje koncentracije fosfata i nitrata. Ispitivanja pri različitim visinama sloja, protocima i početnim koncentracijama iona metala u otopinama dala su uvid u mehanizme prijenosa tvari u ovim sustavima, omogućila matematički opis korištenjem različitih modela kao i predviđanje ponašanja pri drugim uvjetima eksperimenta. Modeliranjem je omogućena procjena primjene permeabilnih reaktivnih barijera sačinjenih od zeolita s ciljem prevencije onečišćenja podzemnih voda teškim metalima. Istraživanja u realnim sustavima velik su izazov u primjeni zeolita, gdje su se pokazali kao vrlo dobar sorbent u obradi procjedne vode onečišćene živom i procjedne vode odlagališta otpada.

Lab-automation – showcases from the chemistry-biology interface Automatizacija u laboratoriju – primjeri s granice između kemije i biologije

Marko D. Mihovilovic

TU Wien, Institute of Applied Synthetic Chemistry, Vienna, Austria

E-mail: marko.mihovilovic@tuwien.ac.at

Technological advances of the past two decades have revolutionized work-processes in chemistry laboratories. With the advent of instrument-assisted synthesis the output of synthetic chemists can be substantially increased with respect to compound numbers and speed of process optimization.

Several showcases will be discussed outlining the impact of microwave assisted synthesis and flow-chemistry for the generation of compound libraries as well as for scaling-up of chemical processes from milligram to multi-gram scale [1]. Particular emphasis will be put on case studies at the chemistry-biology interface, *e.g.* from computational chemistry, chemo-enzymatic catalysis, and sustainable chemistry [2].



References

- [1] M. Schön, M. Schnürch and M. D. Mihovilovic, *Mol. Divers.* **15** (2011) 639-643; M. J. Fink, M. Schön, F. Rudroff, M. Schnürch and M. D. Mihovilovic, *ChemCatChem* **5** (2013) 724-727; M. Schön, D. Dreier, D. M. Schnürch and M. D. Mihovilovic, *Monatsh. Chem.* **147** (2016) 523-532.
- [2] F. Rudroff, M. D. Mihovilovic, H. Gröger, R. Snajdrova, H. Iding and U. T. Bornscheuer, *Nat. Catal.* **1** (2018) 12-22.

Supercritical CO₂ extraction of plant biologically active compounds Superkrična CO₂ ekstrakcija bioaktivnih komponenti iz biljnog materijala

Stela Jokić

Josip Juraj Strossmayer University of Osijek, Faculty of Food Technology, Osijek, Croatia

E-mail: stela.jokic@ptfos.hr

Recent trends in the extraction techniques have largely focused on finding solutions that minimize the use of harmful solvents and allow the use of alternative, so called “green” solvents that ensure safe and high quality extracts. Supercritical fluid extraction (SFE) emerged in the last few decades as a promising green technology and a good alternative in food and natural products processing. By using carbon dioxide (CO₂) as a solvent, the SFE becomes environmentally friendly process resulting in solvent-free extracts/without any trace of toxic solvents, and are thereby highly valued [1].

Today, SFE is not only used in laboratories, namely, it is, even more often, also used on a large scale for a lot of industrial applications. During the SFE it is very important to understand the effects of the different parameters on the yield and extract quality. The knowledge of these effects is not only useful for the optimization and economic evaluation of the process, but also for the ability to predict the extraction process, which is useful for *scale-up* as well as for the design and the optimization of future industrial plants [2].

SFE has a wide application area and is capable of extracting a wide range of diverse compounds from variety of raw material matrices. A brief overview of the up to date knowledge regarding supercritical fluids will be presented, with special emphasis on the design and development of SFE laboratory plant and *scale-up* criteria for SFE. The selected examples of the extraction of plant biologically active compounds by supercritical CO₂ will be presented.

References

- [1] M. Cvjetko Bubalo, S. Vidović, I. Radojčić Redovniković and S. Jokić, *Food Bioprod. Process.* **109** (2018) 52-73.
- [2] S. Jokić, G. Horvat and K. Aladić, *Design of SFE system using a holistic approach – problems and challenges*, in: J. Lindy (Ed.) *Supercritical Fluid Extraction: Technology, Applications and Limitations*, Nova Science Publishers, Inc., 2015, NY, USA, pp. 95-122.

Marine worms as a source of unexpected chemical diversity Morski crvi kao iznenađujući izvor kemijske raznolikosti

Olivier P. Thomas, Kevin Calabro, Perrine Lasserre
Marine Biodiscovery, NUI Galway, Galway, Ireland

E-mail: olivier.thomas@nuigalway.ie

With the support of the Marine Institute in Ireland we have set up a national laboratory for marine biodiscovery. We will first present the functioning of the marine repository which principal objective is the discovery of new products and new applications of marine natural products from Irish marine invertebrates.

After a chemical screening of the fractions stored in the repository, a deep chemical investigation was undertaken on an unstudied intertidal worm *Eupolyornia nebulosa*. After a series of HPLC purifications we were able to unveil a large diversity of sulfur-containing amino acids. We will describe the structure elucidations of these metabolites with a focus on the relative and absolute configurations and possible metabolic pathway.

These promising findings should prompt the inclusion of marine worms in the marine biodiscovery pipeline. Therefore, the marine environment can still be considered an untapped reservoir of chemical diversity even through the exploration of largely accessible marine species.

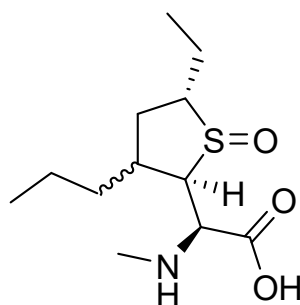

Figure 1: Structure of one sulfur-containing amino acid from the worm *Eupolyornia nebulosa*.

On-surface orientation and reactivity of diamondoid compounds Površinska orijentacija i reaktivnost dijamantoidnih spojeva

Marina Šekutor

Department of Organic Chemistry and Biochemistry, Ruđer Bošković Institute, Zagreb, Croatia

E-mail: msekutor@irb.hr

Diamondoids are naturally occurring cage hydrocarbons consisting of fused cyclohexane rings, with their smallest representative being adamantane [1,2]. Their notable properties include conformational rigidity, thermal stability and low ring strain. Selective functionalization of diamondoids enables their application in medicine, nanotechnology, microelectronics and in development of new carbon-based materials [1,2].

Diamondoids are also of use as dispersion energy donors due to their bulkiness and we found that London dispersion interactions between the cages enable precise self-assembly of diamondoid molecular layers on metal surfaces [3]. Furthermore, we were able to identify the absolute configuration of single chiral diamondoid molecules deposited on a copper surface solely by means of direct visual inspection [4]. In our studies we primarily used high resolution scanning tunneling microscopy (STM) and atomic force microscopy (ATM) in combination with computational tools in order to fully describe our chosen systems and reliably verify the findings.

In addition to studying self-assembly and on-surface orientation of bulky diamondoids that formed ordered 2D lattices, we also explored reactivity of diamondoid derivatives on metal surfaces upon thermal annealing [5]. Using a chemically well-controlled approach, we succeeded in building diamondoid chains that consisted of single Cu atoms suspended by the diamondane framework (Figure 1). The implications of such one-dimensional copper nanowires are of significance in the field of nanotechnology since noble metal chains are expected to be near perfect one-dimensional conductors.

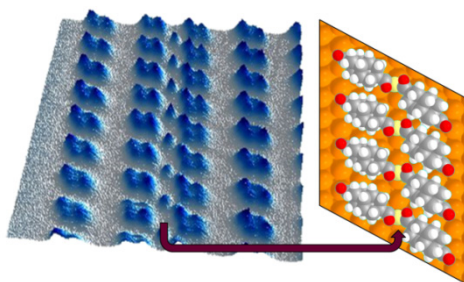

Figure 1: Chains of dehydroxylated 4,9-diamantane dicarboxylic acid molecules with Cu atoms in the middle.

References

- [1] H. Schwertfeger, A. A. Fokin and P. R. Schreiner, *Angew. Chem. Int. Ed.* **47** (2008) 1022-1036.
- [2] M. A. Gunawan, J.-C. Hierso, D. Poinso, A. A. Fokin, N. A. Fokina, B. A. Tkachenko and P. R. Schreiner, *New J. Chem.* **38** (2014) 28-41.
- [3] D. Ebeling, M. Šekutor, M. Stieffermann, J. Tschakert, J. E. P. Dahl, R. M. K. Carlson, A. Schirmeisen and P. R. Schreiner, *ACS Nano* **11** (2017) 9459-9466.
- [4] D. Ebeling, M. Šekutor, M. Stieffermann, J. Tschakert, J. E. P. Dahl, R. M. K. Carlson, A. Schirmeisen and P. R. Schreiner, *Nat. Commun.* **9** (2018) 2420.
- [5] H.-Y. Gao, M. Šekutor, L. Liu, A. Timmer, H. Schreyer, H. Mönig, S. Amirjalayer, N. A. Fokina, A. Studer, P. R. Schreiner and H. Fuchs, *J. Am. Chem. Soc.* **141** (2019) 315-322.

Mechanochemistry and green chemistry – thinking about chemistry in a different way

Mehanokemija i zelena kemija – drugačiji pristup kemiji

Tomislav Friščić

Department of Chemistry, McGill University, Montreal, Canada

E-pošta: tomislav.friscic@mcgill.ca

U posljednjih 20-ak godina, sve jasniji utjecaj različitih grana kemijske industrije na okoliš, te sve veći problemi pristupu prirodnim resursima potaknuli su razvoj istraživanja u kemijskoj sintezi koja nisu usmjerena samo na pripremu novih materijala i molekularnih struktura, nego i na takozvanu „zelenu kemiju“, tj. razvoju sintetskih strategija i eksperimentalnih protokola koji su jednostavniji, čišći (tj. odgovorniji prema okolišu), a u isto vrijeme učinkovitiji u iskorištavanju polaznih materijala [1]. Jedno od najaktivnijih područja u razvoju zelenih metoda sinteze je mehanokemija [2], tj. pristup kemijskoj sintezi i sintezi materijala primjenom mehaničke energije. Za razliku od drugih alternativnih metoda kemijske sinteze, npr. sonokemije ili mikrovalne sinteze, mehanokemija omogućava provedbu raznoraznih transformacija bez upotrebe otapala. Iz tog je razloga mehanokemija prepoznata kao možda čak idealna forma kemijske sinteze [3], jer se njome izbjegava upotreba otapala koja u kemijskim reakcijama u otopini obično sačinjavaju 90 – 95 % reakcijske mase te su godišnje na svjetskom nivou uzrokom generiranja više od 40 milijuna tona kemijskog otpada. Ovo će kratko predavanje pružiti uvod u polje mehanokemije, ilustrirati nove mogućnosti koje mehanokemija pruža za sintezu materijala i molekula, te nove tipove reakcija koje mehanokemija omogućava. Pri tome će naglasak predavanja biti u načinu na koji mehanokemija znanstvenicima i studentima pruža mogućnost propitivanja osnovnih pristupa kemiji, te na prikazu načina na koji se mehanokemija i bezotopinska kemija mogu integrirati u dodiplomsku nastavu.

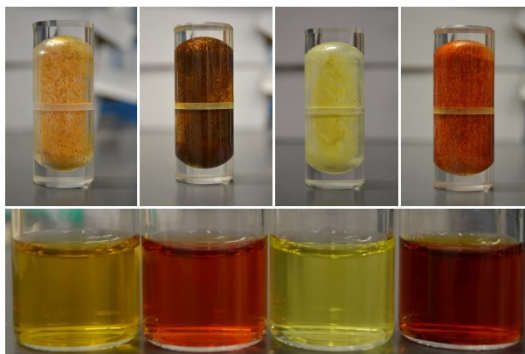

Slika 1: Prikaz primjene mehanokemije u zelenoj kemiji: izbjegavanje opasnih otapala poput zlatotopke u procesiranju plemenitih metala u materijale (gore) topljive u vodi (dolje) [4].

Reference

- [1] P. A. Julien, C. Mottillo i T. Friščić, *Green Chemistry* **19** (2017) 2729-2747.
- [2] J.-L. Do i T. Friščić, *ACS Central Science* **3** (2017) 13-19.
- [3] J.-L. Do i T. Friščić, *Synlett* **28** (2017) 2066-2092.
- [4] J.-L. Do, D. Tan i T. Friščić, *Angew. Chem. Int. Ed.* **57** (2018) 2667-2671.

Integrated chemistry problems in the class, at the competition and final examination

Integrirani zadaci iz kemije u školi, na natjecanju i na državnoj maturi

Tajana Preočanin

Kemijski odsjek, Prirodoslovno-matematički fakultet, Zagreb, Hrvatska

E-pošta: tajana@chem.pmf.hr

Sadržaji u nastavi Kemije navedeni su u nacionalnom kurikulumu [1]. Ishodi koji se propituju na ispitima državne mature propisani su Katalogom državne mature [2]. Kako poučavati kemiju upućuju metodički priručnici [3]. Kako pripremiti učenika za natjecanje iz kemije najčešće je iskustvena odluka samog nastavnika. Nastavnicima i učenicima dostupni su brojni udžbenici, radni materijali, digitalni obrazovni sadržaji i više ili manje opremljeni razredi za izvođenje pokusa. Kojim putem krenuti i kako se nositi s trenutnom situacijom te nametnutim promjenama i zahtjevima na leđima je nastavnika. Od nastavnika se traži da obradi sve sadržaje, pripremi učenike za život, maturu i daljnje školovanje i to u određenom i ponekad prekratkom vremenskom roku.

Zadaci koji povezuju različite kemijske koncepte i objedinjuju više ishoda učenja štede vrijeme i omogućavaju učeniku brže učenje i trajnije znanje. Učeniku se predstavlja problem i kroz zapažanja dolazi do modela i kemijskih zakonitosti. S malo pribora i dostupnih kemikalija moguće je osmisлити jednostavne pokuse koji objedinjuju više koncepata.

Kao primjer osmišljen je i isproban jednostavan pokus otapanja kalcita u klorovodičnoj kiselini:



kojim se objedinjuju znanja vezana uz stehiometriju i brzinu kemijske reakcije, određivanje mjerodavnog reaktanta, te uspostavljanje ravnotežnog stanja. Tijekom otapanja mjeri se masa kalcita, promjena ukupne mase sustava uslijed oslobađanja ugljikova(IV) oksida i/ili koncentracija klorovodične kiseline. Iz izmjerenih masa računaju se množine sudionika reakcije. Iz prikaza vremenske ovisnosti množina određuju se stehiometrijski koeficijenti te prosječna brzina otapanja kalcita. Ovisno o brzini reakcije, raspravlja se o obliku krivulje i završetku reakcije. Zapažanjem i analizom rezultata pokusa mogu biti provjerene usvojenosti više ishoda učenja i na različitim kognitivnim razinama i težinama. Ovu je kemijsku reakciju lako staviti u kontekst svakodnevnog života prikazom primjera procesa koji se događaju u okolišu, kućanstvu ili pri proizvodnji.

Predstavit će se primjeri integriranih zadataka primjenjivih na nastavi Kemije, problemskih zadataka za pripreme učenika za natjecanja iz Kemije i prirodoslovlja, zadataka na ispitu državne mature iz Kemije, te najčešće pogreške pri sastavljanju i rješavanju zadataka.

Reference

[1] Prijedlog predmetnog kurikuluma Kemija, Ministarstvo znanosti i obrazovanja, studeni 2018.

[2] Ispitni katalog za državnu maturu Kemija, šk. god. 2018./19., Nacionalni centar za vanjsko vrednovanje obrazovanja.

[3] M. Sikirica, Metodika nastave kemije, Školska knjiga, 2003.

USMENA PRIOPĆENJA

ORAL PRESENTATIONS

Thermodynamics of polytetrafluoroethylene/aqueous electrolyte solution interface

Termodinamika procesa na međupovršini politetrafluoroetilen/vodena otopina elektrolita

Antun Barišić,¹ Johannes Lutzenkirchen,² Gregory Lefevre,³ Tajana Preočanin¹

¹Department of Chemistry, Faculty of Science, Zagreb, Croatia

²Institute for Nuclear Disposal, Karlsruhe Institute of Technology, Karlsruhe, Germany

³Chemistry ParisTech – CNRS, PSL Research University, Paris, France

E-mail: abarasic@chem.pmf.hr

Polytetrafluoroethylene (PTFE) is an example of a highly hydrophobic material which does not bear surface functional groups and therefore should neither chemically react with water molecules nor with ions from an aqueous electrolyte solution. However, due to the hydrophobicity water dipoles are repelled from the surfaces and orientation of water molecules is less random than in the bulk of the solution. This ordering and distribution of water molecules and ions in the vicinity of the surface cause the formation of an electrical interfacial layer (EIL) [1].

It was found for all hydrophobic materials that the electrophoretic mobility, and thus the surface charge and surface potentials, are pH dependent [2]. The value of isoelectric point was found to be in the acidic region, between pH 2 and 4. The origin of electrical charge at a hydrophobic material/aqueous water solution interface, and pH dependency have been a subject of numerous debates in the recent years and is still not solved [3].

The purpose of this research is to establish a model to evaluate the thermodynamic parameters for surface charging of hydrophobic materials. In this respect, the enthalpy of surface reactions was directly determined by means of calorimetric experiments and indirectly by measuring the temperature dependence of the electroneutrality point by potentiometric mass titration and streaming current measurements.

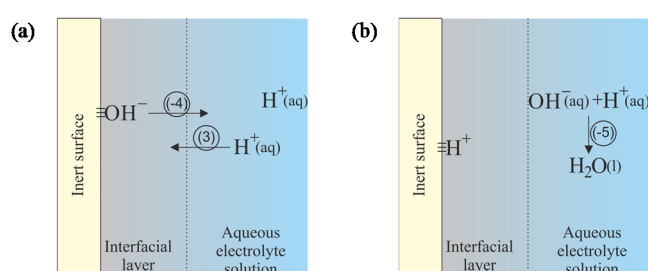

Figure 1: Exchange of H^+ and OH^- ions between interfacial layer and bulk of the solution and dissociation of water molecule in the bulk of the aqueous electrolyte solution.

References

- [1] T. Preočanin, A. Selmani, P. Lindqvist-Reis, F. Heberling, N. Kallay and J. Lützenkirchen, *Colloids Surf. A Physicochem. Eng. Asp.* **412** (2012) 120-128.
- [2] T. W. Healy and D. W. Fuerstenau, *J. Colloid Interface Sci.* **309** (2007) 183-188.
- [3] N. Kallay, F. Šupljika and T. Preočanin, *Adsorption* **19** (2013) 211.

Acknowledgment: This research was supported by the Croatian Science Foundation under the project IP-2014-09-6972.

Computational and experimental characterization of adenylosuccinate synthetase from *Helicobacter pylori*
Računalna i eksperimentalna karakterizacija adenilosukcinat-sintetaze iz *Helicobacter pylori*

Ante Bubić¹, Branimir Bertoša,² Ivana Lešćić Ašler,¹ Marija Luić¹

¹*Institute Ruđer Bošković, Zagreb, Croatia*

²*Faculty of Science, University of Zagreb, Croatia*

E-mail: abubic@irb.hr

Helicobacter pylori is a Gram-negative microaerophilic bacterium that chronically colonizes the gastric epithelium. Presence of these bacteria in humans can lead to the development of several gastrointestinal diseases, including non-symptomatic chronic gastritis, peptic ulcer disease, gastric mucosa-associated lymphoid tissue (MALT) lymphoma, and gastric adenocarcinoma [1].

Adenylosuccinate synthetase (ADSS) is one of the key enzymes in purine salvage pathway, which catalyses condensation reaction of IMP with L-aspartate (ASP) to form adenylosuccinate by GTP hydrolysis in the presence of Mg²⁺ ions. Bioinformatic studies showed that *H. pylori* lacks the genes for *de novo* synthesis of purines. Consequently, the viability of *H. pylori* relies on salvage pathway for purine synthesis. Thus, ADSS represents a potential drug target for *H. pylori* infection [2,3].

Using experimental methods, such as enzyme kinetics, we have successfully determined main kinetic parameters for all three substrates (ASP, GTP, IMP). Additionally, inhibition tests were done with known inhibitor (hadacidin) and with adenylosuccinate (main reaction's product). Preliminary binding experiments were conducted for all three substrates using microscale thermophoresis, in order to obtain binding parameters. Since attempts to solve 3D-structure of ADSS using crystallography were unsuccessful as yet, homology modelling was applied to obtain 3D-model. The model was constructed using multisequence alignment based on six closely related protein structures of ADSS. Using obtained 3D model, several systems of ADSS enzyme alone, as well as in complex with different ligands, including substrates and inhibitors, were prepared for molecular dynamics (MD) simulations at the temperature of 310 K. The aim of this research is to decipher the mechanism of ADSS enzyme, with the final goal of designing new inhibitors.

References

- [1] S. Nishiumi, M. Yoshida and T. Azuma, *Microb. Pathog.* **109** (2017) 78-85.
- [2] K. Eaazhisai, R. Jayalakshmi, P. Gayathri, R. P. Anand, K. Sumathy, H. Balaram and M. R. N. Murthy, *J. Mol. Biol.* **335** (2004) 1251-1264.
- [3] G. Liechti and J. B. Goldberg, *J. Bacteriol.* **194** (2011) 839-854.

Analysis of glycerol binding within the active site of B₁₂-dependent diol dehydratase; implications for catalysis and inhibition

Analiza vezanja glicerola u aktivnom mjestu B₁₂-ovisne diol dehidrataze; implikacije na katalizu i inhibiciju

Luka Bilić, Danijela Barić, Radha Dilip Banhatti, David M. Smith, Borislav Kovačević
Ruđer Bošković Institute, Zagreb, Croatia

E-mail: lbilic@irb.hr

Microbial conversion of crude glycerol, the waste from biofuel production, into compounds of greater industrial value could solve technical difficulties encountered by the conventional means of chemical conversion [1]. During the particular type of microbial conversion, in the first step glycerol undergoes dehydration by enzymes dehydratases into 3-hydroxypropionaldehyde (3HPA) [2,3]. Two classes of dehydratases can catalyze dehydration of glycerol, B₁₂-independent and B₁₂-dependent dehydratases, from which B₁₂-dependent class is more often used due to its tolerance to aerobic conditions [4]. However, a peculiar property of B₁₂-dependent dehydratases is that glycerol, which is their substrate, also acts as an irreversible inhibitor [5]. Based on the B₁₂-dependent diol dehydratase (B₁₂-dDDH) crystal structure with glycerol (PDB code: 3AUJ), K. Yoshizawa *et al.* concluded that the geometry of such bound glycerol enables radical reorganization thus causing inhibition. [6] However, in the recent study on similar enzyme B₁₂-dependent glycerol dehydratase we observed glycerol in a different geometry [7]. Here we present a detailed computational study of glycerol binding within the active site of B₁₂-dDDH and find a binding geometry similar to one observed in Ref. 7 (Figure 1). We consider larger implications of our findings for the mechanism of substrate induced inactivation.

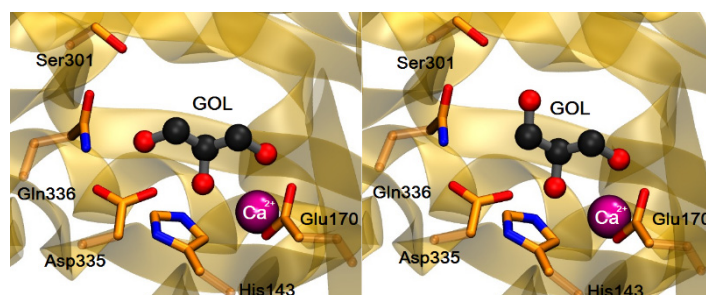

Figure 1: Two different binding geometries of substrate glycerol in the active site of B₁₂-dDDH.

References

- [1] Z. Chen and D. Liu, *Biotechnol. Biofuels* **9** (2016) 205.
- [2] T. Toraya, *Cell. Mol. Life Sci.* **57** (2000) 106-127.
- [3] T. Toraya, *Chem. Rev.* **103** (2003) 2095-2127.
- [4] W. Jiang, S. Wang, Y. Wang and B. Fang, *Biotechnol. Biofuels* **9** (2016) 57.
- [5] W. W. Bachovchin, J. R. G. Eagar, K. W. Moore and J. H. Richards, *Biochemistry* **16** (1977) 1082-1092.
- [6] K. Doitomi, T. Kamachi, T. Toraya and K. Yoshizawa, *Biochemistry* **51** (2012) 9202-9210.
- [7] B. Kovačević, D. Barić, D. Babić, L. Bilić, M. Hanževački, G. M. Sandala, L. Radom and D. M. Smith, *J. Am. Chem. Soc.* **140** (2018) 8487-8496.

Mechanochemical synthesis of graphene oxide with variable degree of oxidation

Mehanokemijska sinteza grafenova oksida ugodivog stupnja oksidacije

Magdalena Kralj, Irena Sović, Ivan Halasz
Ruđer Bošković Institute, Zagreb, Croatia

E-mail: mkralj@irb.hr

Graphene oxide (GO) is single-atom carbon layer, combination of unsaturated benzene rings and aliphatic heterocycles containing hydrophilic oxygen groups [1].

Lately, GO has attracted significant attention, mostly as a potential material for mass production of graphene, but also for its potential for various other applications such as optical materials [2], electronic and energy storage devices, biosensors [3] and photocatalysts [4]. A great advantage of GO are its tunable physicochemical properties which depend upon the degree of oxidation.

Conventional chemical synthesis of GO mostly prefers the Hummers method. As a result, laboratory- and industrial-scale chemical synthesis of GO are inherently generating toxic waste. It is therefore essential to find greener and potentially also cheaper ways of its production. Here, we report versatile and eco-friendly approach to prepare high quality graphene oxide by use of mechanochemical ball milling of graphite in the presence of KMnO_4 and the stoichiometric amount of sulfuric acid. We have examined how various conditions of mechanochemical synthesis affect GOs degree of oxidation, which we have been able to obtain in the range from 17 % to 62 %.

Prepared materials were characterised by powder X-ray diffraction, Raman spectroscopy, thermogravimetric analysis, FTIR spectroscopy and SEM/EDS microscopy.

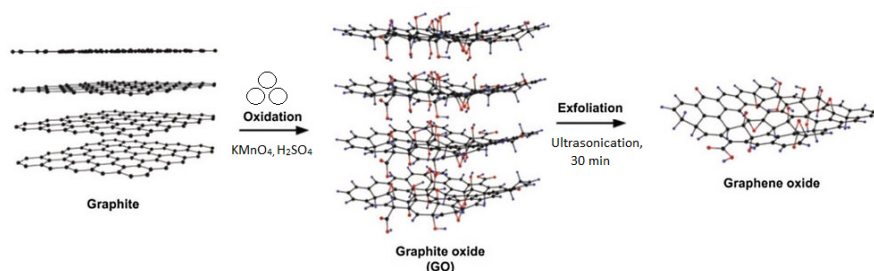

Figure 1: Mechanochemical preparation of graphene oxide.

References

- [1] M. Kralj, Priprava kompozita metalni oksid/grafen i njegova primjena u superkondenzatorima, Diplomski rad, 2017., 5-6.
- [2] M. Acik and S. B. Darling, *J. Mat. Chem. A* (2016) 6185-6235.
- [3] S. C. Ray, *Applications of Graphene and Graphene-Oxide Based Nanomaterials*, A volume in Micro and Nano Technologies, W. Andrew by Elsevier, London, 2015, pp 39-55.
- [4] X. Jiang, J. Nisar, B. Pathak, J. Zhao and R. Ahuja, *J. Catal.* (2013) 204-209.

Acknowledgment: This work was supported by the Ministry of Environment and Energy, the Ministry of Science and Education, the Environmental Protection and Energy Efficiency Fund and the Croatian Science Foundation under the project "New Materials for Energy Storage", in the total amount of 1,962,100 HRK and by the Centre of Excellence for Advanced Materials and Sensing Devices, a project financed by the European Union through the European Regional Development Fund – the Competitiveness and Cohesion Operational Programme (KK.01.1.1.01.0001)

Aggregation paths of poly-3-(hexyl thiophene) in the presence of either [6,6]-phenyl-C61-butyric acid methyl ester or poly(ϵ -caprolactone) Načini agregiranja poly-3-(heksil-tiofena) u prisutnosti metilnog estera [6,6]-fenil-C₆₁-maslačne kiseline ili poli(ϵ -kaprolaktona)

Marta Da Pian,¹ Michele Maggini,¹ G. Julius Vancso,² Edmondo M. Benetti,^{2,3} Valerio Causin¹
¹Dipartimento di Scienze Chimiche, Università di Padova, Padova, Italy
²Mesa+ Institute for Nanotechnology, University of Twente, The Netherlands.
³Department of Materials, ETH Zürich, Zurich, Switzerland

E-mail: valerio.causin@unipd.it

Poly-3-(hexyl thiophene) (P3HT) is currently the benchmark semiconducting polymer for organic photovoltaics. Its physical, electrical, photophysical properties are strongly dependent on its morphology in the solid state. However, several issues remain unclear, regarding the forces that drive the assembly/crystallization of P3HT into fibrillar nanocrystals (NCs) in marginal solvent conditions (anisole) [1,2].

This work reports the results of a systematic study on the aggregation/crystallization behavior of P3HT to NCs under different solution conditions and in the presence of different relative contents of either [6,6]-phenyl-C61-butyric acid methyl ester (PCBM) [3] or poly(ϵ -caprolactone) (PCL) [4]. PCBM and PCL confined the aggregation/crystallization process of P3HT NCs allowing the formation of extended crystallites and influencing the kinetics of their assembly.

This work aims on one hand to contribute to a still underinvestigated field, *i.e.* the control of the crystallization of polymers by a polymer templating matrix. In the literature, there are many reports featuring the polymer-templated preparation of inorganic crystals, but only a few examples of crystallization-driven assembly of functional (polymeric) materials inside an inert polymeric matrix.

On the other hand, this project had the long term applicative aim of merging in a single material, by self-assembly and without complex chemical functionalisations, the conductive properties of P3HT and the biomedical features of PCL. This could lead to devices for controlled tissue regeneration, by targeting cells that communicate through ions flows and enhancing supercellular organization.

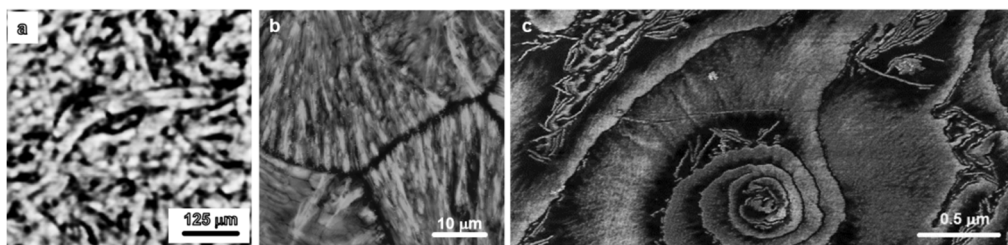

Figure 1: AFM phase micrograph of P3HT NCs mixture obtained from a) P3HT:PCBM 1:1, b) and c) P3HT:PCL 160:1 relative concentrations (w/w).

References

- [1] E. M. Benetti, V. Causin and M. Maggini, *Adv. Mater.* **24** (2012) 5636-5641.
- [2] S. Sun, T. Salim, L. H. Wong, Y. L. Foo, F. Boeya and Y. M. Lam, *J. Mater. Chem.* **21** (2011) 377-386.
- [3] M. Da Pian, M. Maggini, G. J. Vancso, V. Causin, E. M. Benetti *Eur. Polym. J.* **109** (2018) 222-228.
- [4] M. Da Pian, M. Maggini, G. J. Vancso, V. Causin and E.M. Benetti, *Eur. Polym. J.* submitted.

Development of composite Nafion-YSZ membranes with improved stability for drastic conditions in polymer electrolyte fuel cells

Razvoj kompozitnih membrana od Nafiona i YSZ-zeolita poboljšane stabilnosti za drastične uvjete u gorivim ćelijama s polimernim elektrolitom

Ada Saccà, Alessandra Carbone, Rolando Pedicini, Irene Gatto, Enza Passalacqua
 CNR – ITAE, Institute for Advanced Energy Technologies “Nicola Giordano”, Messina, Italy

E-mail: ada.sacca@itae.cnr.it

Fillers based on yttria-stabilized zirconium oxide (YSZ) have been extensively studied for composite membranes development in polymer electrolyte fuel cells (PEFCs); in particular 8 mol. % content of Y₂O₃ [1] permits to operate at higher *T* and reduced relative humidities. On the basis of a previous study [2,3], cubic ZrO₂ was synthesised using pure ZrO₂ [4] and C-Y₂O₃ as cubic phase inductor. YSZ fillers with varying Y₂O₃ loadings (4.8, 8, 12, 15 mol. %) were synthesised to verify the doping influence on membranes characteristics. Such fillers were used to prepare composite-based Nafion membranes with an optimised filler content (5 wt. %) [2] and casting procedure [5]: NYSZ4.8, NYSZ8, NYSZ12, NYSZ15. Pure Nafion (Nrecast) was used as reference. The chemical-physical characterisation of membranes was performed (water retention, IEC, BET, XRD, TG, DMA, SEM) [3]. Also, Fenton’s test of the oxidative stability was performed in accordance with the design-of-experiments, verifying the filler ability to protect the membranes against degradation. Proton conductivity (PC) at reduced relative humidity and the electrochemical performance (current-voltage curves, accelerated degradation test – ADT, H₂ crossover) in drastic conditions were studied. For ADT, the samples were stressed between 0.1 and 0.4 A cm⁻² up to the failure or significant performance decrease. PC at reduced RH supplied high values at *T*_c = 100 – 120 °C for films with the highest Y₂O₃ loads (12 – 15 mol. %) confirming intrinsic YSZ proton conductivity. The composite membranes proved to be more resistant in terms of oxidative stability, provided higher durability and cycle number increase (119 vs. 95 cycles in ADT) with reduced H₂ crossover (H₂-CrO). NYSZ12 sample seems to represent the best candidate for final application due to its durability in terms of design-of-experiments targets – H₂ crossover (EoT). Table 1 presents the main results.

Table 1: Main ADT and H₂ crossover results.

Membrane	Cycle nr.	H ₂ -CrO, ml _{H2} /sec cm ² Beginning-of-Test	H ₂ -CrO, ml _{H2} /sec cm ² End-of-Test	H ₂ -CrO, mA/cm ² Beginning-of-Life	H ₂ -CrO, mA/cm ² End-of-Life
Nrecast	95	1,93E-04	1,14E-02	1,66	97,78
NYSZ4.8	121	1,63E-04	1,95E-03	1,40	16,80
NYSZ8	58	1,93E-04	1,36E-03	1,66	11,78
NYSZ12	119	1,86E-04	8,32E-04	1,60	2,50
NYSZ15	114	1,62E-04	3,49E-04	1,40	3,00

References

- [1] T. Weissbach, T. J. Peckham and S. Holdcroft, *J. Membr. Sci.* **498** (2016) 94-104.
- [2] A. Saccà, A. Carbone, I. Gatto, R. Pedicini and E. Passalacqua, *Polym. Test.* **65** (2018) 322-330.
- [3] A. Saccà, A. Carbone, I. Gatto, A. K. Sahu, S. D. Bhat and E. Passalacqua, ANM2017 Aveiro, Portugal, July 2017.
- [4] N. A. Comelli, L. M. Grzona, O. Masini, E. N. Ponzi and. M. I. Ponzi, *J. Chil. Chem. Soc.* **49** (2004) 245-250.
- [5] A. Alvarez et al. *Int. J. Hydrogen Energy* **36** (2011) 14725-14733.

Plasma spectrometry in analysis of metal species sorption on zero-valent iron nanoparticles

Spektrometrija plazme u analizi sorpcije specija metala na neutralnim nanočesticama željeza

Sanda Rončević, Ivan Nemet

Department of Chemistry, Faculty of Science, University of Zagreb, Zagreb, Croatia

E-mail: roncevic@chem.pmf.hr

Analytical applications of engineered nanoparticles are generally focused to utilize produced nanomaterials for preconcentration and extraction procedures [1]. Among variety of produced nanomaterials, the zero-valent iron nanoparticles (nZVI) demonstrated the great potential in sorption and removal of specific hazardous substances from environment [2]. The exceptional properties of iron nanoparticles in removal of heavy metals and organic pollutants from water solutions are durability, corrosion resistance, large surface area, and cost effectiveness. The sorption efficiency of nanomaterials is often determined by imaging of solid particles by SEM or XRD methods, while studies that concern the changes in treated solutions are rarely described.

Inductively coupled plasma optical emission spectrometry (ICP-OES) provides sensitive simultaneous measurements of different emission lines in solutions of complex matrix. Therefore, it was adopted in our study of nZVI application for remediation purposes. Synthesis of nZVI particles was performed by the method of ferric iron reduction using sodium borohydride, along with subsequent functionalization by selected organic compounds. As an example of “green” organic coating reagent, the dipicolinic acid was used. Systematic characterization of bare and coated nZVI was obtained by XRD and SEM studies. The extraction capabilities of both kind of prepared nZVI particles were tested during experiments on model aqueous solutions containing metals, *i.e.* cadmium and chromium species. The concentration of adsorbed and residual metal species was determined by ICP-OES method. The matrix effects of bare and coated nZVI particles, which denotes to coexisted iron that was released from nanoparticles into solution, were also evaluated using ICP-OES method. The sensitive plasma spectrometry measurements of starting and residual metal content showed that functionalization of nZVI particles has improved the removal efficiency of examined species from aqueous solutions. It is also shown that plasma spectrometry offer a new insight into complex mechanisms of reactivity of nanoparticles in solutions.

References

- [1] S. Li, W. Wang, F. Liang and W. Zhang, *J. Hazard. Mat.* **322** (2017) 163-171.
- [2] H. Luo, X. Wang, R. Dai, Y. Liu, X. Jiang, X. Xiong and K. Huang, *Microchem. J.* **133** (2017) 518-523.

The role of plasma spectrometry in archaeometallurgical iron samples profiling

Uloga spektrometrije plazme u profiliranju uzoraka arheometalurškog željeza

Ivan Nemet, Sanda Rončević

Department of Chemistry, Faculty of Science, University of Zagreb, Zagreb, Croatia

E-mail: inemet@chem.pmf.hr

Advanced instrumental analytical methods are adopted as the most helpful tools in the chemical characterization of archaeological artefacts [1]. Notable advantages of atomic spectrometry methods based on inductively coupled plasma source with optical or mass detection (ICP-AES, ICP-MS) lay in reliable and high dimensional quantitative elemental characterization of archaeological materials. In archaeometallurgical studies that are focused on ancient iron production, these methods are beneficial in detection of trace and ultra-trace elements [2]. In this work, the combination of elements detection methods (XRF, ICP-AES, ICP-MS), surface analysis (SEM-EDS), and chemometric methods is presented in analysis of early-iron production artefacts. The samples were randomly collected from stored humps of material that was excavated in Turopolje region, NW Croatia under supervision of Zagreb City Museum. Different kinds of slags and pit furnace remains are analysed on major elements content (Fe, Si, Al, Ca, K, Mg, P, Mn, Ti) to trace constituents (Cu, Cr, Ni, Mo, Pb, V, Zn, Zr, and REE's) [3]. By use of statistical analysis (PCA and HCA) on enlarged set of measured data, the similar features of heterogeneous material become clearly discernible. Three types of slags, namely, iron-rich tap slag, bloom slag, and ceramic-rich slag are successfully recognized. Surface mapping by SEM-EDS, along with elemental signature and performed statistical treatment, enables identification of exception in a set of slag material. Combination of different analytical tools allows identification of unknown sample, which was identified as a non-processed bog iron ore. Moreover, the combination of analytical and statistical methods facilitate recognition of inhomogeneous slag remains from archaeometallurgical production sites. The results are especially valuable for discrimination between numerous mutually similar samples that were scattered at excavation site. The presented results are of great importance in multidisciplinary studies concerning early-iron production in Pannonic area.

References

- [1] H. Portillo, M. C. Zuluaga, L. A. Ortega, A. Alonso-Olazabal, X. Murelaga and A. Martinez-Salcedo, *Microchem. J.* **138** (2018) 246-254.
- [2] E. Blackelock, M. Martionon-Torres, H. A. Veldhuijzen and T. Young, *J. Archaeol. Sci.* **36** (2009) 1745-1757.
- [3] I. Nemet, S. Rončević, A. Bugar, T. Zubin Ferri and L. Pitarević, *J. Anal. Atom. Spectrom.* **33** (2018) 2053-2061.

Is thiocyanate content in seed mustard oils from white, brown and black mustard after conventional and modern extraction techniques Udio izotiocijanata u goruščinu ulju sjemenki bijele, smeđe i crne gorušice nakon klasičnih i modernih tehnika ekstrakcije

Ivana Vrca, Azra Đulović, Franko Burčul, Tea Bilušić, Ivica Blažević
Kemijsko-tehnološki fakultet Sveučilišta u Splitu, Ruđera Boškovića 35, 21 000 Split, Hrvatska

E-pošta: ivrca@ktf-split.hr

Bijela (*Sinapis alba* L.), smeđa (*Brassica juncea* L.) i crna (*Brassica nigra* L.) gorušica spadaju u porodicu Brassicaceae koja je poznata po zastupljenosti glukozinolata. Oštećenjem biljnog tkiva glukozinolati dolaze u kontakt s endogenim enzimom mirozinzom, pri čemu nastupa njihova hidroliza i nastaje niz hlapljivih i biološki aktivnih spojeva od kojih su najpoznatiji izotiocijanati [1]. Izotiocijanati su odgovorni i za karakterističnu aromu gorušice. Glukozinolat karakterističan za bijelu gorušicu je sinalbin (4-hidroksibenzil-glukozinolat) čijom hidrolizom nastaje benzil-izotiocijanat, dok je kod smeđe i crne gorušice glavni glukozinolat sinigrin (alil-glukozinolat) čijom hidrolizom nastaje alil-izotiocijanat [2,3]. Uz lipidnu komponentu koja sačinjava velik dio kemijskog sastava sjemenki gorušice (20 – 30 %), sjemenke sadrže i eterična ulja.

Cilj ovoga istraživanja bio je izolirati hlapljiva ulja iz bijele, smeđe i crne gorušice koristeći klasične tehnike (destilacija u aparaturi po Clevengeru i ekstrakcija nakon autolize) te modernu tehniku ekstrakcije mikrovalovima. Nadalje, cilj rada bio je odrediti iscrpак hlapljivih ulja i udio glavnih spojeva u njima nakon provedenih ekstrakcijskih postupaka uz pomoć plinske kromatografije. Također, u istraživanju je ispitana površinska struktura različitih sjemenki gorušice koristeći tehnike optičke i pretražne elektronske mikroskopije (SEM).

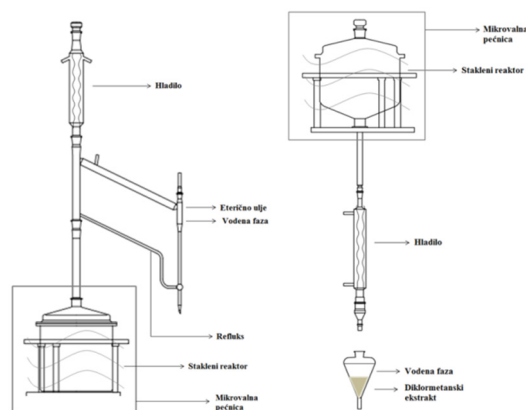

Slika 1: Shema sustava za ekstrakciju potpomognutu mikrovalovima.

Reference

- [1] O. A. Okunade, S. K. Ghawi, L. Methven i K. Niranjana, *Food Chem.* **187** (2015) 485-490.
- [2] S. Herzallah i R. Holley, *LWT-Food Sci. Technol.* **47** (2012) 293-299.
- [3] F. B. Luciano i R. A. Holley, *Int. J. Food Microbiol.* **131** (2009) 240-245.

Explanatory artificial intelligence models for process control in chemical engineering
Objasnidbeni modeli zasnovani na umjetnoj inteligenciji za vođenje procesa u kemijskom inženjerstvu

Želimir Kurtanjek (retired)

Faculty of Food Technology and Biotechnology, University of Zagreb

E-mail: zelimir.kurtanjek@gmail.com

Fourth generation of industrial revolution is based on integrated digital systems of company management, process control and production plants. On the level of production subsystem the main transformation is due to implementation of IoT (internet of things) and robotics. Complex and massive communication leads to Big Data and Artificial Intelligence (AI) based on Machine Learning (ML) dominated by Deep Learning (DL) and Decision Tree (DT) inference. Since AI algorithms are basically nontransparent and at the same time critical for engineer decision-making policies, the explanatory interface between humans and the algorithmic decision models becomes a very important issue. In this work a review of new developments is given, focused on the development of methodologies for transparent reasoning related to human to AI systems to be used in decision making. In this work examples are presented from a standard chemical engineering test control problem of a Tennessee Eastman Kodak production plant. A highly nonlinear two phase catalytic process, exothermal and prone to thermal instabilities is studied. The main objectives of AI aspects of process control are tackled, such as the evaluation of most important process variables, process variable interactions (synergism), global sensitivity and application of decision-tree-based Model Predictive Control (MPC).

References

- [1] B. Efron and T. Hastie, *Computer Age Statistical Inference – Algorithms, Evidence, and Data Science*, Cambridge University Press, New York, 2016.
- [2] D. White, *Chem. Eng. Progr.* **28** (2016) 32-35.
- [3] T. Jockenhovel, L. Biegler and A. Wachter, *Comp. Chem. Eng.* **27** (2003) 1513-1531.
- [4] Ž. Kurtanjek, Systems analysis of ensemble of decision trees for modeling and process control, Proceedings AIChE Annual Meeting, San Francisco, USA, 2016.
- [5] H. Gao, S. Gajjar, M. Kulahci, Q. Zhu and A. Palazoglu, *Ind. Eng. Chem. Res.* **55** (2016) 12046-12059.

Effects of impeller type and presence of baffles on ion exchange in a batch reactor**Utjecaj vrste miješala i razbijala virova na ionsku izmjenu bakra u kotlastom reaktoru**

Anita Bašić, Marija Ćosić, Antonija Čelan, Sandra Svilović
Faculty of Chemistry and Technology, University of Split, Split, Croatia

E-mail: abasic@ktf-split.hr

The aim of this work was to define the influence of hydrodynamic conditions on ion exchange of copper on zeolite NaX in baffled and unbaffled agitated reactor. All experiments were carried out in a batch reactor in which mixing was performed by radial straight blade turbine (SBT) and axial pitched blade turbine (PBT). In baffled reactor four standard baffles were used. At standard impeller off-bottom clearance ($C/H=0.33$), the impeller speeds which ensured complete suspension of zeolite ($N=N_{JS}$) were determined for both impellers used, and applied in further investigations. During all experiments power consumption (P_{JS}) was measured as well. Initial copper concentrations (7.04 mmol L^{-1}) as well as temperatures (300 K) were the same in all experiments. Change of copper concentration over process time was measured by UV/Vis spectrophotometer and used for the calculation of amount of copper exchanged. Various kinetic models were used to test experimental kinetic data.

From the results gained, it was found that the difference in maximum amount of copper exchanged is insignificant and that the reaction is, in general, slightly faster in the baffled reactor. But baffled reactor is characterized by significantly higher power consumption at the same time. On the basis of these findings, the optimal reactor hydrodynamics conditions for copper ion exchange onto NaX zeolite have been suggested.

Impact of millireactor dimensions on conversion of sunflower oil to FAME Utjecaj dimenzija milireaktora na konverziju suncokretova ulja u FAME

Marija Lukić, Domagoj Vrsaljko

University of Zagreb, Faculty of Chemical Engineering and Technology, Zagreb, Hrvatska

E-mail: mlukic@fkit.hr

Company research departments and institutes for chemical engineering have just begun to adopt technologies of additive manufacturing (AM), such as 3D-printing, which they use mostly to make prototypes and produce individual components. One of the examples how AM can be used in chemical industry is producing special types of reactors for continuous production called microreactors. The basic structural unit of the microreactor system is a microchannel which can have a rectangular or circular cross-section, with an area of several μm^2 to several mm^2 . Depending on the diameter of the channel, it is possible to divide reactors into: nano- (1 nm to 100 nm), micro- (100 nm to 1 mm) and milli- (1 mm to 10 mm) reactors. In this paper, an approach for producing simple circular cross-section millireactors through stereolithography (SLA) AM technology is presented. In order to investigate the impact of channel dimensions on conversion of sunflower oil to fatty acid methyl esters (FAME), millireactors with different channel diameters were produced (from 1.5 mm to 3.5 mm). To demonstrate the functionality of the whole system, transesterification reaction of sunflower oil using methanol with addition of KOH base catalyst to FAME was monitored by FTIR, NMR and GC.

Crystalline coordination polymers with flexible response to applied external mechanical force

Kristalni koordinacijski polimeri s fleksibilnim odzivom na primjenu vanjske mehaničke sile

Marijana Đaković, Mateja Pisačić, Nikolina Penić

Department of Chemistry, Faculty of Science, University of Zagreb, Zagreb, Croatia

E-mail: mdjakovic@chem.pmf.hr

Crystals have been perceived for a long time as static, stiff and brittle, and most of all, stationary objects. In addition to a growing number of reports that contradict this traditional way of appreciating crystalline matter where crystals have been found to move, jump, flex or even explode as a response to a number of external stimuli other than mechanical force, [1] mechanical flexibility has recently appeared as a new and highly important addition to this platform. It has so far been observed for only a bunch of organic crystals [2] and a sole single 0-D metal complex [3].

Recently, we have reported on a class of crystalline coordination polymers of cadmium(II) capable of displaying exceptional mechanical elasticity in response to application of external pressure [4]. The structural 1-D spine was decorated with small and rigid heterocyclic ligands bearing halogen functionality adjacent to the heterocyclic nitrogen atom thus forming a supramolecular functionality capable of forming both hydrogen and halogen bonds. It has been shown that slight differences in strengths and geometry of the intermolecular interactions, in a combination with substantial structural interlocking that is orthogonal to the direction of crystal elongation, are critical for *inducing and controlling* the highly unusual mechanical responses of crystalline metal-based polymeric materials.

To fully understand all the structural features necessary for imparting mechanical flexibility to crystalline materials, and thus ensuring their categorization as a promising new class of smart materials, we are reporting on a different family of crystalline coordination polymers with substantial flexible properties. For tailoring the structural spine, here we are employing both cadmium(II) and copper(II) cations, while for tuning non-covalent interactions this time we are using carboxamide moiety.

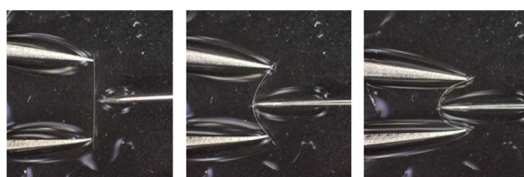

Figure 1: Bending of a needle-shaped crystal of $[\text{CdBr}_2(\text{CONH}_2\text{-pz})_2]_n$.

References

- [1] P. Naumov, S. Chizhik, M. K. Panda, N. K. Nath and E. Boldyreva, *Chem. Rev.* **115** (2015) 12400-12490.
- [2] C. M. Reddy, M. T. Kirchner, R. C. Gundakaram, K. A. Padmanabhan and G. R. Desiraju, *Chem. Eur. J.* **12** (2006) 2222-2234.; S. Ghosh, M. K. Mishra, S. B. Kadambi, U. Ramamurty, G. R. Desiraju, *Angew. Chem. Int. Ed.* **54** (2015) 2674-2678.
- [3] A. Worthy, A. Grosjean, M. C. Pfrunder, Y. Xu, C. Yan, G. Edwards, J. K. Clegg and J. C. McMurtrie, *Nat. Chem.* **10** (2018) 65-69.
- [4] M. Đaković, M. Borovina, M. Pisačić, C. B. Aakeröy, Ž. Soldin, B.-M. Kukovec and I. Kodrin, *Angew. Chem Int. Ed.* **57** (2018) 14801-14805.

On the border between inter- and intramolecular: two-electron multicentric covalent bonding

Na granici između inter- i intramolekulskoga: dvoelektronske multicentrične kovalentne veze

Krešimir Molčanov,¹ Biserka Kojić-Prodić,¹ Vladimir Stilinović,² Zhongyu Mou,³ Miklos Kertesz,³ Bruno Landeros-Rivera,⁴ Jesús Hernández-Trujillo⁴

¹Ruđer Bošković Institute, Zagreb, Croatia

²Faculty of Science, University of Zagreb, Croatia

³Department of Chemistry, Georgetown University, Washington D.C., USA

⁴UNAM Mexico City, Mexico

E-mail: kmolcano@irb.hr

Three model systems with strong interactions bordering intra- and intermolecular were studied by experimental X-ray charge density analysis: hydrogen bonding, halogen interactions and π -stacking. The studies revealed that in all three cases the interaction involves multicentric two-electron covalent bonding.

Nature of the strong hydrogen bond was studied on the well-known protonated dimer of water molecules, the Zundel cation [1]. Our study shows that both O-H bonds in the central O-H-O fragment have a maximum electron density of about $1 \text{ e } \text{Å}^{-3}$, and the negative value of the Laplacian, consistent with 2-electron/3-centre bonding; O-H bonds have an order of 0.5.

Recent studies showed that nature and strength of hydrogen and halogen bonds are similar [2]. We studied two systems with very short and strong halogen bond N-Br \cdots N. Pure *N*-bromosuccinimide was used as a standard, to evaluate charge density of a single N-Br bond. In its co-crystal with 3,5-dimethylpyridine, the Br atom is displaced toward the acceptor by almost 0.4 Å and the maximum electron density in the contact Br \cdots N is $0.4 \text{ e } \text{Å}^{-3}$, indicating a significant covalent contribution. The strongest halogen bond, a symmetrical N-Br-N fragment, was studied in crystals of bromonium salt, bis(3-methylpyridine)bromonium perchlorate and it involves a two-electron/three-centre covalent bond N-Br-N.

Our studies of π -interactions of semiquinone radicals involved three types of stacks: closely interacting radical dimers ('pancake bonding') [3], trimers of partially charged radicals [4] and stacks of equidistant radicals [3]. X-ray charge density supported by quantum chemical modelling revealed considerable covalent contribution (*i.e.* spin coupling and mixing of SOMO orbitals) in all of them. Therefore, π -interactions between the radicals can be regarded as two-electron multicentric covalent bonding.

References

[1] K. Molčanov, C. Jelsch, E. Wenger, J. Stare, A. Ø. Madsen and B. Kojić-Prodić, *CrystEngComm*, **19** (2017) 3898-3901.

[2] V. Stilinović, G. Horvat, T. Hrenar, V. Nemeč and D. Cinčić, *Chem. Eur. J.* **23** (2017) 5244-5257.

[3] K. Molčanov, C. Jelsch, B. Landeros, J. Hernández-Trujillo, E. Wenger, V. Stilinović, B. Kojić-Prodić and C. Escudero-Adan, *Cryst. Growth Des.* **19** (2019) 391-402.

[4] K. Molčanov, Z. Mou, M. Kertesz, B. Kojić-Prodić, D. Stalke, S. Demeshko, A. Šantić and V. Stilinović, *Chem. Eur. J.* **24** (2018) 8292-8297.

Acknowledgment: The work was financed by the Croatian Science Foundation, grant no. IP-2014-09-4079.

Different architectures of oxalate- and chloranilate-bridged heterometallic compounds with 1,10'-phenanthroline
Različite arhitekture heterometalnih spojeva s 1,10-fenantrolinom koji sadrže oksalatne i kloranilatne mostove

Lidija Kanižaj, Krešimir Molčanov, Marijana Jurić
Ruđer Bošković Institute, Zagreb, Croatia

E-mail: lidija.kanizaj@irb.hr

Chemically bonded organic and inorganic hybrid materials, *i.e.*, metal coordination compounds, are a major current research area, which involves their design, synthesis, and potential applications. The adaptable nature of the organic ligands and their variety of coordination modes, together with the geometry of the constitutive metal ions, provide an assortment of topologies and different architectures that can be accomplished by chemical design. In the field of molecular magnetism, coordination polymers have been extensively used to generate molecule-based magnetic materials exhibiting spontaneous magnetization above room temperature, or at least above liquid nitrogen.

Oxalate ion, $C_2O_4^{2-}$, has an important role in design and synthesis of the heteropolynuclear complexes due to its various possibilities of coordination to metal centers and its ability to mediate magnetic interactions between paramagnetic metal ions. For the preparation of extended multifunctional systems, stable mononuclear anionic oxalate complexes as tris(oxalato)metalate anions, $[M^{III}(C_2O_4)_3]^{3-}$ ($M^{III} = Mn, Cr, Fe, V$), are often used as ligands toward another metal ion.

Magnetic properties of oxalate-based compounds can be tuned by acting directly on the exchange pathways within the chains/layers by varying metal centres or modifying the bridging oxalate ligand, as using larger bis(bidentate) bridging ligands, for example dianion of 2,5-dihydroxy-1,4-benzoquinone (H_2dhdq) and its derivatives ($C_6O_4X_2^{2-} = X_2An^{2-}$).

Applying the layering technique and using $K_3[M(C_2O_4)_3] \cdot 3H_2O$ ($M = Cr^{3+}, Fe^{3+}$) or $[(n-Bu)_4N]_3[Cr(Cl_2An)_3]$ as building blocks in reactions with $CuCl_2 \cdot H_2O$ and 1,10'-phenanthroline, the single crystals of heteropolynuclear complexes **1–3** have been formed. Structures of green prismatic crystals of compounds $\{[Cu_3(phen)_3(H_2O)Cr(C_2O_4)_4][Cu(phen)Cr(C_2O_4)_3] \cdot 3H_2O \cdot CH_3CN\}_n$ (**1**) and $\{[Cu_4(phen)_4Fe_2(C_2O_4)_7] \cdot 3H_2O \cdot 3CH_2Cl_2\}_n$ (**2**) consist of one-dimensional (1D) oxalate-bridged chains: cationic $[Cu_3(phen)_3(H_2O)Cr(C_2O_4)_4]_n^{n+}$ and anionic $[Cu(phen)Cr(C_2O_4)_3]_n^{n-}$ in **1** and ladder-like in **2**. Both compounds contain two different bridging modes of the oxalate ligand between different metal centers – bis(bidentate) and mono-bidentate. Using chloranilate building block, black rod-like crystals of dinuclear chloranilate-bridged complex $[(n-Bu)_4N][Cu(H_2O)_2(phen)Cr(Cl_2An)_3] \cdot 7H_2O \cdot 2CH_3CN$ (**3**) are obtained.

The characterization of the new complexes has been accomplished by means of the single crystal X-ray diffraction study, IR spectroscopy, thermal analysis (TG/DTA) and measurements on a SQUID magnetometer.

Seasonal variations of polycyclic aromatic hydrocarbons in PM₁ particle fraction

Sezonske varijacije policikličkih aromatskih ugljikovodika u PM₁ frakciji lebdećih čestica

Ivana Jakovljević, Zdravka Sever Štrukil, Ranka Godec, Gordana Pehnc
Institut za medicinska istraživanja i medicinu rada, Zagreb, Hrvatska

E-pošta: ijakovljevic@imi.hr

Pod pojmom lebdeće čestice ili aerosola podrazumijeva se raspršena tekuća i/ili kruta faza u zraku. Veličina čestica određuje njihovu depoziciju u respiratornom traktu ljudi. Lebdeće čestice aerodinamičkog promjera manjeg od 10 µm (PM₁₀) talože se uglavnom u gornjem dijelu dišnog trakta, sitnije čestice aerodinamičkog promjera manjeg od 2,5 µm (PM_{2,5}) talože se u plućnim alveolama, dok čestice promjera manjeg od 1 µm (PM₁) mogu prodrijeti iz plućnih alveola u krvotok. Dosadašnja istraživanja nisu pridavala veliki interes za PM₁ frakciju lebdećih čestica koja je opasnija za zdravlje ljudi od većih čestica. U ovom istraživanju određena je masena koncentracija policikličkih aromatskih ugljikovodika (PAU) vezanih na PM₁ frakciju lebdećih čestica te je ispitana njihova sezonska varijacija. Uzorkovanje lebdećih čestica provodilo se tijekom 60 dana u hladnom i toplom dijelu godine. Uzorkovanje se provodilo 24-satnim prosisavanjem zraka kroz filter od kvarcnih vlakana, a volumen prosisanog zraka iznosio je ~ 55 m³. Sakupljanje je provođeno u sjevernom stambenom dijelu Zagreba kojeg karakterizira umjerena gustoća prometa i umjerena naseljenost stanovništva. Koncentracija PAU-a određivana je kromatografijom visoke djelotvornosti (HPLC) s fluorescentnim detektorom promjenjivih valnih duljina ekscitacije i emisije. Određivani su fluoranten (Flu), piren (Pir), benzo(a)antracen (BaA), krizen (Kri), benzo(j)fluoranten (BjF), benzo(b)fluoranten (BbF), benzo(k)fluoranten (BkF), benzo(a)piren (BaP), dibenzo(a,h)antracen (DahA), benzo(ghi)perilen (BghiP), indeno(1,2,3-cd)piren (IP). Tijekom hladnijeg razdoblja najniža vrijednost masene koncentracije zabilježena je za DahA (0,200 ng m⁻³), dok je najviša vrijednost zabilježena za BbF (2,263 ng m⁻³). Tijekom toplijeg razdoblja masene koncentracije svih PAU-a bile su znatno niže te je najniža vrijednost zabilježena također za DahA (0,015 ng m⁻³), a najviša za BghiP (0,087 ng m⁻³). Benzo(a)piren (BaP) je najpoznatiji i najviše proučavan spoj iz skupine PAU-a i često se rabi kao indikator prisutnosti PAU-a u hrani i zraku, BaP nije nužno i najzastupljeniji spoj, ali se uvijek javlja kad su prisutni PAU. Srednja vrijednost masenih koncentracija BaP iznosila je 1,698 ng m⁻³ u hladnijem dijelu godine i 0,055 ng m⁻³ u toplijem dijelu godine.

**Biocorona-derived stabilization of silver nanoparticles in artificial seawater
and the effects of nanoparticle size**
**Stabilizacija i učinak veličine nanočestica srebra omotanih biološkim
omotačima u umjetnoj morskoj vodi**

Maja Levak Zorinc,¹ Petra Burić,² Darija Domazet Jurašin,³ Maja Dutour Sikirić,³ Niko Bačić,⁴
Nevenka Mikac,⁴ Florian Meier,⁵ Roland Drexel,⁵ Daniel M. Lyons¹

¹*Ruđer Bošković Institute, Center for Marine Research, Rovinj, Croatia*

²*Juraj Dobrila University in Pula, Department of Natural and Health Sciences, Pula*

³*Ruđer Bošković Institute, Division of Physical Chemistry, Zagreb, Croatia*

⁴*Ruđer Bošković Institute, Division of Marine and Environmental Research, Zagreb, Croatia*

⁵*Postnova Analytics GmbH, Landsberg am Lech, Germany*

E-mail: maja.levak@irb.hr

Silver nanoparticles (AgNP) are finding increasing use in a range of everyday consumer products. Their release into domestic and municipal wastewater streams is thus a potentially new source of silver input into the aquatic environment. Rapid oxidative dissolution of silver nanoparticles has led to the view that any size-related toxicity arising from the nanoparticles themselves will quickly become insignificant. Further, silver nanoparticles arriving from rivers or directly released from coastal or near-coastal urban areas will additionally undergo rapid agglomeration and aggregation processes in estuarine and marine waters due to high salt concentrations or they will be sequestered by organic matter. However, much of the research in this area has investigated the behaviour of pristine silver nanoparticles in aquatic systems which may not be of high environmental relevance. In passing through wastewater streams nanoparticles will develop a corona comprising of a range of biomolecules. It is still poorly addressed how this biocorona alters the chemical identity and modulates the physicochemical behaviour of silver nanoparticles in aqueous environments.

In this direction, the physicochemical behaviour of protein-encapsulated silver nanoparticles in high strength electrolytes, as a proxy for estuarine and marine waters, was investigated. Bovine serum albumin (BSA)-coated AgNP of various diameters (20, 40, 60 and 100 nm) but of constant mass concentration (5 mg L⁻¹) in artificial seawater (salinity S•38) were used to test the stabilising effect of protein in saline waters. Nanoparticle agglomeration was followed by UV-Vis spectroscopy, with a 57% decrease of the surface plasmon resonance for the coated 20 nm nanoparticles over a period of 7 days, while smaller decreases were noted for 60 nm and 100 nm nanoparticles, *i.e.* 31 and 25%, respectively. The hydrodynamic diameters of the coated nanoparticles remained relatively constant over a period of 5 days for 40, 60 and 100 nm AgNPs, while silver ion release ranged from 10 to 35% of the initial silver nanoparticle mass. These data, juxtaposed to silver nanoparticles without a biocorona which undergo immediate agglomeration upon contact with salt water followed by rapid dissolution, clearly show that a biomolecule corona stabilises silver nanoparticles in harsh aqueous matrices over extended periods. This may have important implications for research on silver nanoparticle-derived toxicity in the environment.

Characterization of commercial ceramic ultrafiltration membranes and flux decline study

Karakterizacija komercijalnih keramičkih ultrafiltracijskih membrana i istraživanje pada fluksa

Maja Zebić Avdičević,¹ Krešimir Košutić,² Slaven Dobrović¹

¹*Sveučilište u Zagrebu, Fakultet strojarstva i brodogradnje, Zagreb, Hrvatska*

²*Sveučilište u Zagrebu, Fakultet kemijskog inženjerstva i tehnologije, Zagreb, Hrvatska*

E-pošta: maja.zebic@fsb.hr

Upravljanje vodama koje obuhvaća sustav održivog razvoja vodnih resursa, racionalno i učinkovito korištenje vode sve je neophodnije, a težište je na implementaciji tehnologija za obradu voda kojima se omogućuje njezina ponovna upotreba. Membranske tehnologije su napredne tehnologije koje omogućuju učinkovitu obradu otpadnih voda, te ponovnu primjenu obrađene vode i tvari iz procesa obrade. Najveća prednost membranskih tehnologija je mogućnost proizvodnje produkta odgovarajuće i konstantne kvalitete kao i mogućnost uklanjanja specifičnih onečišćenja, te proizvodnja vode visoke kvalitete.

Primjena membranskog sustava za obradu vode redovito je popraćena u većoj ili manjoj mjeri pojavom blokiranja membrana uslijed prisustva organskih, anorganskih i bioloških tvari u sustavu. Blokiranje površine i pora unutar membrane rezultira smanjenjem njezine permeabilnosti, povećava troškove upravljanja i održavanja sustava, te zahtijeva učestalo fizikalno-kemijsko čišćenje što može dovesti do oštećenja membrane i skraćivanja njezina životnog vijeka. Nominalna granična molarna masa membrane može se odrediti na temelju separacije razrijeđenih otopina koje sadrže nenabijene molekule, a stupanj zadržavanja proporcionalan je njihovoj molarnoj masi.

U ovom radu prikazana je karakterizacija komercijalnih keramičkih membrana različitih veličina pora separacijom otopina polietilen glikola (PEG) i polietilen oksida (PEO) različitih molarnih masa na temelju izmjerenih vrijednosti ukupnog organskog ugljika (TOC) u ulaznoj otopini i permeatu. Eksperimenti su provedeni pomoću laboratorijskog ultrafiltracijskog uređaja s križnim tokom opremljenoga osjetnicima tlaka i temperature, te spojenoga na programabilni logički kontroler. Praćena je promjena fluksa permeata i transmembranskog tlaka (TMP) na temelju kojih je procijenjen utjecaj veličine molekula PEG/PEO na intenzitet blokiranja pora ispitanih membrana i njihovu regeneraciju nakon separacijskog ciklusa.

3-nitro-6-chloro-2,5-dihydroxyquinone (nitrochloranilic acid) – a novel quinoid compound with a great potential for design of coordination polymers
3-nitro-6-kloro-2,5-dihidroksikinon (nitrokloranilna kiselina) – novi kinonski spoj s velikim potencijalom dizajniranja koordinacijskih polimera

Valentina Milašinović, Krešimir Molčanov
Ruđer Bošković Institute, Zagreb, Croatia

E-mail: Valentina.Milasinovic@irb.hr

2,5-dihydroxyquinones (anilic acids) are a class of versatile organic ligands interesting for design of novel coordination polymers and metal-organic frameworks. They are able to coordinate metals in terminal bidentate and bridging (bis)bidentate modes, and are thus able to form coordination polymers of various topologies [1]. The most commonly used ones are unsubstituted 2,5-dihydroxyquinone [2] and its dichloro-analogue, chloranilic acid (3,6-dichloro-2,5-dihydroxyquinone) [3].

Substituents on positions 3 and 6 of the quinoid ring influence electronic structure of the ring through inductive effect, thus enhancing properties such as acidity, electronegativity (the rings may act as electron acceptors), optical properties (colour and possible luminescence) and capability to coordinate metals. The ligands are also able to mediate magnetic exchange interactions [1].

So far, all studied anilic acids were symmetrically substituted (*i.e.* substituents at positions 3 and 6 were identical), and pioneering work with the first asymmetrically substituted analogue, chlorocyananilic acid (3-chloro-6-cyano-2,5-dihydroxyquinone) revealed interesting luminescent properties [4], promising for design of optoelectronic materials. Here we present a novel asymmetrically substituted ligand, nitrochloranilic acid (3-nitro-6-chloro-2,5-dihydroxyquinone, NCA) and first of its transition metal complexes. In a mononuclear complex $(\text{Hpy})_2[\text{Mn}(\text{NCA})_2(\text{H}_2\text{O})_2]$ it behaves as a terminal bidentate ligand, while in 1D coordination polymers $[\text{Mn}_2(\text{NCA})(\text{H}_2\text{O})_5 \cdot 3\text{H}_2\text{O}]_n$, $\{[\text{Co}(\text{NCA})(\text{phen})] \cdot \text{EtOH}\}_n$ and $[\text{Cu}(\text{NCA})(\text{H}_2\text{O})_2]_n \cdot \text{H}_2\text{O}$ it acts as a bridging (bis)bidentate ligand. In the binuclear $[\text{Cu}(\text{NCA})(\text{bpy})]_2$ it bridges two monomeric units $[\text{Cu}(\text{NCA})(\text{bpy})]$ by bonding to Cu atom through its nitro group.

References

- [1] L. Androš Dubraja, K. Molčanov, D. Žilić, B. Kojić-Prodić and E. Wenger, *New J. Chem.* **41** (2017) 6784-6794; M. Jurić, K. Molčanov and B. Kojić-Prodić, *Dalton Trans.* **43** (2014) 7208-7218.
[2] S. Kitagawa and S. Kawata, *Coord. Chem. Rev.* **224** (2002) 11-34.
[3] S. Benmansour, C. Valles-Garcia, P. Gomez-Claramunt, G. Minguez-Espallargas and C. J. Gomez-Garcia, *Inorg. Chem.* **54** (2015) 5410-5418; M. Jurić, K. Molčanov, D. Žilić and B. Kojić-Prodić, *RSC Adv.* **6** (2016) 62785-62796; M. Atzori, F. Pop, P. Auban-Senzier, R. Clerac, E. Canadell, M. L. Mercuri and N. Avarvari, *Inorg. Chem.* **54** (2015) 3643-365; M. Jurić, K. Molčanov and B. Kojić-Prodić, *Dalton Trans.* **42** (2013) 15756-15765.
[4] M. Atzori, F. Artizzu, L. Marchio, D. Loche, A. Caneschi, A. Serpe, P. Deplano, N. Avarvari and M. L. Mercuri, *Dalton Trans.* **44** (2015) 15786-15802.

Acknowledgment: The work was financed by the Croatian Science Foundation, grant no. IP-2014-09-4079.

Structural insights into complexes and polyoxomolybdate salts derived from asymmetric carbohydrazones

Uvid u strukturu kompleksâ i polioksomolibdatâ izvedenih iz asimetričnih karbohidrazona

Edi Topić, Mirta Rubčić, Jana Pisk, Višnja Vrdoljak

Division of General and Inorganic Chemistry, Department of Chemistry, Faculty of Science, University of Zagreb, Croatia

E-mail: etopic@chem.pmf.hr

Hydrazones, as structurally adaptable and functionally diverse systems, assume a number of practical roles as *e.g.* cytotoxic agents [1] or anion receptors [2], while their Mo(VI) complexes have demonstrated their value as effective epoxidation (pre)catalysts [3]. In this wide class of compounds, carbohydrazones have a special place, owing to the structural versatility of their mono- and disubstituted derivatives [4]. The possibility of tailoring them in asymmetric fashion, creating in return systems with two different subunits, varying in chelating behaviour and acid-base properties, offers a versatile platform for testing them as metalloorganic and supramolecular building blocks. To investigate carbohydrazones in this context, multifunctional asymmetric compounds bearing hydroxyaryl and pyridyl moieties were derived and tested for their chelating and anion receptor behaviour.

Dioxomolybdenum(VI) complexes and carbohydrazonium polyoxomolybdates (POMs) were prepared by crystallization from solution and by mechanochemical synthesis. To explore alternative routes towards corresponding POM salts, dioxomolybdenum(IV) complex decomposition and salt metathesis reactions were explored as well. The results evidence that different reaction conditions, in particular solvent choice and water content, along with the starting carbohydrazone structure affect the reaction outcome and the structure of the products obtained. Whereas dioxomolybdenum(VI) complexes have their structures determined by strongly chelating hydroxyaryl subunit, structures of POM salts are shaped by delicate competition between $\text{CONH}\cdots\text{O}_{\text{POM}}$, $\text{NH}^+_{\text{py}}\cdots\text{O}_{\text{POM}}$ and $\text{OH}_{\text{ar}}\cdots\text{O}_{\text{POM}}$ intermolecular hydrogen bonds (Figure 1).

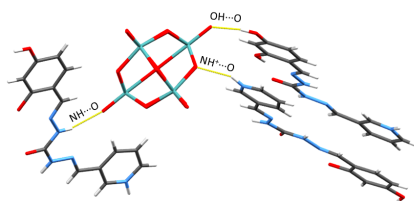

Figure 1: Hydrogen bonding diversity in asymmetric carbohydrazonium polyoxomolybdate.

References

- [1] T. M. Asha and M. R. Prathapachandra Kurup, *Inorg. Chim. Acta* **483** (2018) 44-52.
- [2] N. Hoque, A. Basu and G. Das, *Cryst. Growth Des.* **14** (2014) 6-10.
- [3] J. Pisk, B. Prugovečki, D. Matković-Čalogović, T. Jednačak, P. Novak, D. Agustin and V. Vrdoljak, *RCS Adv.* **4** (2014) 39000-39010.
- [4] M. Rubčić, N. Galić, I. Halasz, T. Jednačak, N. Judaš, J. Plavec, P. Šket and P. Novak, *Cryst. Growth Des.* **14** (2014) 2900-2912.

Acknowledgment: This work has been fully supported by Croatian Science Foundation under the project IP-2016-06-4221.

Mechanochemical synthesis and crystal structure of new group of mixed-metal imidazolates $AMgIm_3$, A = Na, K

Mehanokemijska sinteza i kristalne strukture nove skupine miješanih metalnih imidazolata $AMgIm_3$, A = Na, K

Sanja Burazer,¹ Jasminka Popović,¹ Fabrice Morelle,² Yaroslav Filinchuk,² Radovan Černý³

¹Laboratory for Synthesis and Crystallography of Functional Materials, Division for Materials Physics, Ruđer Bošković Institute, Zagreb, Croatia

²SST/IMCN/MOST – Molecules, Solids and Reactivity, Université catholique de Louvain, Ottignies-Louvain-la-Neuve, Belgium

³Laboratory of Crystallography, DQMP, University of Geneva, Geneva, Switzerland

E-mail: sbrkic@irb.hr

Mechanochemical synthesis was used for the preparation of first bimetallic imidazolates containing alkali and alkaline earth metals, $NaMgIm_3$ and $KMgIm_3$. Preparation of $NaMgIm_3$ has been done by reaction between $NaIm$ and $Mg(BH_4)_2$ as well as directly from $NaIm$ and $MgIm_2$. Literature shows that alkali imidazolates ($NaIm$, Kim and $Lilm$) form the dense and hypercoordinated structures where the coordinative demand of the metal cation increases with an increase of the ionic radii. On the other hand, porous zeolitic imidazolate framework, $MgIm_2$, is formed by the utilization of an alkali earth metal [1,2].

In-situ high temperature XRPD experiment utilizing the synchrotron radiation was used for structural evolution and thermal stability. In both compounds, the imidazolate ligand is connected to four metal cations forming a complex 3D network with channels running along the *c*-direction. Unlike mono cation imidazolates ($NaIm$ and $MgIm_2$) which show tetrahedral coordination of metals [1], in $NaMgIm_3$ each Na and Mg cation is exhibiting distorted octahedral coordination. $NaMgIm_3$ and $KMgIm_3$ are the first members of a new family of imidazolate frameworks with *stp* topology. Formation of mixed alkali metal imidazole compounds is under thermodynamical control; reaction between $Lilm$ and $MgIm_2$ have not yielded a mixed-metal compound while Kim reacts swiftly and forms $KMgIm_3$.

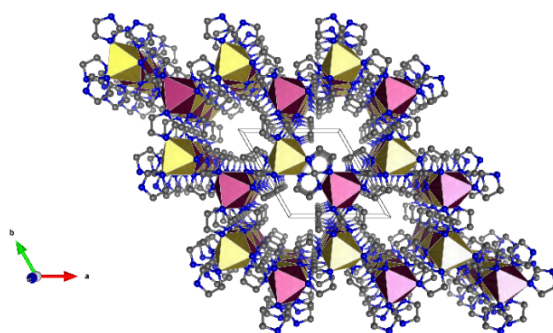

Figure 1: Extended crystal packing of $NaMgIm_3$ showing channels along *c*-direction.

References

- [1] F. Morelle, Ph.D. Dissertation, Université catholique de Louvain, Louvain-la-Neuve, Belgium, 2017.
- [2] D. A. Safin, D. A. K. Robeyns and Y. Filinchuk, Abstract at ECM 30, Basel, Switzerland, Aug. 28 – Sep. 1, 2016.

Extraction and stability analysis of phenolic compounds using natural deep eutectic solvents

Ekstrakcija i ispitivanje stabilnosti fenolnih spojeva primjenom prirodnih niskotemperaturnih eutektičnih otapala

Anamarija Mitar, Jasna Prlić Kardum, Dajana Kučić Grgić
Sveučilište u Zagrebu, Fakultet kemijskog inženjerstva i tehnologije, Zagreb, Hrvatska

E-pošta: amitar@fkit.hr

Nusprodukt nastao proizvodnjom maslinova ulja je maslinova komina koja se, zbog visokog sadržaja zaostalih fenolnih spojeva, pokazala kao bogat izvor snažnih antioksidansa primjenjivih u sprječavanju različitih bolesti. Poznato je da su slobodni radikali nastali u organizmu štetni i mogu dovesti do različitih zdravstvenih problema. Stoga, antioksidansi vezanjem slobodnih radikala mogu odgoditi ili spriječiti njihovo štetno djelovanje na organizam [1,2]. U posljednje vrijeme se, umjesto konvencionalnih otapala, za ekstrakciju biološki aktivnih komponenti primjenjuju otapala koja zadovoljavaju načela zelene kemije, a istovremeno se njihovom primjenom ostvaruje veća učinkovitost.

Prirodna niskotemperaturna eutektična otapala pripremljena su iz prirodnih komponenti te su pogodna za korištenje u prehrambenoj, kozmetičkoj i farmaceutskoj industriji. Ta otapala izazivaju veliki interes, ne samo zbog svoje netoksičnosti, nego i sposobnosti otapanja mnogih komponenti, niske su hlapivosti, nezapaljiva i imaju dobra regenerativna svojstva. Kako su ta otapala netoksična i pripremljena od komponenti koje se često koriste u kozmetici, moguća je direktna primjena dobivenog ekstrakta u kozmetičkoj industriji. Zbog sigurne primjene, bitno je ispitati stabilnost i mikrobiološku aktivnost biološki aktivnih komponenti u odabranom otapalu [3].

U ovom radu ispitani su optimalni uvjeti provedbe ekstrakcije fenolnih spojeva iz komine masline primjenom otapala pripremljenog od jabučne kiseline, fruktoze i glicerola. Ispitan je utjecaj različitih uvjeta skladištenja, poput udjela vode, temperature i vremena skladištenja na stabilnost polifenola u niskotemperaturnom eutektičnom otapalu te je određen koeficijent prijenosa tvari za definirani sustav.

Reference

- [1] C. Sanchez-Moreno, *Food Sci. Technol. Int.* **8** (2002) 121-137.
- [2] I. Mourtzinou, F. Salta, K. Yannakopoulou, A. Chiou i V.T. Karathanos, *J. Agric. Food Chem.* **55** (2007) 8088-8094.
- [3] Y. Dai, R. Verpoorte i Y. H. Choi, *Food Chem.* **159** (2014) 116-121.

Introduction of unnatural amino acids in recombinant proteins with the yeast *Pichia pastoris*

Ugradnja neprirodnih aminokiselina u rekombinantne proteine pomoću kvasca *Pichia pastoris*

Nora Tir, Lina Heistingner, Brigitte Gasser, Diethard Mattanovich

Department of Biotechnology, University of Natural Resources and Life Sciences Vienna, Austria

E-mail: nora.tir@boku.ac.at

Aminoacyl-tRNA synthetases (aaRSs) are enzymes which recognize their cognate amino acid and ligate it with the corresponding tRNA. Aminoacylated tRNAs (aa-tRNAs) participate in translation by delivering the respective amino acid to the ribosome which synthesizes a polypeptide chain. Naturally occurring suppressor tRNAs carry anticodon to stop codon and suppress a nonsense mutation which may occur in a gene by adding natural amino acid. This principle can be used for site specific incorporation of any desired amino acid in protein of interest. Some modifications of aaRSs are required for introduction of unnatural amino acids. Additionally, interactions with host cell tRNAs and aaRSs must be avoided (*i.e.* aaRS/tRNA pair being used has to be orthogonal in host cell) as well as recognition of natural amino acids.

Most commonly used aaRS/tRNA_{CUA} pairs used for recombinant protein expression in yeasts are derived from *Escherichia coli* and *Methanosarcina* spp. Modified tyrosyl- and leucyl-RS/tRNA_{CUA} pairs from *E. coli* were used in *Pichia pastoris* for incorporation of *p*-acetylphenylalanine in recombinant human serum albumin [1]. Using tyrosyl-RS/tRNA_{CUA} pair developed by the same research group and Golden Gate cloning system adjusted for expression in *P. pastoris* [2], several unnatural amino acids will be introduced in recombinant Fab fragment with the purpose of biorthogonal conjugation with the drug molecules. Many steps of Fab expression and secretion yet need to be optimized in order to reach industrially required quantities.

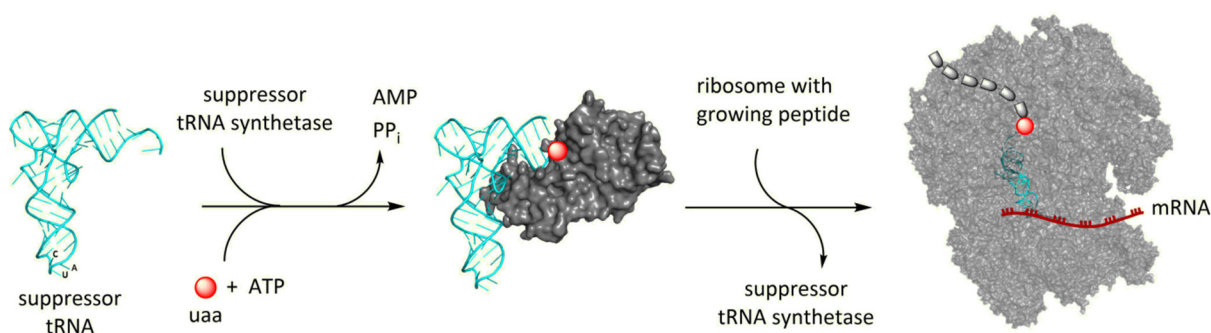

Figure 1: Incorporation of unnatural amino acid into growing peptide using a pair of suppressor RS/tRNA.

References

- [1] T. S. Young, I. Ahmad, A. Brock and P. G. Schultz, *Biochemistry* **48** (2009) 2643-2653.
- [2] R. Prielhofer, J. J. Barrero, S. Steuer, T. Gassler, R. Zahrl, K. Baumann, M. Sauer, D. Mattanovich, B. Gasser and H. Marx, *BMC Systems Biology* **11** (2017) 1-14.

Enzymatic synthesis of the iron-oxide nanoparticles using urease enzyme Enzimatska sinteza nanočestica željezovih oksida korištenjem enzima ureaze

Lela Pintarić,¹ Martina Burštinski,² Željka Bučan,² Ana Vrsalović Presečki,² Iva Rezić¹

¹Sveučilište u Zagrebu, Tekstilno-tehnološki fakultet, Zagreb, Hrvatska

²Sveučilište u Zagrebu, Fakultet kemijskog inženjerstva i tehnologije, Zagreb, Hrvatska

E-pošta: lela.pintaric@ttf.hr

Nanočestice (NČ) su čestice materijala bar jedne dimenzije manje od 100 nm koje mogu imati svojstva potpuno drugačija u odnosu na čestice istog materijala većih dimenzija uslijed čega mogu mijenjati način na koji se ponašaju sustavi unutar kojih su implementirane [1]. Primjena NČ u konstantnom je porastu u raznim područjima tehnoloških i znanstvenih inovacija, a učestalo se koriste i u tekstilnoj, farmaceutskoj, prehrambenoj i ambalažnoj industriji. Budući da konvencionalni putevi sinteze NČ često uključuju korištenje toksičnih kemikalija, njihova je upotreba za navedene primjene nerijetko ograničena zbog čega se sve veća pažnja pridaje razvoju novih, ekološki prihvatljivijih puteva sinteze biokompatibilnijih NČ, poput njihove sinteze korištenjem enzima kao u potpunosti biorazgradljivih proteina [2]. Najčešće sintetizirani oblici NČ željezovih oksida su magnetit (Fe_3O_4), maghemit ($\gamma\text{-Fe}_2\text{O}_3$) i hematit ($\alpha\text{-Fe}_2\text{O}_3$). Od njihovih se svojstava ističe magnetizam, a zanimljive su i s obzirom na činjenicu da djeluju antibakterijski na pojedine vrste bakterija [3]. Koriste se ponajviše u obradi otpadnih voda, biomedicini, za poboljšanje MR kontrasta, u kemoterapiji te za odvajanje stanica [4]. Cilj istraživanja bio je sintetizirati NČ željezovih oksida iz produkata reakcije hidrolize uree katalizirane enzimom *ureazom* uz dodatak željezova klorida. Sintetizirane NČ karakterizirane su metodom analize i praćenja nanočestica (engl. *Nanoparticle Tracking Analysis*; NTA) te skenirajućim elektronskim mikroskopom s elektronski disperzivnom spektroskopijom (engl. *Scanning Electron Microscope with Energy Dispersive Spectroscopy*; SEM-EDS). Određeni su uvjeti sinteze NČ najmanje veličine i najviše koncentracije te kinetika i mehanizam reakcije s obzirom na utjecaj koncentracije enzima *ureaze* i temperature procesa.

Zaključeno je kako su za sintezu NČ manjeg promjera prikladnije niže vrijednosti koncentracije enzima dok utjecaj temperature nije značajan. Za dobivanje više koncentracije NČ prikladniji su uvjeti srednje do više koncentracije enzima i temperature. Reakcija je opisana Michaelis-Menteničinom kinetikom, a na temelju rezultata ispitivanja utjecaja željezovih iona, zaključeno je da oni inhibiraju reakciju te da inhibicija raste porastom temperature. Prema rezultatima SEM-EDS analize zaključeno je da je viša temperatura procesa prikladnija za sintezu NČ s većim udjelom željeza.

Reference

- [1] S. Kurajica i S. Lučić Blagojević, *Uvod u nanotehnologiju, Osnovni pojmovi*, Hrvatsko društvo kemijskih inženjera i tehnologa, 2017, Zagreb; str. 5.
- [2] I. A. Adelere i A. Lateef, *Nanotechnol. Rev.* **5** (2016) 567-587.
- [3] S. S. Behera, J. K. Patra, K. Pramanik, N. Panda i H. Thatoi, *World Journal of Nano Science and Engineering* **2** (2012) 196-200.
- [4] P. Xu, G. M. Zeng, D. L. Huang, C. L. Feng, S. Hu, M. H. Zhao, C. Lai, Z. Wei, C. Huang, G. X. Xie and Z. F. Liu, *Sci. Total Environ.* **424** (2012) 1-10.

Amino- β -lactams in Ugi reaction: an efficient method for preparation of functionalized peptidomimetics

Amino- β -laktami u Ugijevoj reakciji: učinkovita metoda za pripravu funkcionaliziranih peptidomimetika

Katarina Vazdar, Ivanka Jerić
Ruđer Bošković Institute, Zagreb

E-mail: katarina.vazdar@irb.hr

Multicomponent reaction (MCR) chemistry is among the most prominent methodologies for creating diverse compounds in an economical, efficient and environmentally friendly way [1]. The efficiency of MCR chemistry has already been proven in terms of natural product synthesis [2] and drug discovery processes. Among various MCR reactions, the Ugi reaction is especially attractive since it gives rise to complex peptide-like structures in one easy synthetic step [3]. Despite having been known for its medicinal and biological importance, [4] the β -lactam moiety harbours other excellent qualities. In particular, the β -lactam ring can provide amino acid building blocks or can be expanded into macrocyclic skeletons [5]. This excellent feature makes the β -lactam moiety compatible with the MCR chemistry, thus allowing the increase in final product complexity.

Here we present a multicomponent Ugi reaction using amino- β -lactam synthon **1**, Scheme 1, as basis for construction of peptidomimetics and give a detail insight in their structural characteristics. We prepared a small library of β -lactam substituted dipeptide analogues using a variety of aromatic and aliphatic acids, isocyanides and carbonyl compounds in reaction with amino- β -lactam **1** and determined their influence on the Ugi β -lactam reaction diastereoselectivity [6].

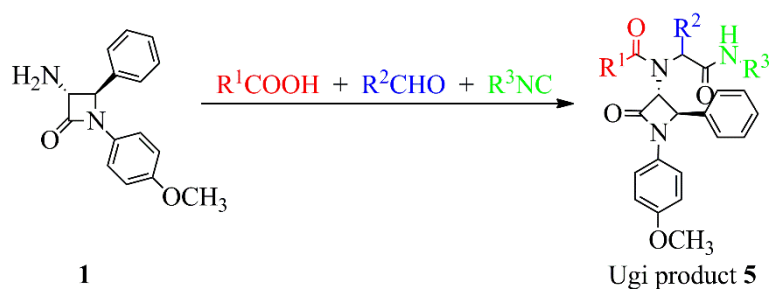

Scheme 1: Ugi reaction using amino- β -lactam **1**.

References

- [1] A. Domling, W. Wang and K. Wang, *Chem. Rev.* **112** (2012) 3083-3135.
- [2] R. Echemendía, A. F. De La Torre, J. L. Monteiro, M. Pila, A. G. Corrêa, B. Westermann, D. G. Rivera and M. W. Paixão, *Angew. Chem. Int. Ed.* **54** (2015) 7621-7625.
- [3] J. Zhang, C. Proulx, A. Tomberg and W. D. Lubell, *Org. Lett.* **16** (2014) 298-301.
- [4] J. D. Buynak, *Curr. Med. Chem.* **11** (2004) 1951-1964.
- [5] B. Alcaide, P. Almendros and C. Aragoncillo, *Chem. Rev.* **107** (2007) 4437-4492.
- [6] K. Vazdar and I. Jerić, *Tetrahedron* **74** (2018) 7495-7506.

Supramolecular chemistry of 1,1'-disubstituted ferrocene amides Supramolekulska kemija 1,1'-disupstituiranih ferrocenskih amida

Saša Opačak, Berislav Perić, Darko Babić, Mario Cindrić, Amela Hozić, Srećko I. Kirin
Institut Ruđer Bošković, Zagreb

E-mail: sasa.opacak@irb.hr

It is well known that 1,1'-amino acid disubstituted ferrocenes form well defined secondary structures which often mimic β or γ -turns. They are important for biological function and thus attractive for research [1]. When two chiral ferrocene pendant chains are hydrogen bonded, the free rotation of the ferrocene rings is hindered, and the ferrocene moiety becomes helically chiral, providing a CD signal in the visible region of the spectra which enables characterisation by chiroptic methods.

Inspired by our previous work in enantioselective hydrogenation catalysis [2], we have prepared a small series of 1,1'-disubstituted ferrocene amides and their monosubstituted analogues (Figure 1). The prepared compounds are model systems for the precatalytic Rh complexes in our previous work, and they will hopefully provide additional insight into supramolecular enantioselective catalysis. In addition, they are also interesting in their own right, as they exhibit hydrogen bonding and other types of noncovalent interactions. We have applied different spectroscopic techniques (NMR, IR, UV-Vis, CD, XRD, MS) and DFT calculation to these systems in order to elucidate their structure in solution and characterise interesting supramolecular phenomena, such as the solvent induced chirality inversion, which occur in these systems.

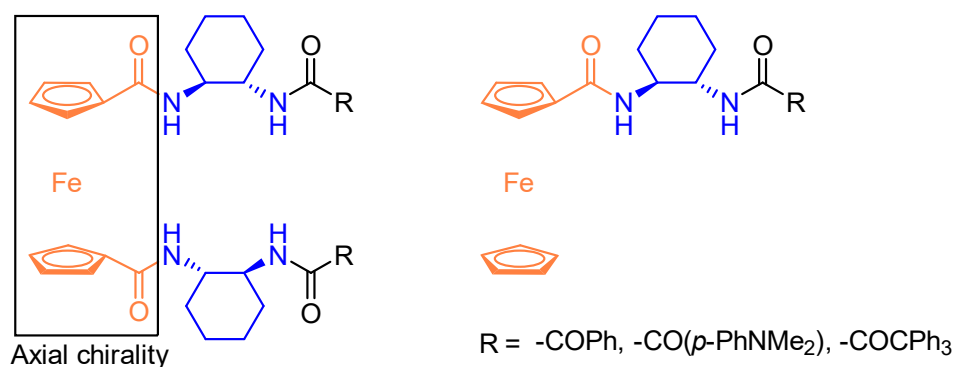

Figure 1: The disubstituted and monosubstituted ferrocenes of interest; hydrogen bonding can be achieved through amide functionalities which induces axial chirality in the ferrocene.

References

- [1] S. I. Kirin, H. B. Kraatz and N. M. Nolte, *Chem. Soc. Rev.* **35** (2006) 348-354.
[2] S. Opačak, Z. Kokan, Z. Glasovac, B. Perić and S. I. Kirin, *Eur. J. Org. Chem.* (2019), in press, DOI: 10.1002/ejoc.201801647

Achievements of organic stereochemistry in Croatia and Prelog school Dostignuća organske stereokemije u Hrvatskoj i Prelogova škola

Vitomir Šunjić

Croatian Academy of Science and Arts, Zagreb, Croatia

E-mail: vsunjic@hazu.hr

Stereochemistry, in particular asymmetric synthesis of chiral compounds in the optically pure form, represents the highlight of organic chemistry. This field was not explored by organic chemists in Croatia until 1952 [1] while the first asymmetric synthesis was published in 1960 [2]. Generations of organic chemists that studied with prof. Prelog in Zagreb (1935-1941) or spent doctoral or post-doctoral years in his laboratory at ETH in Zurich (1952-1989) are named in Croatia as "Prelog school" [3]. This term, however, is known only on the national level, while the achievements of Croatian organic stereochemistry, particularly in stereoselective and asymmetric syntheses, remained largely unknown. The authors decided to fill this gap, and to promote development of organic stereochemistry in Croatia by edition of a detailed overview [4]. Collected evidence for the period 1952-2018 revealed ca. 30 research projects on the synthesis and stereochemical studies of chiral compounds completed by the teams in Croatian industrial or academic institutions. Over this period approx. 280 papers are published and ca. 230 Croatian authors participated in stereochemical studies.

Research topics are reviewed in the chronologic order, except some industrial projects intended for production of chiral products (polymers, drugs). Academic projects are collected either according to synthetic methods, e.g. stereoselective and asymmetric synthesis completed by organometallic catalysis, organocatalysis or biocatalysis, or according to structural characteristics of the target chiral molecules (β -lactams, benzodiazepines, ferrocenes, adamantans, etc.), or by the specific properties of the target compounds (organometallic catalysts, liquid crystals, supramolecular gels, DNA-RNA ligands). The overview is primarily intended for distribution in the electronic version, available on the own home-page or on the other sites. Only limited edition of the printed book is planned. The authors expect this information to promote future collaborative projects from Croatia, in particular those supported by EU and other international funding agencies.

Few examples from various epochs are selected for this presentation to illustrate huge progress of methods and creative concepts in organic stereochemistry developed by generations of Croatian organic chemists.

References

- [1] K. Balenović and D. Fleš, *J. Org. Chem.* **17** (1952) 347-349.
- [2] K. Balenović, N. Bregant and D. Francetić, *Tetrahedron Lett.* **6** (1960) 20-22.
- [3] M. Dumić and K. Kovačević (Eds.), *Homage to Vladimir Prelog*, Faculty of Chemical Engineering and Technology, Zagreb, 2010.
- [4] V. Šunjić and K. Kovačević, *Achievements of Organic Stereochemistry in Croatia and Prelog School*, manuscript in preparation.

Analysis of the project *ZadarZaDar* – Advantages and disadvantages **Analiza projekta *ZadarZaDar* – prednosti i mane**

Andreja Kakša

Bartul Kašić Elementary School, Zadar, Croatia

E-mail: andreja.kaksa@skole.hr

Primary and secondary schools in the Republic of Croatia are craving for renewal, innovation and improvement of educational processes. Education should be adapted to contemporary life's needs, for both students with learning difficulties and potential gifted students. Thus, Bartul Kašić Elementary school in Zadar launched a project named *ZadarZaDar*. The objective of the project is to encourage work with gifted children and students at the pre-high school level of education in order to improve development of gifted students by means of experimental pedagogy in natural sciences. The project was supported by the European Structural and Investment Funds and has been realized by the help of four partner schools (Šimuna Kožičića Benje Elementary School, Zadar Islands Elementary School, Kruno Krstić Elementary School, St. Filip and Jakov Elementary School), City of Zadar and the University of Zadar.

Within the framework of the project different activities were carried out: identification of potentially gifted students, individual programs and the creation of the appropriate multimedia contents, and practical handbooks for working with gifted children [1]. Teachers in the field of natural sciences were educated on the theme of the potentially gifted students through workshops and lectures, as well as on a study trip to the Center for Research and Promotion of Giftedness at the Pedagogical Faculty of the University of Ljubljana. A cabinet and a classroom in Bartul Kašić Elementary School were outfitted, and the school partners were equipped with individual teaching sets. Over the course of 18 months, this project has been developed over and over. What are the advantages and disadvantages of this project co-financed by European funds for primary education, teachers and gifted students in chemistry? Some of the answers to this question will be brought to your attention during the presentation and some are for you to discover.

References

[1] <http://zadar-za-dar.eu/>

IUPAC, the periodic table of elements and STRUNA – Croatian chemical nomenclature and terminology
IUPAC, periodni sustav elemenata i STRUNA – hrvatsko kemijsko imenje i nazivlje

Lidija Varga-Defterdarović
Institut Ruđer Bošković, Zagreb, Hrvatska

E-pošta: Lidija.Varga.Defterdarovic@irb.hr

Ove godine je 100-ta obljetnica osnivanja Međunarodne unije za čistu i primijenjenu kemiju (*International Union of Pure and Applied Chemistry*, IUPAC) i 150-a obljetnica periodnog sustava elemenata D. I. Mendeljejeva i J. L. von Meyera. Obilježavanju ovih obljetnica pridružuje se i zajednička Sekcija za nomenklaturu i terminologiju Hrvatskoga društva kemijskih inženjera i tehnologa (HDKI) i Hrvatskoga kemijskoga društva (HKD) djelovanjem u području kemijskog imenja i nazivlja. Naime, u Hrvatskoj nomenklaturi anorganske kemije (tzv. Crvena knjiga), urednika V. Simeona iz 1996. god. imenovana su 103 kemijska elementa iz tablice periodnoga sustava elemenata. Od tada je otkriveno i IUPAC je imenovao 15 elemenata, a u Hrvatskoj nismo donijeli preporuke za njihova hrvatska imena.

Osim u imenovanju (nomenklaturi) kemijskih elemenata i spojeva, potreba za izgradnjom i promicanjem postoji i u hrvatskom kemijskom nazivlju (terminologiji). Izostanak djelovanja u tom smjeru vodi neminovnoj anglizaciji strukovnog i svakodnevnog jezika, nejasnom i nepreciznom sporazumijevanju, pa i gubitku jezičnog identiteta. Veliki pomaci u definiranju hrvatskog kemijskog imenja i nazivlja postignuti su radom na hrvatskim prijevodima IUPAC-ovih preporuka, a u novije vrijeme i sudjelovanjem naših kemičara u nacionalnom projektu Hrvatske zaklade za znanost (HrZZ) i Instituta za hrvatski jezik i jezikoslovlje (IHJJ) „Izgradnja hrvatskoga strukovnog nazivlja“ odnosno uspostavljanju terminološke baze STRUNA.

Spomenute obljetnice prigoda su za otvaranje rasprava i usuglašavanja po pojedinim pitanjima i nedoumicama vezanim za kemijsko imenje i nazivlje na nacionalnom nivou, te uključivanje zainteresiranih kemijskih stručnjaka fakulteta Sveučilišta u Hrvatskoj, srednjoškolskih i osnovnoškolskih nastavnika kemije, Agencije za odgoj i obrazovanje, izdavača udžbenika i Instituta za hrvatski jezik i jezikoslovlje. Usuglašena hrvatska imena novih kemijskih elemenata dobit će, odobrenjem naših dvaju kemijskih društava, status preporučenih.

**POSTERSKA PRIOPĆENJA
KEMIJA**

***POSTER PRESENTATIONS
CHEMISTRY***

Study of hybrid G-quadruplex structures by surface-enhanced Raman scattering spectroscopy
Istraživanje hibridnih struktura G-kvadrupleksa spektroskopijom površinski pojačanog Ramanova raspršenja

Adriana Kendel,¹ Francesco Papi,² Marina Ratkaj,³ Ivo Piantanida,⁴ Snežana Miljanić¹

¹Department of Chemistry, Faculty of Science, University of Zagreb, Zagreb, Croatia

²Department of Chemistry "Ugo Schiff", University of Firenze, Firenze, Italy

³Teva Pharmaceutical Industries Ltd., Research and Development, PLIVA Croatia, Zagreb, Croatia

⁴Division of Organic Chemistry and Biochemistry, Ruđer Bošković Institute, Zagreb, Croatia

E-mail: akendel@chem.pmf.hr

G-quadruplexes (G4) are nucleic acid structures formed by guanine-rich sequences, involved in multiple processes in living cells, including DNA transcription, replication, translation and end-protection of telomeres [1]. Human telomeric sequences can fold into three main G4 arrangements, namely parallel, antiparallel and hybrid, whereby parallel and hybrid structures are the most interesting since they are usually found in solutions rich in potassium that are quite similar to the conditions within the living cells [2, 3].

Surface-enhanced Raman scattering (SERS) and circular dichroism (CD) spectroscopy were used to investigate the human telomeric sequences Tel26 d[A₃G₃(TTAGGG)₃A₂] and wtTel26 d[(TTAGGG)₄T₂] at different concentrations (10, 30, 50 μM) in potassium solutions. Studied telomeric sequences can fold into hybrid-1 and hybrid-2 G4 forms in dilute solutions, differing in the order of the loops arrangement [4]. In the SERS spectra characteristic G-quadruplex marker bands were noted. Intensity ratios of guanine characteristic SERS bands revealed C2'-endo/syn and C2'-endo/anti conformations in G-quadruplexes, while intensity ratios of adenine and guanine breathing bands proved presence of the folded telomeric sequences on the silver surface [5]. Though the SERS spectra of Tel26 and wtTel26 shown similar patterns, as expected because of hybrid-1 and hybrid-2 structural resemblance, a series of different spectral features were observed, indicating that adenine and thymine residues play a determinant role in interactions with the metallic surface. It was suggested that Tel26 tends to adsorb by its double-chain-reversal side loop (predominately hybrid-1 G4), while wtTel26 most likely approaches the metallic surface by one of its lateral loops. CD spectroscopy confirmed the folding of Tel26 and wtTel26 into the hybrid G4 structures, which were not affected by adsorption onto the enhancing silver nanoparticles.

References

- [1] D. Rhodes and H. J. Lipps, *Nucleic Acids Res.* **43** (2015) 8627-8637.
- [2] A. T. Phan, *FEBS J.* **277** (2010) 1107-1117.
- [3] G. N. Parkinson, M. P. Lee and S. Neidle, *Nature* **417** (2002) 876-880.
- [4] J. Dai, C. PUNCHIHEWA, A. AMBRUS, D. CHEN, R. A. JONES and D. YANG, *Nucleic Acids Res.* **35** (2007) 2440-2450.
- [5] S. Miljanić, M. Ratkaj, M. Matković, I. Piantanida, P. Gratteri and C. Bazzicalupi, *Anal. Bioanal. Chem.* **409** (2017) 2285-2295.

Density functional theory study of Diels-Alder cycloadditions of vinyl carbodiimides with *N*-alkyl imines

Studij Diels-Alderove cikloadicije vinil karbodiimida s *N*-alkil-iminima teorijom funkcionala gustoće

Akmaral Kussayeva, Zoran Glasovac, Davor Margetić
Ruđer Bošković Institute, Zagreb, Croatia

E-mail: akmaral.kussayeva@irb.hr

Guanidines are commonly occurring functionality in nature and aminoacid arginine plays an important role in biosynthesis of proteins [1]. The physico-chemical properties of guanidines, especially their high basicity is particularly interesting [2]. Various synthetic methods were employed in synthesis of guanidines, and cycloaddition reactions involving guanidines and cycloaddition reactions employed in the synthesis of cyclic guanidines are not well explored [3].

Here we present the results of computational study of Diels-Alder cycloadditions of vinyl carbodiimides with *N*-alkyl imines which were used in synthesis of bicyclic guanidines, but the mechanism was not fully investigated [4]. DFT calculations using the B3LYP (Becke 3-parameter, Lee-Yang-Parr) hybrid functional and 6-31G(d) basis set indicate that the asynchronous concerted [4+2] cycloaddition process proceeds through the *endo*- or *exo*-transition states.

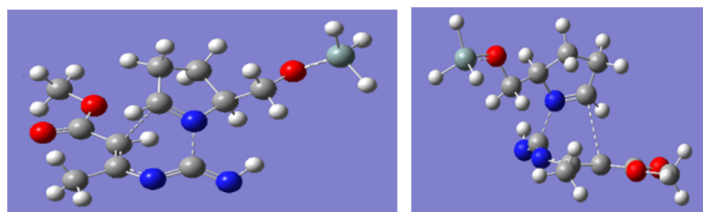

Scheme 1: *Exo*- and *endo*- transition states.

References

- [1] D. A. Bender, *Amino Acid Metabolism*, Wiley-Blackwell, Chichester, 2012, pp. 157-223.
- [2] D. Margetić, *Physico-Chemical Properties of Organosuperbases*, in *Superbases for Organic Synthesis: Guanidines, Amidines, Phosphazenes and Related Organocatalysts*, T. Ishikawa (Ed.), Wiley, Chichester, 2009, pp. 9-48.
- [3] D. Margetić, *Cycloadditions of guanidines*, in: *Cycloaddition Reactions: Advances in Research and Applications*, D. Margetić (Ed.), Nova Science Publishers, Hauppauge, New York, 2019.
- [4] M. A. Arnold, K. A. Day, S. G. Durón and D. Y. Gin, *J. Am. Chem. Soc.* **128** (2006) 13255-13260.

Acknowledgment: This work was supported by the Ministry of Science, Education and Sport of Croatia (grant No. HrZZ IP-2018-01-3298 CycloGu).

Covalent modification of MWCNT with quaternary ammonium groups Kovalentna modifikacija MWCNT kvarternim amonijevim skupinama

Gabriela Ravnjak, Andrea Dandić, Mateja Budetić, Mirela Samardžić, Aleksandar Sečenji
Department of Chemistry, Josip Juraj Strossmayer University of Osijek, Osijek, Croatia

E-mail: szealex@kemija.unios.hr

Since their discovery, carbon nanotubes (CNT) have been found to be a promising material for various applications because of their unique properties like electric conductivity, mechanical strength and chemical stability. Some of the most explored fields of applications are electronics, drug delivery, composite material production, catalysis [1] and chemical sensing applications [2]. For most of the applications some kind of modification of CNT is required. Non-covalent modification can be performed without disrupting the structure of both single wall (SWCNT) and multi walled CNT (MWCNT). Covalent modification of SWCNT can lead to a loss of advanced properties like electric conductivity because of the structural changes [3], while properties of MWCNT are not affected by this modification. Here we present a new covalent modification of pristine MWCNT by quaternary ammonium groups and their characterization. The quaternary ammonium groups have been introduced in a multi-step reaction. The first step was nitration which was performed by treatment of MWCNT with the mixture of concentrated HNO₃ and H₂SO₄ in the 9:10 volume ratio at 60 °C and for 3 hours. The nitro groups were reduced to amine groups by Bechamp reduction, by applying Fe powder and hydrochloric acid, in ethanol reflux for 2 hours. After purification of amine-modified MWCNT, direct quaternization of amine groups was performed with the application of CH₃I, in dimethylformamide at room temperature. The modification steps were followed with FTIR and ¹³C and H NMR characterization.

References

- [1] R. Barthos, A. Széchenyi and F. Solymosi, *Catal. Lett.* **120** (2008) 161-165.
- [2] M. Hajduković, M. Samardžić, O. Galović, A. Széchenyi and M. Sak-Bosnar, *Sens. Actuators B Chem.* **251** (2017) 795-803.
- [3] H. Park, J. Zhao and J. P. Lu, *Nano Lett.* **6** (2006) 916-919.

Effect of temperature on dicyclopalladation of 4-dimethylaminoazobenzenes Utjecaj temperature na reakcije diciklopaladacije 4-dimetilaminoazobenzena

Zrinka Duvnjak,¹ Ivan Džajić,¹ Alen Bjelopetrović,² Marina Juribašić Kulcsar,² Manda Ćurić,²
Ana Budimir³

¹Graduate Study of Pharmacy, University of Zagreb, Zagreb, Croatia

²Division of Physical Chemistry, Ruđer Bošković Institute, Zagreb, Croatia

³University of Zagreb, Faculty of Pharmacy and Biochemistry, Zagreb, Croatia

E-mail: abudimir@pharma.hr

Cyclometallation is one of the simplest and most common methods for creating a metal-carbon (M–C) bond and represents a very mild route for activating strong and unreactive carbon-hydrogen (C–H) bond with transition metals [1]. Cyclopalladated compounds have been vastly investigated due to their unique chemical and physical properties that, when fully explored, enable them for application ranging from catalysts and active units in sensors to cancer treatment agents [1]. In this regard, complexes with azobenzenes are particularly interesting. Azobenzene and its derivatives undergo reaction with Pd(II) convenient precursors readily to produce single or double cyclopalladated complexes containing one or two metalacycles. Although a number of studies of formation of cyclopalladated azobenzenes have been reported, the amount of information on the kinetics and mechanism of cyclopalladation is limited. Our previous study of palladation of azobenzenes by PdCl₂(DMF)₂ suggest that the dipalladation reaction mechanism in solution consists of four successive steps (Scheme 1): (i) co-ordination of the azobenzene to the palladium *via* one of azo-nitrogens, (ii) intramolecular C–H bond activation leading to the formation of a monopalladated complex, (iii) formation of a monopalladated adduct in which the free azo-nitrogen coordinates the second Pd atom, and (iv) the second intramolecular C–H bond activation producing a dipalladated product [2]. As a continuation of this work, herein we report the kinetic study of the effect of temperature on the reaction of dicyclopalladation of 4-dimethylaminoazobenzenes (**1-5**).

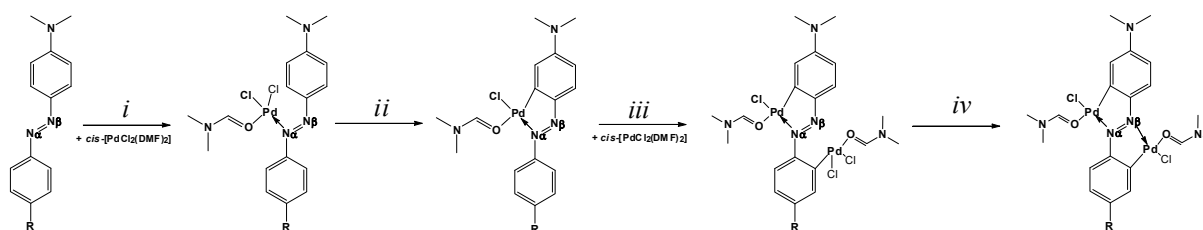

Scheme 1: R = H (**1**); R = Cl (**2**); R = I (**3**); R = NO₂ (**4**); R = COOH (**5**).

References

[1] J. Dupont, C. S. Consorti and J. Spencer, *Chem. Rev.* **105** (2005) 2527-2571.

[2] M. Juribašić, A. Budimir, S. Kazazić and M. Ćurić, *Inorg. Chem.* **52** (2013) 12749-12757.

One-step mechanosynthesis of organopalladium compounds *via* anion replacement

Mehanokemijska sinteza organopaladijevih spojeva izmjenom anionskih liganada u jednom koraku

Alen Bjelopetrović, Darko Babić, Marko Robić, Marina Juribašić-Kulcsár, Manda Ćurić
Division of Physical Chemistry, Ruđer Bošković Institute, Zagreb, Croatia

E-mail: abjelop@irb.hr

Cyclopalladated complexes or palladacycles are successfully applied in organic synthesis and catalysis, as well as in many areas of material science and biological chemistry [1]. The synthesis of palladacycles usually relies on solvent-based protocol which may require elevated temperatures and toxic solvents, and is often time-consuming.

Recently, we have employed ball-milling methods for the synthesis of a series of mono- and/or dicyclopalladated azobenzenes *via* C–H bond activation, known as cyclopalladation, using common Pd(II) precursors. The desired products were obtained in high yields and in shorter reaction time than in the solution [2].

Herein we describe the one-step mechanosynthesis of palladacycles by substitution of anionic ligands in the ball mill solvent-free conditions. The mutual exchange of chloride, acetate, tetrafluoroborate and acetylacetonate ligands in mono- and/or dicyclopalladated azobenzenes yielded desired products, some of which were inaccessible *via* direct C–H bond activation with Pd(II) precursors. The products were obtained in high yields with shorter reaction times than those under a solvent-based protocol. The starting compounds and products were characterised in the solid state by using PXRD, Raman and IR spectroscopies, and by ¹H-NMR spectroscopy in solution.

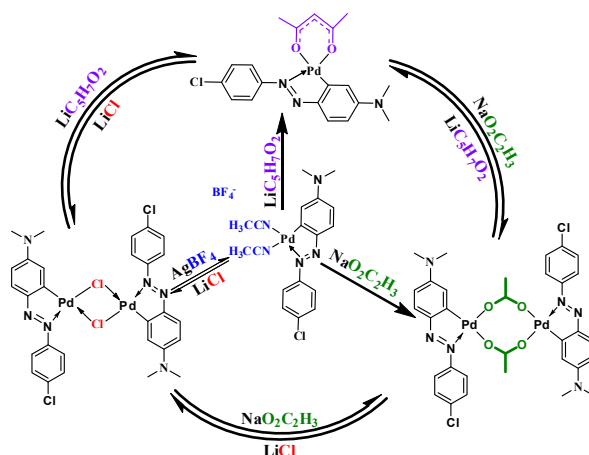

Scheme 1: Ligand exchange reactions in monopalladated azobenzene derivative.

References

- [1] J. Dupont and M. Pfeffer (Eds.), *Palladacycles: Synthesis, Characterization and Applications*, Wiley–VCH, Weinheim, 2008.
- [2] A. Bjelopetrović, S. Lukin, I. Halasz, K. Užarević, I. Đilović, D. Barišić, A. Budimir, M. Juribašić Kulcsár and M. Ćurić, *Chem. Eur. J.* **24** (2018) 10672-10682.

Design, synthesis and characterisation of *Cinchona* alkaloid carbamates Dizajn, sinteza i svojstva karbamata *Cinchona* alkaloida

Alma Ramić,¹ Ana Matošević,² Anita Bosak,² Zrinka Kovarik,² Tomica Hrenar,¹ Ines Primožič¹

¹Sveučilište u Zagrebu, Prirodoslovno-matematički fakultet, Zagreb, Hrvatska

²Institut za medicinska istraživanja i medicinu rada, Zagreb, Hrvatska

E-mail: alma.ramic@chem.pmf.hr

Cinchona alkaloids and their derivatives are useful in organic chemistry as organocatalysts in stereoselective syntheses, but due to their various bioactive properties they are also very important in medicinal chemistry. To investigate a new class of potentially bioactive *Cinchona* alkaloids, a series of mono- and disubstituted aliphatic (methyl, ethyl and cyclohexyl groups) and mono- and disubstituted aromatic (phenyl groups) cinchonine carbamates and their corresponding *pseudo*-enantiomeric cinchonidine carbamates have been prepared and characterized. Structural properties of prepared compounds were studied by FT-IR, 1D and 2D ¹H and ¹³C NMR spectroscopy. Since some derivatives of cinchonidine have been previously identified as inhibitors of cholinesterases, [1,2] all prepared carbamate derivatives were screened for their ability to inhibit human acetylcholinesterase and butyrylcholinesterase activity. To explain the differences of the determined carbamylation rates of *pseudo*-enantiomeric carbamates, quantum chemical calculation were used to determine transition states of the carbamylation reaction. Full conformational analysis was performed for all compounds and multi-way methods were used to correlate inhibition activities with theoretical results. Synthesis, physicochemical characterisation and classification model build by principal component analysis for all compounds will be discussed.

References

- [1] M. Katalinić, A. Zandona, A. Ramić, T. Zorbaz, I. Primožič and Z. Kovarik, *Molecules* **22** (2017) 123, 1-13.
[2] A. Bosak, A. Ramić, T. Šmidlehner, T. Hrenar, I. Primožič and Z. Kovarik, *PLoS One* **1** (2018) 1.

Acknowledgment: Supported by Croatian Science Foundation, Projects No. IP-2016-06-3775 ADESIRE and IP-2018-01-7683 AnalyseBChE.

Microwave-assisted synthesis of 2(1H)-quinolone vs conventional synthesis Mikrovalna sinteza 2(1H)-kinolona nasuprot klasičnoj sintezi

Andjela Buljan,^{1,2} Irena Dokli,¹ and Marin Roje^{1,2}

¹Ruđer Bošković Institute, Zagreb, Croatia

²Center of Excellence for Marine Bioprospecting – BioProCro, RuđerBošković Institute, Zagreb, Croatia

E-mail: Andjela.Buljan@irb.hr

Quinolones are an important class of molecules present as a structural motif in a number of biologically active natural products and synthetic drugs. Due to its known activity as a pharmacophore, quinolone moiety attracted considerable attention of medicinal and synthetic organic chemists [1]. Our interest was primarily focused on the construction of *N*-substituted 4-methyl-2(1H)-quinolone **2** as the key intermediate in the total synthesis of marinoaziridines A and B, Scheme 1. Marinoaziridines A and B are the first aziridine-containing natural products isolated from Gram-negative bacteria from marine sediment [2]. Their absolute configuration is so far unknown as well as their total synthesis.

The synthesis of 2(1H)-quinolone derivatives starting from suitably protected aniline and ethyl-acetoacetate is a two-step process based on the attack of amine on the ester function, which is thermodynamically favored, and occurs when the reaction is carried out at 180 °C [3]. The second step involves cyclisation of acetoacetanilides **1** under harsh acidic conditions. The quinolone derivative was prepared *via* conventional method based on the above reaction sequence in a low yield (8 %) within long reaction time (7 days), together with unwanted byproducts. In an effort to improve yield and purity of the target product, and also to reduce reaction time, the synthesis was carried out under microwave irradiation. Efforts were made to optimize reaction conditions (power, temperature, time) for the first step, and to test a range of additives for the second step of reaction. Obtained results opened up the possibility of using different protecting groups, which are not stable under harsh acidic conditions.

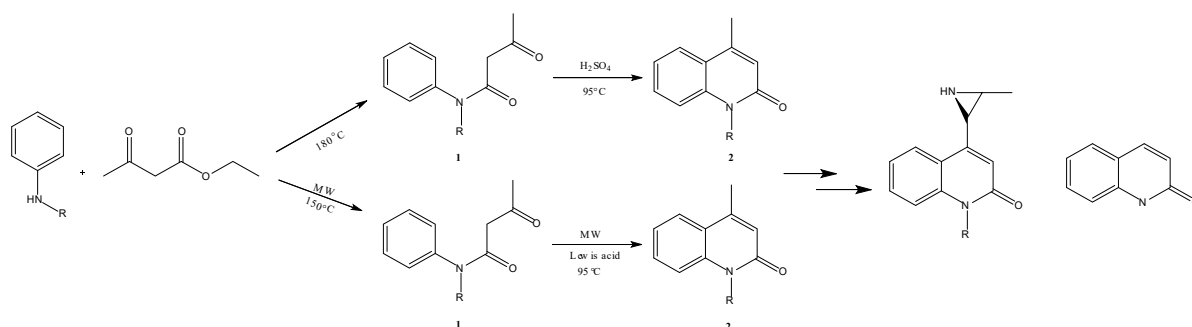

Scheme 1: Synthesis of *N*-substituted 2(1H)-quinolones **2** as the key intermediates in the total synthesis of Marinoaziridines A and B.

References

- [1] J. Wu, S. Xiang, J. Zang, M. Leow and X.-W. Liu, *Org. Lett.* **17** (2015) 222-225.
- [2] E. J. Choi, S.-J. Nam, L. Paul, C. A. Kauffman, P. R. Jensen and W. Fenical, *Chem. Biol.* **22** (2015) 1270-1279.
- [3] A. S. C. Fonseca, M. S. T. Gonçalves and S. P. G. Costa, *Amino Acids* **39** (2010) 699-712.

Free radical scavenging potency of ferulic acid phenoxyl radical – a thermodynamic study

Termodinamička studija potencijala hvatanja slobodnih radikala fenoksilnim radikalom ferulinske kiseline

Ana Amić,¹ Zoran Marković,² Dejan Milenković³

¹Department of Chemistry, Josip Juraj Strossmayer University of Osijek, Osijek, Croatia

²State University of Novi Pazar, Novi Pazar, Serbia

³Bioengineering R&D Center, Kragujevac, Serbia

E-mail: aamic@kemija.unios.hr

Ferulic acid is a ubiquitous plant constituent and it is more bioavailable than other dietary phenolics. In systemic circulation it could be present in sufficient concentrations to exert biological activities, such as direct free radical scavenging [1,2]. Inactivation of free radicals (*e.g.*, the most dangerous HO[•]) by H-atom donation from the phenolic OH group of ferulic acid results in the formation of the corresponding phenoxyl radical (PhR) ($\Delta_r G = -28.31$ kcal mol⁻¹). In this DFT study at M06-2X/6-31G(d) level of theory we are dealing with the thermodynamics of possible subsequent reactions (a-c) which PhR (**1**) may undergo (Figure 1). Another HO[•] free radical may be quenched by the OCH₃ group of PhR resulting in the formation of 3,4-(methylenedioxy)cinnamic acid (**2**) ($\Delta_r G = -72.04$ kcal mol⁻¹) (a). Distribution of the unpaired electron in PhR (*e.g.*, spin density and Fukui function for radical attack) indicates reactive sites. We found that the addition of HO[•] to C-5 of PhR ($\Delta_r G = -50.13$ kcal mol⁻¹) is favoured by keto-enol tautomerization which is highly thermodynamically driven ($\Delta_r G = -25.35$ kcal mol⁻¹) (b). Obtained 5-hydroxyferulic acid (**3**) *via* its catechol moiety has potential of inactivation of another two HO[•] free radicals. PhR may also undergo dimerization reactions (c). Our results indicate that the most favoured dimer results *via* C-5–C-5 linkage ($\Delta_r G = -6.49$ kcal mol⁻¹) due to stabilization by keto-enol tautomerization ($\Delta_r G = -39.47$ kcal mol⁻¹). C-5–C-5 dimer possesses two guaiacyl moieties and has potential to inactivate another four HO[•] free radicals. By comparison of obtained $\Delta_r G$ values of investigated processes (Figure 1) it appears that the inactivation of PhR by radical adduct formation (b) is thermodynamically most favoured.

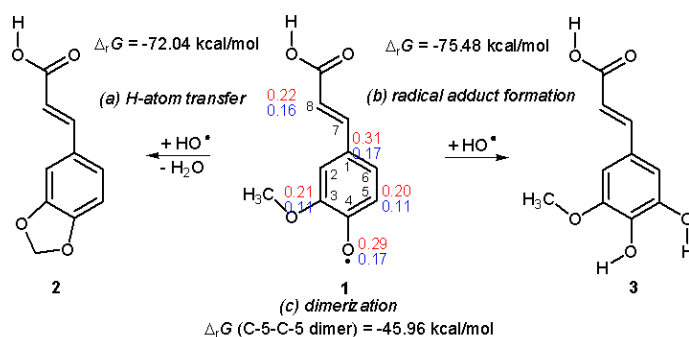

Figure 1: Studied processes of inactivation of ferulic acid phenoxyl radical.

References

- [1] M. Srinivasan, A. R. Sudheer and V. P. Menon, *J. Clin. Biochem. Nutr.* **40** (2007) 92-100.
[2] A. Galano and J. R. Alvarez-Idaboy, *Int. J. Quantum Chem.* **119** (2019) e25665.

Buchwald-Hartwig amination of the chloro substituted benzobicyclo[3.2.1]octadiene skeleton

Buchwald-Hartwigova aminacija klorom supstituiranog benzobiciklo[3.2.1]oktadienskog skeleta

Ana Ratković, Irena Škorić

Department of Organic Chemistry, Faculty of Chemical Engineering and Technology, University of Zagreb, Zagreb, Croatia

E-mail: aratkov@fkit.hr

Aryl amines are very important compounds in organic synthesis because of their numerous roles in chemistry, pharmaceuticals, materials sciences and polymers [1]. Transition metal catalyzed C-N bond formation has become a prevailing and reliable method for the synthesis of a variety of aromatic amines under mild and convenient conditions [1-3]. Promising test results on cholinesterase inhibitory activity of previously described benzobicyclo[3.2.1]octadienes [4] prompted us to continue with the further functionalization of this basic skeleton. Novel benzobicyclo[3.2.1]octadiene benzylamines were prepared for the first time by Buchwald-Hartwig amination from the photoproduct obtained by highly efficient continuous flow-photochemistry setup [5]. The novel amino substituted benzobicyclo[3.2.1]octadienes are especially interesting because of their methano-bridged junction of the three aromatic units at defined geometries as this gives them potential as molecular clips with very promising ADME (absorption, distribution, metabolism, and excretion) properties due to the amino functional group [6].

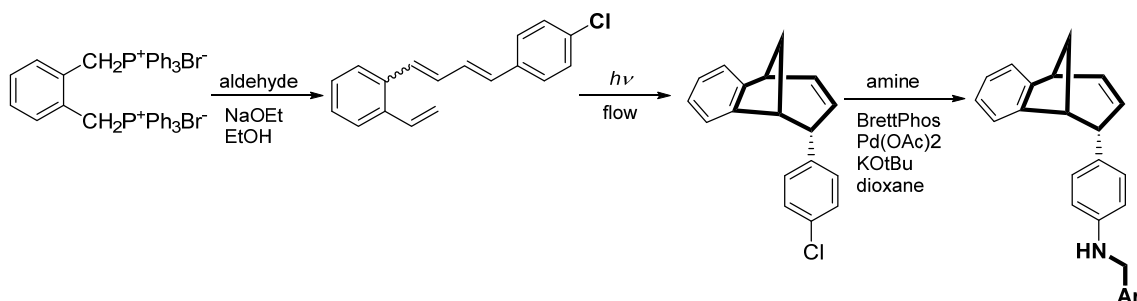

Figure 1: Synthesis of new benzobicyclo[3.2.1]octadiene benzylamines.

Also, new amino derivatives should have better ADME properties, especially $\log P$ values which determine that those compounds could possess good blood-brain barrier penetration capability and exhibit CNS activity.

References

- [1] P. Ruiz-Castillo and S. L. Buchwald, *Chem. Rev.* **116** (2016) 12564-12649.
- [2] Y. Q. Fang, R. Karisch and M. Lautens, *J. Org. Chem.* **72** (2007) 1341-1346.
- [3] M. Nirmala, *J. Organometallic Chem.* **831** (2017) 1-10.
- [4] Results in the process of publishing
- [5] A. Ratković, Ž. Marinić and I. Škorić, *J. Mol. Struct.* **1168** (2018) 165-174.
- [6] A. Ratković, V. Kelava, Ž. Marinić and I. Škorić, *J. Mol. Struct.* **1179** (2019) 597-607.

Gas-phase basicity of cyclic guanidine derivatives – a DFT study DFT studij bazičnosti cikličkih derivata gvanidina u plinskoj fazi

Anamarija Briš, Zoran Glasovac, Davor Margetić
Ruđer Bošković Institute, Zagreb, Croatia

E-mail: abris@irb.hr

Natural and synthetic guanidines are drawing much interest due to their interesting physico-chemical properties [1]. Guanidines are commonly occurring functionality in nature, therefore, a lot of research has been done in bioorganic chemistry with the aim to discover and design pharmacologically active guanidine derivatives [2]. Also, the very high basicity (superbasicity) of neutral organic guanidine compounds is commonly employed in homogeneous catalysis [1]. There are already many different studies on basicity of different guanidine derivatives with the focus on finding new organic superbases and developing synthesis of those compounds [3]. Among various examples, 1,5,7-triazabicyclo[4.4.0]dec-5-ene (TBD) is a well-known, commercially available cyclic superbase.

Herein, we report our methodical study of the gas-phase basicity (GB) of various cyclic guanidine derivatives by Density Functional Theory (DFT) calculations using the B3LYP functional. Considered guanidines differ in the number of nitrogen atoms incorporated in heterocyclic rings as well as in the size of heterocyclic rings (Scheme 1). To locate the most stable structures of the neutral and protonated forms, a set of possible conformations was optimized. The most important structural parameters beneficially contributing to the stability of the structure were identified.

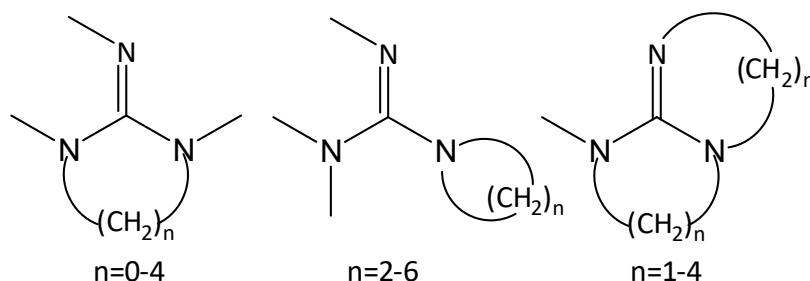

Scheme 1: Schematic representation of the studied guanidine derivatives.

References

- [1] D. Margetić, *Physico-Chemical Properties of Organosuperbases*, in *Superbases for Organic Synthesis: Guanidines, Amidines, Phosphazenes and Related Organocatalysts*, T. Ishikawa, (Ed.), Wiley, 2009, Chichester, pp: 9-48.
- [2] R. G. S. Berlinck and S. Romminger, *Nat. Prod. Rep.* **33** (2016) 456-490.
- [3] V. Štrukil, I. Antol and Z. Glasovac, *Croat. Chem. Acta* **87** (2014) 423-430; Z. Glasovac, F. Pavošević, V. Štrukil, M. Eckert-Maksić, M. Schlangen and R. Kretschmer, *Int. J. Mass Spect.* **354/355** (2013) 113-122; Z. Glasovac, M. Eckert-Maksić and Z. B. Maksić, *New J. Chem.* **33** (2009) 588-597.

Acknowledgment: This work was supported by the Ministry of Science, Education and Sport of Croatia (grant No. HrZZ IP-2018-01-3298 CycloGu).

Concentrations of mercury in the samples of maternal blood and hair, placenta and umbilical cord blood associated with the seafood consumption
Koncentracije žive u uzorcima majčine krvi i kose, posteljici i krvi iz pupčane vrpce u povezanosti s konzumacijom hrane morskoga podrijetla

Ankica Sekovanić,¹ Tatjana Orct,¹ Jasna Jurasović,¹ Martina Piasek,¹
Antonija Sulimanec Grgec,¹ Anja Bošnjaković,¹ Marijana Matek Sarić²
¹Institut za medicinska istraživanja i medicinu rada, Zagreb, Hrvatska
²Sveučilište u Zadru, Odjel za zdravstvene studije, Zadar, Hrvatska

E-pošta: asekovanic@imi.hr

U procjenjivanju izloženosti toksičnim metalima i njihovih rizika za zdravlje upotrebljavaju se metode tzv. biološkog monitoringa ljudi koje uključuju određivanje pouzdanih bioloških pokazatelja izloženosti. Ne postoji idealan uzorak (matrica) za svaku situaciju. Razine metala u krvi vrijedni su pokazatelji izloženosti, jer je krv u doticaju i ravnoteži sa svim tkivima i organima u tijelu. No, to nije jedina matrica za određivanje kemijskih tvari u tragu koje se trajno nakupljaju u organizmu, kao što su toksični metali i, pored toga, skupljanje krvi je invazivan postupak podložan etičkim i praktičnim ograničenjima, osobito u osjetljivim skupinama stanovništva kao što su trudnice i parovi majka-novorodjenče. Stoga se u istraživanjima osjetljivih skupina preporučuje, po mogućnosti, ponovna uporaba prije skupljenih uzoraka i neinvazivno skupljanje matrica kao što su posteljica i krv iz pupčane vrpce nakon porođaja, a kod procjene izloženosti živi prehranom (gdje je zastupljena pretežito u obliku metil-Hg) još i kosa, kao etički prihvatljive, ekonomične i toksikološki relevantne alternative za određivane biološke pokazatelje. Cilj dijela istraživanja koji se provodi u sklopu šireg projekta bio je odrediti koncentracije ukupne Hg (T-Hg) u uzorcima krvi i kosi majke te posteljici i krvi iz pupkovine (metodom ICP-MS) u parova majka-novorodjenče nakon normalnih porođaja u Općoj bolnici Zadar ($n = 96$, srednja dob ispitanica 29 godina). Učestalost unosa hrane morskoga podrijetla (pretežito ribe, svježe, zamrznute i/ili konzervirane) povećavala je koncentracije T-Hg (izražene kao medijan; 27–75 % interkvartilni raspon) u svim mjerenim biološkim uzorcima s najvećim vrijednostima T-Hg u kosi (0,442; 0,210 – 1,05 mg kg⁻¹), a T-Hg u krvi iz pupkovine (3,74; 1,27 – 7,89 μg L⁻¹) bila je veća od T-Hg u majčinoj krvi (2,39; 1,06 – 4,71 μg L⁻¹). U parova majka-novorodjenče gdje su ispitanice konzumirale hranu morskoga podrijetla (pretežito ribe) >2 puta na tjedan, razine T-Hg u bile su više oko 7 puta u majčinoj krvi i kosi, oko 4 puta u posteljici i oko 14 puta u krvi pupkovine nego u osoba koje nisu konzumirale takvu hranu. U zaključku, pokazali smo da su koncentracije T-Hg u svim mjerenim uzorcima srazmjerne s unosom morske hrane, pretežito ribe te da su očekivano veće u majčinoj kosi (oko 220 puta) kao i krvi iz pupkovine (oko 1,6 puta) nego u majčinoj krvi. Visok koeficijent korelacije (>0,80) koncentracija T-Hg u svim mjerenim uzorcima dokazuje da su u istraživanjima u parova majka-novorodjenče neinvazivno skupljeni uzorci posteljice i krvi iz pupkovine pouzdani biološki pokazatelji izloženosti visokotoksičnoj Hg zbog majčine konzumacije hrane morskoga podrijetla, pretežito ribe. Stoga se može izbjeći invazivno uzorkovanje majčine krvi i nije nužno skupljanje uzoraka kose (koji ispitanici mogu odbiti dati ili je uzorak neprikladan za analize zbog nedovoljne duljine odnosno kemijskog tretiranja kose).

Napomena: Prikazani rezultati provedeni su tijekom istraživanja unutar projekta HRZZ-IP-2016-06-1998.

Utilisation of pectin isolated from tomato peel waste as an eco-friendly tin corrosion inhibitor

Primjena pektina izoliranog iz otpada kore rajčice kao ekološki prihvatljivog inhibitora korozije kositra

Jasna Halambek,¹ Antonela Ninčević Grassino²

¹Karlovac University of Applied Sciences, Karlovac, Croatia

²Faculty of Food Technology and Biotechnology, University of Zagreb, Zagreb, Croatia

E-mail: aninc@pbf.hr

Pectin as the methylated ester of polygalacturonic acid has a wide range of applications in pharmaceutical, cosmetic and food industry. Commercially, pectin is extracted from citrus peels and apple pomace. However, some agricultural and food processing waste, like tomato peel, have attracted the interest of researchers due to their high amounts of pectin [1-2].

In that context, this work presents evaluation of pectin isolated from tomato peel as an eco-friendly tin corrosion inhibitor, using gravimetric, and electrochemical, *i.e.* potentiodynamic (PP) and impedance spectroscopy (EIS) methods. The measurements were done in solution composed by 2 % (w/v) NaCl and 1 % (v/v) acetic acid, at 25 °C in absence and presence of different concentrations of tomato peel pectin (TPP), as well as commercial apple pectin (CAP), in order to compare TPP corrosion inhibition efficiency.

The results showed that TPP inhibition efficiency values are slightly higher (59.79 % and 64.08 for PP and EIS) compared to that of CAP (54.93 % and 60.05 % for PP and EIS), which points out that pectin extracted from tomato peel acts as an efficient tin corrosion inhibitor. Thus, unutilized tomato biomass could be used as a promising, low-cost industrial resource for pectin isolation and its implementation for the development of new, eco-friendly corrosion inhibitors, instead of ordinary chemical and toxic ones.

References

- [1] M. Marić, A. Ninčević Grassino, Z. Zhu, F. J. Barba, M. Brnčić and S. Rimac Brnčić, *Trends Food Sci. Technol.* **76** (2018) 28-37.
- [2] A. Ninčević Grassino, F. J. Barba, M. Brnčić, J. M. Lorenzo, L. Lucini, S. Rimac Brnčić, *Food Chem.* **266** (2018) 47-55.

Stability of isothiocyanates in conditions mimicking hydrodistillation and microwave-assisted distillation

Stabilnost izotiocijanata u uvjetima koje oponašaju hidrodestilaciju i mikrovalovima potpomognutu destilaciju

Azra Đulović, Marijana Popović, Franko Burčul, Ivica Blažević
University of Split, Faculty of Chemistry and Technology, Split, Croatia

E-mail: azra@ktf-split.hr

Glucosinolates are thioglucosidic metabolites occurring mainly in the order Brassicales [1]. They represent natural precursors of isothiocyanates (ITCs), small molecules that contain a very electrophilic carbon atom and readily react with various nucleophiles such as hydroxy, amino, or thiol group, forming *O*-thiocarbamates, thiourea derivatives, or dithiocarbamates, respectively [2]. Degradation products induced by thermal treatment of ITCs are especially important because they have potential to contribute to wide range of properties, with an emphasis on the impact on biological activity.

A selection of two ITCs (allyl ITC as aliphatic and benzyl ITC as arylaliphatic) were subjected to stability testing. The major objective was to mimic standard hydrodistillation and microwave-assisted distillation conditions for 1 h. The same samples in an aqueous solution were heated and refluxed at 100 °C for 1 h. After distillation, volatile fractions were analyzed using GC-MS, as well as the volatiles resulting from liquid-liquid extraction of aqueous phases using dichloromethane. The presented experiments indicated that ITCs were generally stable in the cases of hydro- and microwave distillation conditions. On the other hand, decomposition of ITCs in solution under the reflux resulted in thiourea as the major degradation compound.

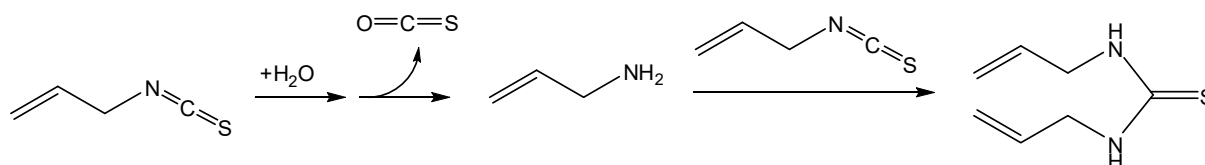

Figure 1: Scheme of possible pathways for the formation of *N,N*-diallylthiourea from allyl ITC [2].

References

- [1] I. Blažević, S. Montaut, F. Burčul and P. Rollin, *Glucosinolates: Novel sources and biological potential*, in *Glucosinolates*, J.-M. Mérillon and K. G. Ramawat (Eds.), Springer International Publishing, 2016, New York; pp: 1-58.
- [2] F. S. Hanschen, E. Lamy, M. Schreiner and S. R. Rohn, *Angew. Chem. Int. Ed.* **53** (2014), 11430-11450.

Synthesis and characterization of copper(II) complexes with glycine and heterocyclic bases

Sinteza i karakterizacija bakrovih(II) kompleksa s glicinom i heterocikličkim bazama

Biserka Prugovečki, Darko Vušak, Dubravka Matković-Čalogović
Department of Chemistry, Faculty of Science, University of Zagreb, Zagreb, Croatia

E-mail: biserka@chem.pmf.hr

Copper complexes with aminoacids as ligands are often used as model systems for investigation of copper containing proteins. Copper(II) complexes with 1,10-phenanthroline and L-Val/L-Arg/L-Leu/L-Met possess superoxide dismutase-like activities [1,2]. Moreover, copper(II) complexes with 1,10-phenanthroline possess various biological activities such as antibacterial, antifungal and antiproliferative effects on tumor cells, DNA binding and have potential application in biomedicine [3-5]. In this work we report synthesis and solid-state characterization (X-ray structural analysis, IR spectroscopy and TG/DTA analysis) of new complexes of copper(II) with glycine and a heterocyclic base (1,10-phenanthroline (phen) and 2,2'-bipyridine (bpy)), $[\text{Cu}(\text{gly})(\text{H}_2\text{O})(\text{phen})]_2\text{SO}_4 \cdot 6\text{H}_2\text{O}$ (**1**) and $[\text{Cu}(\text{gly})(\text{H}_2\text{O})(\text{bpy})][\text{Cu}(\text{gly})(\text{SO}_4)(\text{bpy})] \cdot 6\text{H}_2\text{O}$ (**2**). Complexes were synthesized in an autoclave: copper(II) hydroxide, copper(II) sulfate pentahydrate, glycine and a heterocyclic base were mixed and heated for 30 min at 120 °C. After a few days, dark blue needles of **1** and **2** were formed. In both complexes the Cu atoms have distorted square-pyramidal geometry. In **1**, Cu atom are bonded to two N atoms from the phenanthroline ligand, and N and O atoms from the glycinate ligand in a distorted square plane, with a water molecule at the apical site of the pyramid. In **2**, both Cu atoms are coordinated by two N atoms from the bipyridine and by N and O atoms from the glycinate ligand, while at the apical position there is a water molecule or a sulfate anion. Both **1** and **2** have porous structures containing infinite 1D channels containing water and occupying 12.5 % and 12.9 % of unit cell volume, respectively.

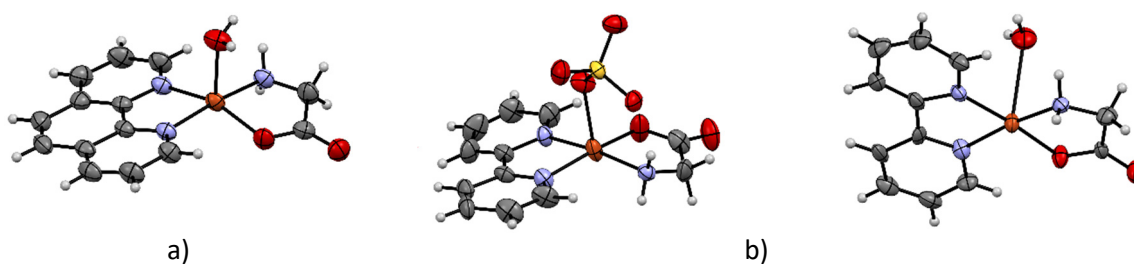

Figure 1: a) Coordination of Cu atom in **1**, b) coordination of Cu atoms in **2**.

References

- [1] X. Y. Le, S. Liao, X. P. Liu and X. L. Feng, *J. Coord. Chem.* **59** (2006) 985-995.
- [2] S. R. Liao, X. Y. Le and X. L. Feng, *J. Coord. Chem.* **61** (2008) 847-856.
- [3] D. Kannan and N. M. Arumugham, *Int. J. Res. Controlled Release* **2** (2012) 10-17.
- [4] X. Li, Z. Zhang, C. Wang, T. Zhang, K. He and F. Deng, *J. Inorg. Biochem.* **105** (2011) 23-30.
- [5] D. Vušak, B. Prugovečki, D. Milić, M. Marković, I. Petković, M. Kralj and D. Matković-Čalogović, *Cryst. Growth Des.* **17** (2017) 6049-6061.

Molecular dynamics simulations of interaction between FNR and TROL proteins included in final step of photosynthetic electron transfer
Simulacije molekulske dinamike interakcije između proteina FNR i TROL uključениh u zadnji korak fotosinteze

Branimir Bertoša,¹ Tadija Kekić^{1,2}

¹Department of Chemistry, Faculty of Science, University of Zagreb, Zagreb, Croatia

²Department of Molecular Diagnostics, Austrian Institute of Technology GmbH, Wien, Austria

E-mail: bbertosa@chem.pmf.hr

The final step of photosynthetic electron transfer from ferredoxin to NADP⁺ is catalysed by ferredoxin:NADP⁺ oxidoreductase (FNR) [1]. This photosynthetic electron transfer produces reductive power that is utilised by various enzymes involved in both chloroplast and cellular metabolism. Localization of the FNR on the chloroplastic membrane is attained by both the dynamic interaction *via* thylakoid rhodanese-like protein (TROL) and with the lasting interaction with the Tic62 protein. With goal of understanding molecular basis of these interactions at different pH, computational simulations were applied. Starting from available crystal structure of the FNR dimer in complex with ITEP domain [2], various systems consisted of the FNR proteins and the FNR binding domains (ITEP) from the TROL and Tic62 proteins were built *in silico*. Systems were subjected to molecular dynamics (MD) simulations at three different pH (6, 7 and 8). Results of simulations enabled identification of the most important regions of noncovalent interactions between involved proteins and their detailed mapping. In order to validate the results of initial simulations of the systems consisted only of wild type (WT) proteins, *in silico* mutations were introduced into the ITEP domain of TROL protein and further subjected to MD simulations. Influence of the introduced mutations to the structural properties, dynamics and stability of the protein complexes were studied. Results of MD simulations enabled identification and detailed analysis of the interface regions between the FNR proteins which consists mostly of hydrophobic interactions. Simulations shown that these regions are under strong influence of the ITEPs conserved proline and serine residues (PPS region). In conclusion, five functionally important hydrogen bond networks that span over the major structural elements of the involved proteins were identified by MD simulations and characterized in details. Three of them show pH dependence and might serve as the pH regulated switches for conformational changes of the protein complex. Histidine residues were identified as crucial for pH sensitivity of identified H-bond networks.

References

- [1] S. Juric, K. Hazler-Pilepic, A. Tomasic, H. Lepedus, B. Jelacic, S. Puthiyaveetil, T. Bionda, L. Vojta, J.-F. Allen, E. Schleiff and H. Fulgosi, *Plant J.* **60** (2009) 783-794.
[2] F. Alte, A. Stengel, J.-P. Benz, E. Petersen, J. Soll, M. Groll and B. Bölter, *Proc. Natl. Acad. Sci. USA* **107** (2010) 19260-19265.

Thermodynamics of complexes formation of dicyclopalladated 4-dimethylaminoazobenzene with nitrogen ligands in solution

Termodinamika nastajanja kompleksa diciklopaladiranog 4-dimetilaminoazobenzena s dušikovim ligandima u otopini

Dajana Barišić,¹ Ana Budimir,² Manda Ćurić,¹ Marina Juribašić Kulcsar¹

¹Division of Physical Chemistry, Ruđer Bošković Institute, Zagreb, Croatia

²Faculty of Pharmacy and Biochemistry, University of Zagreb, Zagreb, Croatia

E-mail: Dajana.Barisic@irb.hr

Palladacycles are a long-standing topic of research due to their wide application in organic transformations and catalysis, in materials science and, recently, in the design of photosensitizers and biomolecular labels [1]. In this context, we have focused our research on the organopalladium compounds with azobenzenes that exhibit strong light absorption and emission in the visible and near infrared regions, which qualifies them as good candidates for chromogenic and fluorogenic room-temperature (bio)sensors [2]. In addition, azobenzenes easily react with different Pd^{II} precursors yielding mono- or dicyclopalladated complexes, and their physical properties can be modulated by an appropriate selection of ancillary ligands or by varying the substituents on the azobenzene [1,3].

In this work we have studied for the first time the complexes formation of dicyclopalladated 4-dimethylaminoazobenzene with different nitrogen ligands, 4-substituted pyridine derivatives (Figure 1). Thermodynamic properties of those processes were evaluated by means of UV-Vis and microcalorimetric titrations in DMF and DMSO at 25 °C and it was found that one or two nitrogen containing ligands can bind to dicyclopalladated azobenzene. Results will be discussed in terms of electron-donating and electron-withdrawing properties of substituents in the 4-position of pyridine derivatives as well as the solvent donor abilities.

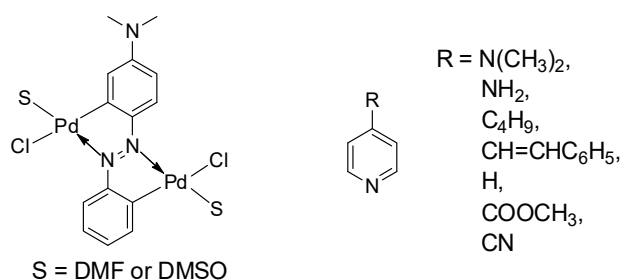

Figure 1: Structure of dicyclopalladated 4-dimethylaminoazobenzene and pyridine derivatives.

References

- [1] J. Dupont and M. Pfeffer (Eds.), *Palladacycles: Synthesis, Characterization and Applications*, Wiley-VCH, Weinheim, 2008.
- [2] (a) M. Juribašić, A. Budimir, S. Kazazić and M. Ćurić, *Inorg. Chem.* **52** (2013) 12749-12757. (b) D. Babić, M. Ćurić, K. Molčanov, G. Ilc and J. Plavec, *Inorg. Chem.* **47** (2008) 10446-10454.
- [3] (a) A. Bjelopetrović, S. Lukin, I. Halasz, K. Užarević, I. Đilović, D. Barišić, A. Budimir, M. Juribašić Kulcsár and M. Ćurić, *Chem. Eur. J.* **24** (2018) 10672-10682. (b) M. Juribašić Kulcsár, I. Halasz, A. Budimir, K. Užarević, S. Lukin, A. Monas, F. Emmerling, J. Plavec and M. Ćurić, *Inorg. Chem.* **56** (2017) 5342-5351.

Development and validation of a LC-MS/MS method for the simultaneous determination of benzimidazoles and levamisole in milk

Razvoj i validacija LC-MS/MS metode za simultano određivanje benzimidazola i levamisola u mlijeku

Damir Pavliček, Marija Denžić Lugomer

Laboratory for Analytical Chemistry and Residues, Croatian Veterinary Institute, Veterinary Institute Križevci, Križevci, Croatia

E-mail: pavlicek.vzk@veinst.hr

Levamisole and benzimidazole anthelmintics are broad-spectrum drugs that are widely used for the prevention and treatment of endoparasites in food-producing animals. The extensive use of benzimidazoles and levamisole in lactating animals could result in the presence of their residues in milk and dairy products, which is harmful to consumers owing to their teratogenic and embryotoxic properties. In order to protect the health of consumers, the European Union has established maximum residue limits (MRLs) for benzimidazole marker residues (the sum of a parent drugs and/or their metabolites) and levamisole in animal products (Commission Regulation 37/2010).

A simple, sensitive and reliable analytical method was developed for the simultaneous determination of 21 benzimidazoles (including metabolites) and levamisole in milk by liquid chromatography coupled with tandem mass spectrometry (LC-MS/MS). Samples were extracted with acetonitrile followed by liquid-liquid extraction (LLE) with *n*-hexane for lipids removal and final extracts were additionally purified by polymer cation exchange (PCX) solid phase extraction cartridges. The separation of the target analytes was carried out on Xbridge C18 column with gradient elution using acetonitrile and 10 mM ammonium acetate as mobile phase. The method allows such multi-analyte measurements within a 15 minutes runtime while the specificity is ensured through the MRM acquisition mode.

The method was validated according to the European Commission Decision 2002/657/EC determining specificity, decision limit (CC α), detection capability (CC β), recovery, precision, linearity and robustness.

For compounds which have MRLs in milk, the CC α values fall into a range from 10.2 to 109.3 $\mu\text{g}/\text{kg}$, and the CC β values fall within a range of 10.6 – 125.4 $\mu\text{g kg}^{-1}$. For compounds which do not have MRLs in milk, the CC α values fall into a range from 1.3 to 3.1 $\mu\text{g kg}^{-1}$, and the CC β values fall within a range of 1.4 – 3.5 $\mu\text{g kg}^{-1}$. The mean recoveries of the 22 analytes were between 98.2 and 102.4%. The calculated RSD values of repeatability and within-laboratory reproducibility experiments were below 23% for all compounds, with highest value of 12.6%, respectively.

The validation results demonstrate that the described LC-MS/MS method provides good sensitivity and repeatability and meets residue monitoring requirements.

Since LC-MS/MS offers the analysis of large number of components in short run time in ppb concentrations, which is of great importance in multi-residue method development, nowadays it has become the favored technique in service of ensuring safety of animal-derived foods regarding the levamisole and benzimidazole marker residues.

Influence of ions on surface properties of quartz Utjecaj iona na površinska svojstva kvarca

Danijel Namjesnik, Marija Leko, Ela Radošević, Tajana Preočanin

Kemijski odsjek, Prirodoslovno-matematički fakultet, Sveučilište u Zagrebu, Zagreb, Hrvatska

E-pošta: danijel.namjesnik@chem.pmf.hr

Pri kontaktu površine kvarca (SiO_2) s vodenim otopinama elektrolita dolazi do preraspodjele iona uz međupovršinu, nastajanja nabijenih površinskih skupina i formiranja električnog međupovršinskog sloja [1]. Ti procesi rezultiraju uspostavom potencijala uz površinu plohe koji se može mjeriti pomoću posebno konstruiranih monokristalnih elektroda. Isti procesi odvijaju se i na česticama, a mjerenje potencijala čestica provodi se metodom elektroforeze. Raspodjela iona uz površinu ovisi o gustoći i naboju aktivnih mjesta na površini monokristala. Raspodjela iona uz površinu, a tako i površinski potencijal ovise o kationima i anionima prisutnim u otopini. Ioni u otopini često se s obzirom na svoje djelovanje razvrstavaju prema Hofmeisterovu nizu, koji je inicijalno nastao prema jakosti djelovanja iona pri isoljavanju proteina, no uočljiv je i u opisivanju drugih pojava poput adsorpcije [2].

Istražen je utjecaj kationa i aniona na površinski potencijal kvarca, a opažanja su uspoređena s Hofmeisterovim nizom. Posebno je istražen utjecaj jodidnih iona ili molekula joda na površinski potencijal monokristalne elektrode, koji je neuobičajeno izražen [3-5] u usporedbi s ostalim halogenidima, što sugerira specifično vezanje tih vrsta na površinu kvarca.

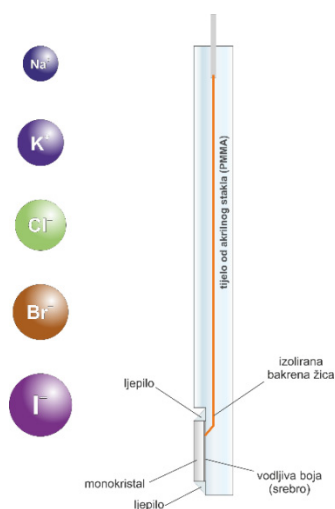

Slika 1: Shematski prikaz monokristalne elektrode za ispitivanje površinskog potencijala monokristala kvarca u ovisnosti o prisutnim ionima u otopini.

Reference

- [1] M. Pfeiffer-Laplaud, M.-P. Gageot and M. Sulpizi, *J. Phys. Chem. Lett.* **7** (2016) 3229-3234.
- [2] Z. Brkljača, D. Namjesnik, J. Lützenkirchen, M. Předota and T. Preočanin, *J. Phys. Chem. C* **122** (2018) 24025-24036.
- [3] A. E. Cameron and L. H. Reyerson, *J. Phys. Chem.* **39** (1934) 169-180.
- [4] L. H. Reyerson and A. E. Camern, *J. Phys. Chem.* **39** (1934) 181-190.
- [5] T. Nagasao and H. Yamada, *J. Raman Spectrosc.* **3** (1975) 153-160.

Napomena: Rad je izrađen uz potporu Hrv. zaklade za znanost u sklopu projekta SAQUINT (IP-2014-09-6972)

Synthesis, characterization and cytotoxicity of dioxomolybdenum(VI) complexes with 4-methoxysalicylaldehyde isonicotinoyl hydrazone Sinteza, karakterizacija i citotoksičnost dioksomolibdenovih(VI) kompleksa s 4-metoksisalicilaldehid izonikotinoil hidrazonom

Danijela Cvijanović,¹ Mirna Mandarić,² Biserka Prugovečki,² Jasna Lovrić,¹ Marina Cindrić,² Višnja Vrdoljak²

¹Department of Chemistry and Biochemistry, School of Medicine, University of Zagreb, Zagreb, Croatia

²Department of Chemistry, Faculty of Science, University of Zagreb, Zagreb, Croatia

E-mail: danijela.cvijanovic@mef.hr

Hydrazones, versatile ligands with the C=N–N group, and their metal complexes have been in the focus of interest due to applications in various fields, *e.g.* analytical chemistry, catalysis, pharmacy [1,2]. In addition, these types of compounds have diverse biological activities such as cytotoxic activity [3]. However, literature reports on the *in vitro* cytotoxic activity of dioxomolybdenum(VI) complexes with hydrazones are very rare [4].

In this work, dioxomolybdenum(VI) complexes with 4-methoxysalicylaldehyde isonicotinoyl hydrazone (H₂L) were synthesized by the reaction of [MoO₂(acac)₂] and H₂L with the addition of acid (HCl, HBr, HNO₃ or H₂SO₄). The obtained [MoO₂(HL)(MeOH)]X (X = Cl, Br, NO₃, HSO₄) compounds were characterized by elemental and thermogravimetric analysis, IR and NMR spectroscopy, and X-ray diffraction methods (PXRD and SCXRD when suitable). The *in vitro* cytotoxicity of these compounds was investigated on human acute monocytic leukemia (THP-1) and hepatocellular carcinoma (HepG2) cell lines. Each cell line was treated with various concentrations of the tested compounds and the viability of cells after treatment was determined using MTS assay. IC₅₀ values were calculated for all tested compounds from dose-response curves.

In [MoO₂(HL)(MeOH)]⁺, the aroylhydrazone is coordinated to {MoO₂}²⁺ core through the O, N, O donor atoms (Figure 1). All compounds exhibited no cytotoxic activity on HepG2, whereas substantial cytotoxicity on THP-1 cells was observed. Molybdenum(VI) compounds exhibited greater cytotoxicity than the free hydrazone.

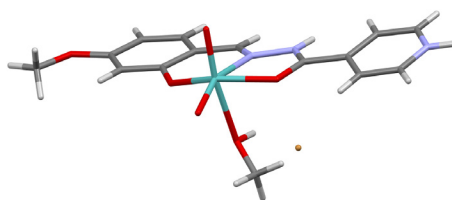

Figure 1: Structure of [MoO₂(HL)(MeOH)]Br.

References

- [1] S. Rollas and S. G. Küçükgülzel, *Molecules* **12** (2007) 1910-1939.
- [2] X. Su and I. Aprahamian, *Chem. Soc. Rev.* **43** (2014) 1963-1981.
- [3] Y. Li, Z. Yang, M. Zhou, Y. Li, J. He, X. Wang and Z. Lin, *RSC Adv.* **7** (2017) 41527-41539.
- [4] T. M. Asha and M. R. Prathapachandra Kurup, *Inorg. Chim. Acta* **483** (2018) 44-52.

Acknowledgment: This work has been supported by Croatian Science Foundation under the project IP-2016-06-4221.

Application of FT4 rheometer in the characterisation of pharmaceutical powder materials

Primjena FT4 reometra u karakterizaciji farmaceutskih praškastih materijala

Dario Klarić, Petar Bibulić, Želimir Jelčić, Helena Cerić
Pliva Hrvatska d.o.o., Zagreb, Croatia

E-mail: dario.klaric01@pliva.com

The flow behavior of pharmaceutical powder materials is relevant in many processes in the pharmaceutical industry because of a need to understand how the powder material flows under different storage and processing conditions. Mechanical methods, such as determination of bulk and tapped densities (BD and TD) and rheometer powder testing, are often used to characterize active pharmaceutical ingredients (API). Powder rheometers can provide fast, repeatable and sensitive measurements with a high degree of automation [1]. The flow properties of a powder are determined by a number of factors including crystal morphology, particle size distribution, compressibility and intra-powder cohesion. A highly cohesive powder will show poor flowability and will be prone to caking, while a non-cohesive powder will flow freely. In case of highly cohesive powders, various excipients can be added to improve the flow properties of a powder. This work shows the characterization of the flow properties of an active pharmaceutical ingredient using FT4 powder rheometer. Also, a study is made into how different amounts and types of excipients and additives affect the pharmaceutical powder flow properties. The effects upon a range of other bulk properties such as bulk density, powder stability, compressibility, and permeability characteristics are also determined and reviewed.

References

[1] R. Freeman, *Powder technol.* **174** (2007) 25-33.

PAH/PAA polyelectrolyte multilayers on silica surface PAH/PAA polielektrolitni višeslojevi na površini silicijeva dioksida

Tin Klačić, Bartol Božić, Davor Kovačević

Division of Physical Chemistry, Department of Chemistry, Faculty of Science, University of Zagreb

E-mail: davor.kovacevic@chem.pmf.hr

Polyelectrolytes are macromolecules composed of substantial portion of the constitutional units which contain ionic or/and ionisable groups. By alternating adsorption of positively and negatively charged polyelectrolytes on a solid surface, polyelectrolyte multilayers are formed. These nanocomposites have interesting properties and are applied in various fields, mainly in biomedicine and pharmacology [1]. Many factors including pH, salt concentration and temperature influence the composition and multilayer structure and in that way designate the properties of polyelectrolyte multilayers. Using the layer-by-layer (LbL) technique PAH/PAA multilayers were formed at silicon dioxide surface (Figure 1). Poly(allylamine hydrochloride), PAH, and poly(acrylic acid), PAA, are weak polyelectrolytes which means that the degree of ionization of these macromolecules depends on pH of solution [2]. That is why the influence of pH on the thickness of each polyelectrolyte layer during the formation of multilayer was monitored by means of ellipsometry. It was found that PAH layers are thinner in the acidic pH region than in the alkaline pH region. The reasons for that are the repulsive interactions between PAH functional groups and the formation of elongated chain conformation of molecules. On the contrary, PAA layers are thicker in the acidic pH region due to the low degree of ionization resulting in “loopy” conformations of PAA molecules. Furthermore, the effects of ionic strength and salt type on the thickness of polyelectrolyte layers were also examined by means of ellipsometry. It seems that the PAH chains prefer binding of weakly hydrated oxyanions. In contrast, the binding of small cations of high charge density appears to be favoured by PAA. This study has shown a way to design a PAH/PAA multilayers of desirable properties and the obtained results could be related to the behaviour of the same polyelectrolyte pair in solution [3].

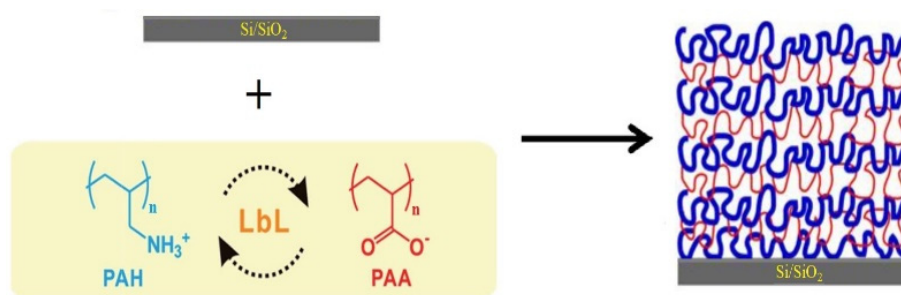

Figure 1: Formation of PAH/PAA polyelectrolyte multilayer on the silicon dioxide surface.

References

- [1] V. A. Izumrudov, B. Kh. Mussabayeva and K. B. Murzagulova, *Russ. Chem. Rev.* **87** (2018) 192-200.
- [2] J. Choi and M. F. Rubner, *Macromolecules* **38** (2005) 116-124.
- [3] T. Kremer, D. Kovačević, J. Salopek and J. Požar, *Macromolecules* **49** (2016) 8672-8685.

Acknowledgment: This research was supported by the Croatian Science Foundation under the project IP-2014-09-6972.

Molecular and crystal structure of polyoxomolybdates built from $[\text{Mo}_7\text{O}_{24}]^{6-}$ and $[\text{CoMo}_6(\text{OH})_6\text{O}_{18}]^{6-}$ anions

Molekulska i kristalna struktura polioksomolibdata građenih od $[\text{Mo}_7\text{O}_{24}]^{6-}$ i $[\text{CoMo}_6(\text{OH})_6\text{O}_{18}]^{6-}$ aniona

Dino Kuzman, Višnja Vrdoljak, Vladimir Stilinović, Marina Cindrić
Sveučilište u Zagrebu, Prirodoslovno-matematički fakultet, Kemijski odsjek, Zagreb

E-pošta: dino.kuzman@chem.pmf.hr

Polioksometalati (POM) predstavljaju veliku skupinu spojeva koja zbog svojih jedinstvenih struktura i interesantnih optičkih, elektronskih i magnetskih svojstava nalazi svoju primjenu u različitim područjima, primjerice kao modelni sustavi u homogenoj i heterogenoj katalizi, u medicini kao antitumorski i antivirusni reagensi, te kao magnetski materijali. Polioksomolibdati predstavljaju jednu od podvrsta POMova čija se kemija istražuje još od sredine 19. stoljeća kada je reakcijom amonijeva molibdata i fosforne kiseline dobiven žuti talog amonijeva fosfomolibdata, $(\text{NH}_4)_6\text{PMo}_{12}\text{O}_{40}$ [1], koji danas nalazi svoju primjenu u analitičkoj kemiji.

Naša novija istraživanja [2] usmjerena su na ispitivanje uvjeta nastajanja kompleksnih soli građenih od (poli)oksomolibdatnog aniona i aminskih kompleksnih kationa kobalta(III) s ciljem definiranja utjecaja makrokationa na proces samoudruživanja. Iz literature [3] je poznato da makrokationske vrste sprječavaju brzu agregaciju polioksomolibdata, stabiliziraju intermedijarne gradivne jedinice i usmjeravaju njihovo samoudruživanje. Polioksomolibdatni anioni, POMo, s kobaltovim(III) makrokationima priređeni su otopinskom sintezom pri a) sobnoj temperaturi, b) povišenoj temperaturi, c) povišenoj temperaturi i tlaku (hidrotermalnom sintezom) i d) mehanokemijskim postupkom potpomognutim otapalom uz reakcije starenja u atmosferi zasićenoj parama vode. Ispitivani su reakcijski uvjeti te prisutnost različitih makrokationa na nastajanje polioksomolibdatnih vrsta. Rezultati su pokazali da ishod reakcije uvelike ovisi o izboru makrokationa odnosno njegovoj sposobnosti za stvaranje vodikovih veza. Izolirane su i okarakterizirane polioksomolibdatne vrste koje sadrže jezgre tipa $\{\text{Mo}_7\text{O}_{24}\}$ i $\{\text{CoMo}_6\text{O}_{24}\}$.

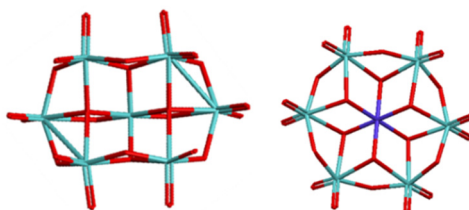

Slika 1: Molekulska struktura $[\text{Mo}_7\text{O}_{24}]^{6-}$ i $[\text{CoMo}_6(\text{OH})_6\text{O}_{18}]^{6-}$ aniona.

Reference

- [1] M. T. Pope, *Heteropoly and Isopoly Oxometalates*, Springer Verlag, Heidelberg, 1983.
- [2] Istraživanje se provodi u okviru HRZZ projekta IP-2016-06-4221 (voditelj. prof. dr. sc. Višnja Vrdoljak).
- [3] S. K. Das, *Macromolecules Containing Metal and Metal-like Elements*, Vol 9, John Wiley & Sons, New York, 2009, 62-120.

Determination of memantine sorption parameters in Croatian soil and sediment samples
Određivanje sorpcijskih parametara memantina u uzorcima tla i sedimenta s teritorija Republike Hrvatske

Dragana Mutavdžić Pavlović¹, Kristina Tolić,¹ Ivan Lukač,¹ Helena Prskalo,¹ Mislav Runje²

¹Faculty of Chemical Engineering and Technology, University of Zagreb, Zagreb, Croatia

²Pliva Croatia TAPI R&D, Zagreb, Croatia

E-mail: dmutavdz@fkit.hr

Human and veterinary pharmaceuticals are known for their great effect and application in the treatment, prevention and suppression of various diseases. The increasing production and use of pharmaceuticals is becoming serious problem due to possible impact on environment and living organisms. The pharmaceuticals are recognized as a new type of pollutants whose fate in environment is little known. Sorption is an extremely important process because of its great influence on pharmaceutical fate in the environment. It mainly depends on the type of solid matrices, physico-chemical properties of chemicals and environment conditions. In this paper, memantine, pharmaceutical used in treating mild to serious Alzheimer's disease, was studied. Since, it has been in use only a few decades, its impact on the environment is still unknown. Therefore, the purpose of this study was to experimentally determine the K_d (soil adsorption coefficient) values of memantine as well as the influence of organic matter on them as expressed by organic carbon-water partition coefficient (K_{OC}), as parameters affecting the binding of the substance to a solid phase in five different natural soil and five different natural sediment samples from the territory of the Republic of Croatia. Sample preparation of soils/sediments and batch sorption experiments were performed according to the OECD 106 Procedure [1]. The effects of contact time, ionic strength, pH and Gibbs free energy on the degree of sorption were also investigated. Sorption phenomena were described using linear, Freundlich and Jovanovich isotherms. The results show that sorption of memantine is spontaneous physical process, best described with the kinetic model of the pseudo-second order. Sorption coefficient, K_d , increased with increasing pH and organic content (%OC) and decreased with increasing ionic strength.

References

[1] OECD, 2000. *Adsorption-desorption using a batch equilibrium method. OECD Guideline for the Testing of Chemicals 106*. OECD, Paris, France

Acknowledgement: This work has been fully supported by Croatian Science Foundation under the project IP-2014-09-2353 „Fate of pharmaceuticals in the environment and during advanced wastewater treatment“.

Test strips for mercury(II) detection based on fluorescent benzimidazole derivatives as optical transducers

Određivanje žive(II) indikatorskim trakicama temeljenim na fluorescentnim derivatima benzimidazola

Ema Horak,¹ Robert Vianello,¹ Nataša Perin,² Marijana Hranjec,² Kristina Bobanović,³
Ivana Murković Steinberg³

¹Computational Organic Chemistry and Biochemistry Group, Ruđer Bošković Institute, Zagreb, Croatia

²Department of Organic Chemistry, Faculty of Chemical Engineering and Technology

³Department of General and Inorganic Chemistry, Faculty of Chemical Engineering and Technology, Zagreb, Croatia

E-mail: Ema.Horak@irb.hr

Novel functional materials based on benzimidazole derivatives are a growing area of research. The structure-related properties of the benzimidazole unit, such as its similarity to naturally occurring nucleotides, electron accepting ability, π -bridging or chromogenic pH sensitivity/switching make it an exceptional structural candidate for the development of multifunctional molecular devices and materials [1]. At the same time, paper test strips are experiencing a major comeback to material science, because of the remarkable progress in wireless and mobile sensing technology and great interest for wearable and easy-to-use sensing materials. Here we present paper test strips for mercury(II) detection based on novel fluorescent benzimidazole derivatives. The optical system behaves like an irreversible chemical sensor – a chemodosimeter – and could thus be used as a single-shot test for the rapid and economic detection of mercury. The benzimidazole derivative is responsible for the formation of the analytical signal, whilst a lipophilic borate anion provides the sensing part of the optode, and is responsible for the detection of mercury ions in the sample. Borate salt decomposes in the presence of mercury ions, and at the same time, the ionic pair comprising the Fluorophore⁺Receptor⁻ disintegrates [2,3]. The mercury(II) sensitive test strips were prepared by drop casting the cocktail composed of fluorophore and anionic borate salt in a plasticised PVC matrix onto paper substrate. The mechanism of sensing activity, linear range, response time, and the stability of this novel functional material is characterised by UV-visible fluorescence spectrophotometry. This work was funded by the Croatian Science Foundation (project HRZZ-3386, iNFInITE-SENS).

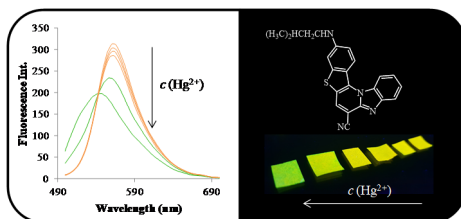

Figure 1: Hg²⁺ fluorescence response of paper test strips based on BI derivative, $c(\text{Hg}^{2+}) = 5 \cdot 10^{-4}$ to $5 \cdot 10^{-8}$ M.

References

- [1] E. Horak, P. Kassal and I. Murković Steinberg, *Supramol. Chem.* **30** (2018) 838-857.
- [2] I. Murković and O. S. Wolfbeis, *Sens. Actuators, B* **39** (1997) 246-251.
- [3] C. Cano-Raya, M. D. Fernández-Ramos, J. Gómez-Sánchez and L. F. Capitán-Vallvey, *Sens. Actuators, B* **117** (2006) 135-142.

Complexation of lanthanides by aroylhydrazones derived from nicotinic acid hydrazide: spectrophotometric determination

Kompleksiranja lantanoida aroilhidrazonima izvedenim iz nikotinohidrazida: spektrofotometrijsko određivanje

Franciska Grgić,¹ Hana Rimanić,¹ Marijana Pocrnić,¹ Darko Kontrec,²
Ana Budimir,³ Nives Galić¹

¹Kemijski odsjek, Prirodoslovno-matematički fakultet, Sveučilište u Zagrebu, Zagreb, Hrvatska

²Zavod za organsku kemiju i biokemiju, Institut Ruđer Bošković, Zagreb, Hrvatska

³Farmaceutsko-biokemijski fakultet, Sveučilište u Zagrebu, Zagreb, Hrvatska

E-pošta: franciska.grgic@gmail.com

Mnogi aroilhidrazoni grade stabilne, obojene komplekse s različitim ionima prijelaznih metala i lantanoida te se primjenjuju kao analitički reagensi [1]. Lantanoidi se zbog svojih svojstava često koriste u terapijske i dijagnostičke svrhe, a manje su toksični ukoliko se primjenjuju vezani u komplekse [2]. Zbog moguće primjene u medicini/dijagnostici istražuje se kompleksiranje lantanoida različitim klasama spojeva, između ostalog i hidrazonima. U ovom radu spektrofotometrijski je praćeno vezanje odabranih lantanoida (lantana, europija, gadolinija i iterbija) derivatima aroilhidrazona izvedenim iz nikotinohidrazida (Slika 1). U acetonitrilu trenutno nastaju kompleksi sa svim navedenim ligandima, ali su samo oni s ligandima **1** i **3** stabilni tijekom vremena. Stoga su spektrofotometrijske titracije sa spojevima *N'*-saliciliden-3-piridinkarbohidrazid (**1**) i *N'*-(2-hidroksi-4-metoksifenilmetiliden)-3-piridinkarbohidrazid (**3**) provedene direktno u kivetu. Pri danim eksperimentalnim uvjetima otopine hidrazona i metalnih soli ne apsorbiraju u području karakterističnom za apsorpciju novonastalih kompleksa ($\lambda_{\max} \sim 400$ nm). Metodom kontinuirane varijacije određeni su stehiometrijski omjeri metala i pojedinih aroilhidrazona u kompleksu, a na temelju rezultata spektrofotometrijskih titracija pripadne konstante stabilnosti. Vrijednosti logaritma konstanti vezanja za komplekse sastava 1:1 nalaze se u rasponu od $\lg K = 4,05$ za kompleks La**1** do $\lg K = 4,94$, određen za kompleks sastava Eu**3**. Međutim, za kompleks nastao reakcijom iterbija(III) sa spojem **3** nije bilo moguće jednoznačno odrediti sastav kompleksa, a time ni odgovarajuću konstantu stabilnosti.

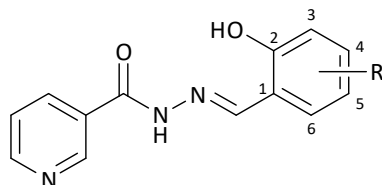

Slika 1: Strukture aromatskih hidrazona: R = H (**1**); 3-OCH₃ (**2**); 4-OCH₃ (**3**); 5-OCH₃ (**4**).

Reference

- [1] L. N. Suvarapu, Y. K. Seo, S. O. Baek i V. R. Ammireddy, *E-J. Chem.* **9** (2012) 1288-1304.
[2] B. Moksharagni i K. H. Reddy, *Eur. J. Biomed. Pharm. Sci.* **5** (2018) 810-817.

Napomena: Istraživanje je financirano od strane Hrvatske zaklade za znanost (projekt IP-2014-09-4841).

Lipase-catalyzed synthesis of sugar fatty acid esters: study of the reaction conditions through a DoE approach
Lipazama katalizirana sinteza estera masnih kiselina: istraživanje uvjeta reakcije primjenom DoE pristupa

Giovanna Speranza,¹ Kalliopi Avramidou,¹ Giuseppe Cappelletti,¹ Denise Cavuoto,¹ Carlo F. Morelli,¹ Davide Rosa,¹ Sara Sangiorgio,¹ Teodora Bavaro,² Giorgio Marrubini,² Daniela Ubiali²

¹Department of Chemistry, University of Milan, Milan, Italy

²Department of Drug Sciences, University of Pavia, Pavia, Italy

E-mail: giovanna.speranza@unimi.it

Sugar fatty acid esters (SFAEs), usually called sugar esters, are non-ionic surfactants which are characterized by excellent emulsifying, stabilizing and detergency properties. SFAEs are widely used in many market sectors (*i.e.* food, detergent, cosmetic and pharmaceutical industry); depending on carbon chain length and nature of the sugar head group, SFAEs cover a wide range of hydrophilic-lipophilic balance (HLB). SFAEs have many advantages over petrochemical-derived surfactants as they are neither harmful to the environment nor skin irritants, are fully biodegradable and non-toxic. More interestingly, they can be produced from renewable resources [1].

Chemical synthesis of SFAEs requires harsh reaction conditions, which result in most cases, in complex mixtures of monoesters, di- or triester isomers, and by-products. Enzyme-based synthesis is an alternative strategy that can overcome the above mentioned drawbacks: enzymatic reactions occur under milder conditions and do not generally require tedious protection/deprotection steps. Moreover, biotransformations provide more environmentally friendly synthetic routes. Sugar fatty acid esters can be prepared, indeed, through an esterification reaction between a sugar ($C_n(H_2O)_n$) and a fatty acid (RCO_2H) catalyzed by a lipase [2-4].

In this work, SFAEs, including glucose monooleate (GluMO), monostearate (GluMS), monopalmitate (GluMP), monolaurate (GluML), and galactose monooleate (GaMO), monostearate (GaMS), monopalmitate (GaMP), monolaurate (GaML), were synthesized by enzymatic esterification of fatty acids and the corresponding sugar. Immobilized lipases were used to catalyze this reaction in organic solvent by using molecular sieves (4 Å) to scavenge the water by-product and thus shift the reaction towards sugar ester formation. Reaction yields and product characterization were assessed by ¹H-NMR.

Rational design of enzymatic reactions was carried out by using the synthesis of GluMP as the model reaction. Sugar:fatty acid ratio, temperature, and reaction time were selected as variables (response: product yield).

References

- [1] N. S. Neta, J. A. Texteira and L. R. Rodrigues, *Crit. Rev. Food Sci. Nutr.* **55** (2015) 595-610.
- [2] N. Sarmah, D. Revathi, G. Sheelu, K. Yamuna, Rani, S. Sridhar, V. Mehtab and C. Sumana, *Biotechnol. Prog.* **34** (2018) 5-28.
- [3] M. Enayati, Y. Gong, J. M. Goddard and A. Abbaspourrad, *Food Chem.* **266** (2018) 508-513
- [4] K. Ren and B. P. Lamsal, *Food Chem.* **214** (2017) 556-563 and refs therein.

Complexation of homocyclopeptides with halides and oxoanions in acetonitrile and dimethyl sulfoxide

Kompleksiranje homociklopeptida s halogenidima i oksoanionima u acetonitrilu i dimetilsulfoksidu

Gordan Horvat,¹ Siniša Tarana,¹ Nikolina Vidović,² Nikola Cindro,¹ Giovanna Speranza,² Vladislav Tomišić¹

¹Department of Chemistry, Faculty of Science, University of Zagreb, Zagreb, Croatia

²Università degli Studi di Milano, Milan, Italy

E-mail: ghorvat@chem.pmf.hr

Cyclopeptides are promising class of anion receptors owing to the spatial proximity of backbone amide groups and also to the variety of sidechain substituents that can affect the receptor properties [1-3]. Complexation affinities of three cyclopeptide derivatives (Figure 1) for halide ions, thiocyanate and oxoanions were studied in acetonitrile and dimethyl sulfoxide. Ligand **L1** is a pentaleucine cyclopeptide derivative whereas the other two cyclopeptidic ligands are comprised of lysine subunits protected by *tert*-butylcarbonyl (BOC) group. Ligand **L2** is built out of four such subunits whereas ligand **L3** contains five of them. Stability constants of **L1**, **L2** and **L3** complexes with studied anions were determined by means of microcalorimetric and ¹H NMR titrations. To get more detailed insight into the binding of anions by the investigated cyclopeptide derivatives, classical molecular dynamics simulations were carried out.

The ligands showed larger affinity for all anions in acetonitrile than in dimethyl sulfoxide. It was found that the stability of the anion complexes of pentameric compounds **L2** and **L3** was higher when compared to the complexes of tetrameric ligand **L1**. The results of ¹H NMR titrations and molecular dynamics simulations indicated that the bound anions were coordinated by the amide groups of cyclopeptide receptors. In the case of **L1** and **L2** complexes with H₂PO₄⁻ anion, the participation of carbamate protons in the anion coordination was observed.

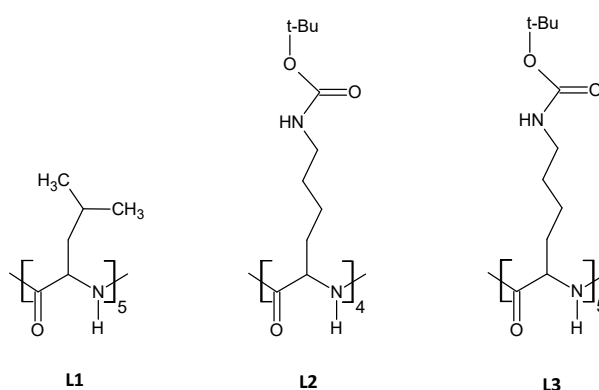

Figure 1: Structures of cyclopeptide ligands.

References

- [1] S. Kubik, *Acc. Chem. Res.* **50** (2017) 2870-2878.
- [2] R. B. P. Elmes and K. A. Jolliffe, *Chem. Commun.* **51** (2015) 4951-4968.
- [3] P. A. Gale, *Chem. Commun.* **47** (2011) 82-86.

How hydrophobicity modulates amino acid discrimination by isoleucyl-tRNA synthetase?

Kako hidrofobnost utječe na diskriminaciju izoleucil-tRNA-sintetaze prema aminokiselinama?

Igor Živković, Ita Gruić-Sovulj

Department of Chemistry, Faculty of Science, University of Zagreb, Zagreb, Croatia

E-mail: izivkovic@chem.pmf.hr

Hydrophobic effect is considered as the main driving force for binding of small molecules to proteins. To investigate how hydrophobicity affects substrate binding and its catalysis, we used isoleucyl-tRNA synthetase (IleRS) as a model enzyme. IleRS activates (Figure 1, (1)) isoleucine (Ile) and transfers it to tRNA^{Ile} (Figure 1, (2)) for participation in protein synthesis. IleRS can also misactivate non-cognate valine (Val) and norvaline (Nva), both being one methylene group smaller than Ile, and transfer them to tRNA^{Ile}. To prevent accumulation of misacylated tRNAs, and thus error in protein synthesis, IleRS employs pre- and post-transfer hydrolytic editing (Figure 1, orange/red). To tackle how substrate's hydrophobicity modulates specificity of IleRS, we analysed aminoacylation and editing of α -aminobutyrate (α -ABA) – two methylene groups smaller amino acid than Ile.

We found that IleRS activated α -ABA and transferred it to tRNA^{Ile} with the similar rate constants as it does with Ile. Discrimination against α -ABA was, however, exercised at the level of K_m , which is 3500-times greater than the K_m for activation of Ile. Yet, even at high concentrations of α -ABA there was no accumulation of α -ABA-tRNA^{Ile}. We showed that it is a consequence of fully active IleRS pre- and post-transfer editing against α -ABA. Thus, decrease in hydrophobicity disturbs binding of amino acids to IleRS (K_m effect) while the chemical steps in the synthetic and editing sites remain almost unaffected.

To explore how fluorine-dependent increase in hydrophobicity affects amino acid binding and/or catalysis, we tested di- and tri- γ -fluorinated analogues of α -ABA in the reactions of IleRS (Figure 1, (1)-(5)). Interestingly, fluorination had little or no effect on the K_m in activation, suggesting that, in the case of IleRS, fluorine atoms cannot compensate the loss of hydrophobic interactions caused by decreased size of α -ABA. On the other hand, fluorination reduced the rate of α -ABA activation (Figure 1, (1)) up to 5-fold and had no effect on post-transfer editing reaction of α -ABA-tRNA^{Ile} (Figure 1, (5)). Also, our data suggest that "polar hydrophobicity", a peculiar feature of fluorine, may produce adverse effect on the interactions of fluorinated substrates with proteins. Hence, the complexity of predicting those interactions could make reengineering of aminoacyl-tRNA synthetases, for the purpose of more efficient incorporation of fluorinated amino acids into proteins, highly challenging.

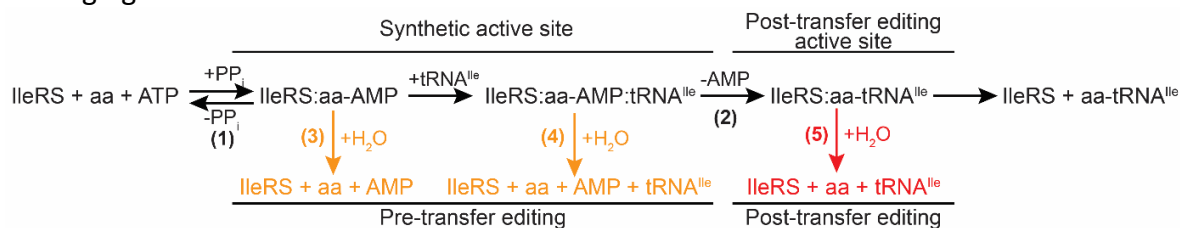

Figure 1: Isoleucyl-tRNA synthetase pathways of aminoacylation and editing.

The supramolecular complexes between bis-pyridinium-4-oxime and distinctive cyanoiron platforms

Supramolekulski kompleksi između bis-piridinij-4-oksima i različitih cijanoferat-platformi

Igor Picek,¹ Blaženka Foretić,¹ Ivana Furač², Dubravka Matković-Čalogović³

¹Department of Chemistry and Biochemistry, School of Medicine, University of Zagreb, Zagreb, Croatia

²Department of Forensic Medicine, School of Medicine, University of Zagreb, Zagreb, Croatia

³Department of Chemistry, Faculty of Science, University of Zagreb, Zagreb, Croatia

E-mail: ipicek@mef.hr

The inter-ionic metallo-organic hybrid materials are interesting systems because of the opportunity to obtain a synergy of distinctive properties of both components combined into one supramolecular assembly with new optical and electrochemical properties. Recently, mono- and bis-pyridinium-4-oxime were recognized as electron acceptors for the formation of colored, supramolecular, inter-ionic charge-transfer complexes with hexacyanoferrate(II) as a donor [1]. Herein, the bis-pyridinium-4-oxime cation, toxogonin (TOXO), as the most potent electron acceptor, is used for construction of a new type material containing hexacyanoferrate or nitroprusside anionic platform. The crystal structures of two complexes, (TOXO)₂[Fe^{II}(CN)₆] \cdot 3.5H₂O (Figure 1) and (TOXO)[Fe^{II}(CN)₅(NO)] \cdot 3H₂O, are resolved, yielding valuable insights into the interactions responsible for the supramolecular complex assembly. The solvent- or temperature-induced dehydration of (TOXO)₂[Fe^{II}(CN)₆] \cdot 3.5H₂O results in the loss of crystallinity and the irreversible color change, indicating the molecular-level charge-transfer perturbation. In this work, the supramolecular chemistry of the photochromic nitroprusside anion has been extended to its association with the biologically active and pharmacologically important ligand. The formation of the supramolecular (TOXO)[Fe^{II}(CN)₅(NO)] assembly in aqueous solution is monitored by the UV/Vis and ¹H-NMR spectroscopy. The optical and structural properties of the complexes are provided employing FT-IR, Mössbauer and diffuse reflectance spectroscopy. The color, composition and spectroscopic analysis of the complexes provide insights into binding of the cationic and anionic counterparts.

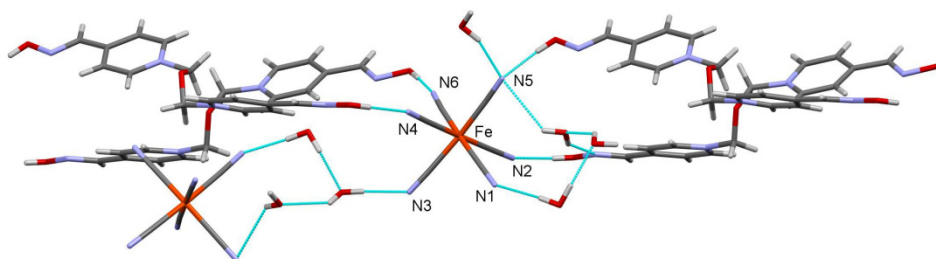

Figure 1: Hydrogen bonding pattern in the structure of (TOXO)₂[Fe^{II}(CN)₆] \cdot 3.5H₂O.

References

- [1] B. Foretić, R. Vianello, D. Matković-Čalogović, D. Jadreško, I. Picek, *New J. Chem.* **42** (2018) 16115-16126.

**Activity improvements of quinuclidinium compounds based on
multivariate data analysis**
**Poboljšanje aktivnosti kinuklidinskih spojeva temeljeno na multivarijantnoj
analizi podataka**

Ines Primožič, Karlo Sović, Tomica Hrenar

Department of Chemistry, Faculty of Science, University of Zagreb, Zagreb, Croatia

E-mail: ines.primozic@chem.pmf.hr

In vitro antibacterial activity determined previously for quinuclidinium compounds was used as a base for independent explanatory variables in establishing activity/structure model. To evaluate and quantify activities of these compounds and make connection to their molecular structures, multivariate analysis of the obtained antibacterial activity data was performed [1,2]. In addition, theoretical calculations of potential energy surfaces were carried out for all compounds [2]. 1D, 2D and 3D-potential energy surfaces were calculated by varying values of selected torsional angles around relevant chemical bonds. By performing the search of multidimensional potential energy surfaces, full conformational analysis of all compounds was performed. These multidimensional surfaces of energy data were then decomposed using the multi-way numerical procedures within TUCKER models. Using the data from reduced space of antibacterial activities and data from reduced space of potential energy surfaces, a multilinear model connecting the theoretical investigation and measured antibacterial activities was established. Obtained multilinear activity/structure model comprised the information on energetics and activities for all the investigated compounds and it was used for the possible prediction of structure modifications. Using these predictions, the structural patterns important for antimicrobial activities were identified and used for further improvements, founding a process of an iteratively guided design for new quinuclidinium compounds driven by antibacterial activity and theoretical data.

References

- [1] A. Bosak, A. Ramić, T. Šmidlehner, T. Hrenar, I. Primožič and Z. Kovarik, *PLoS ONE* **13** (2018) e0205193.
[2] M. Skočibušić, R. Odžak, A. Ramić, T. Smolić, T. Hrenar and I. Primožič, *Molecules* **23** (2018) 1212 1-13.

Sintering of silver nanoink deposited on flexible substrate by conventional thermal method

Termalno sinteriranje vodljive tinte temeljene na nanočesticama srebra otisnute na fleksibilnoj podlozi

Irena Ivanišević, Petar Kassal, Andrea Milinković, Anamarija Rogina, Stjepan Milardović
Faculty of Chemical Engineering and Technology, University of Zagreb, Croatia

E-mail: ivanisevic@fkit.hr

Due to their unique optical, electrical and thermal properties, silver nanoparticles (AgNP) have become the prominent material for application in various research fields, such as catalysis, biotechnology, optics and electronics [1,2]. In the case of flexible electronics, inkjet printing of nanosilver ink represents an attractive technology for precise deposition of conductive substance on different polymeric substrates. Electrical conductivity, a key factor in measuring performance of printed electronics, greatly depends on post-fabrication sintering process [3]. Thus, formulation of a stable AgNP colloidal suspension, which allows easy removal of the grain-stabilizing agent in slightly elevated temperatures to produce electrically conductive material is required.

In this work, two novel conductive inks were synthesized – both based on silver nanoparticles, but stabilized with two distinctive capping agents – Poly(acrylic acid) (PAA) and Poly(methacrylic acid) (PMA), respectively. Nanoinks were inkjet printed on flexible PET substrates and thermally treated in order to produce conductive bulk silver patterns. Combination of parameters such as width, length and thickness of the printed lines, temperature conditions ranging from room to elevated values, and sintering time were studied. It has been shown that the silver lines with best conductivity measurements were generated at temperatures above 100 °C, regardless of the type of capping molecule. Also, minimum of 200 μm line width was needed to obtain conductivity of printed electrode.

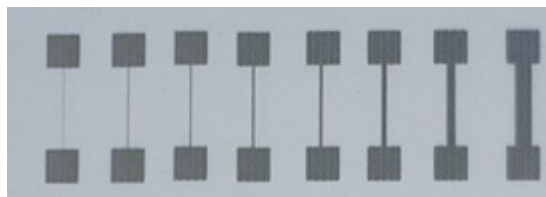

Figure 1: Inkjet-printed silver electrodes of various width.

References

- [1] I. Fratoddi, *Nanomaterials* **8** (2018) 1-25.
- [2] X. F. Zhang, Z. G. Liu, W. Shen and S. Gurunathan, *Int. J. Mol. Sci.* **17** (2016) 1-34.
- [3] Y. Mou, Y. Zhang, H. Cheng, Y. Peng and M. Chen, *Appl. Surf. Sci.* **459** (2018) 249-256.

Development of ultra performance liquid chromatographic method for the analysis of Dasatinib degradation products

Razvoj metode tekućinske kromatografije ultravisoke djelotvornosti za analizu razgradnih produkata lijeka dasatiniba

Irena Radić,¹ Zlata Lasić,¹ Davor Šestan,² Nives Galić²

¹Pliva Croatia Ltd., Zagreb, Croatia

²Faculty of Science, University of Zagreb, Zagreb, Croatia

E-mail: irena.radic01@pliva.com

Dasatinib is active pharmaceutical ingredient used to treat a certain type of chronic myeloid leukemia (CML). Impurities in pharmaceutical product are the unwanted chemical compounds that remain within the active pharmaceutical ingredient (API), or are formed during production process or by degradation of API. The presence of these unwanted chemical compounds even at small concentrations may influence the efficacy and safety of the pharmaceutical products. Degradation products can be potentially genotoxic, mutagenic or carcinogenic, thus needing constant monitoring and impurity profiling.

In this study efficient ultra-high performance liquid chromatography (UHPLC) method for determination of impurities and degradation products of Dasatinib was developed. DryLab, commercial software for UHPLC method development, was used to determine the optimal conditions for UHPLC separation like temperature, time of gradient elution and composition of the mobile phase. DryLab enabled prediction of retention times in dependence of method parameters from 12 preliminary experiments. The obtained optimal method conditions were checked and mathematical model was confirmed by experiments. Dasatinib was subjected to forced degradation under the following conditions: hydrolysis, photolysis, oxidation, dry and wet heat, all in accordance with the International Conference on Harmonization [1,2]. Degradation products were analyzed by LC-MS/MS system. Based on the MS and MS/MS spectra, the structures of degradation products, as well as fragmentation schemes were proposed [3].

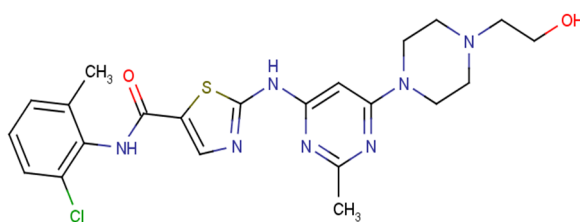

Figure 1: Chemical structure of Dasatinib.

References

- [1] International Conference on Harmonisation, *Stability Testing of New Drug Substances and Products* Q1A (R2), IFPMA, Geneva, 2003.
- [2] International Conference on Harmonisation, *Photo Stability Testing of New Drug Substances and Products*, Q1B, IFPMA, Geneva, 1996.
- [3] Davor Šestan, *Development of ultra performance liquid chromatographic method for the analysis of dasatinib degradation products* – Diploma Thesis, Faculty of Science, University of Zagreb, Zagreb, 2017.

LC-SPE/NMR analysis of macrozones, new bioactive azithromycin conjugates Analiza makrozona, novih bioaktivnih konjugata azitromicina, tehnikom LC-SPE/NMR

Iva Habinovec,¹ Noelle Benčić,¹ Mirjana Bukvić,² Ivan Grgičević,² Ivana Mikulandra,¹
Tomislav Jednačak,¹ Predrag Novak¹

¹Department of Chemistry, Faculty of Science, Zagreb, Croatia

²Fidelta d.o.o., Zagreb, Croatia

E-mail: ihabinovec@chem.pmf.hr

Azithromycin belongs to an azalide subclass of 15-membered macrolide antibiotics. With a much improved pharmacokinetic and therapeutic properties over erythromycin, azithromycin became the most widely used broad-spectrum antibiotic [1].

An increasing number of antibiotic-resistant bacteria, especially respiratory tract pathogens, demand a more effective antimicrobial agents to be synthesized [2]. Thiosemicarbazones belong to a large group of thiourea derivatives and are well known as antibacterial, antiviral, anti-inflammatory, antifungal and anticancer therapeutics [3]. Conjugation of the azithromycin analogue, 9a-(γ -aminopropyl) derivative, and thiosemicarbazone moieties resulted in novel compounds, macrozones, which showed good *in vitro* activity against selected Gram positive and Gram negative bacterial strains.

Modern approach to the impurity profiling of bioactive compounds is based on the use of hyphenated systems, such as LC-NMR and/or LC-MS [4-6]. One of the most efficient and powerful tools for on-line isolation and identification of compounds in complex mixtures in the pharmaceutical industry is the LC-SPE-NMR system [6-7]. In this study, LC-SPE/NMR technique was used for impurity profiling of the novel macrozones.

References

- [1] B. Arsić, P. Novak, M. G. Rimoli, J. Barber, G. Kragol and F. Sodano, *Macrolides: Properties, Synthesis and Applications*, De Gruyter, Berlin, 2018.
- [2] M. Bukvić Krajačić, M. Dumić, P. Novak, M. Cindrić, S. Koštrun, A. Fajdetic, S. Alihodžić, K. Brajša and N. Kujundžić, *Bioorg. Med. Chem. Lett.* **21** (2011) 853-856.
- [3] M. A. Soares, M. A. Almeida, C. Marins-Goulart, O. A. Chaves, A. Echevarria and M. C. C. Oliveira, *Bioorg. Med. Chem. Lett.* **27** (2017) 3546-3550.
- [4] P. Novak, P. Tepeš, M. Ilijaš, I. Fistrić, I. Bratoš, A. Avdagić, V. Gabelica Marković and M. Dumić, *J. Pharm. Biomed. Anal.* **50** (2009) 68-72.
- [5] S. Görög, *Trends Anal. Chem.* **101** (2018) 2-16.
- [6] I. Habinovec, T. Jednačak and P. Novak, *ADMET & DMPK* **3** (2015) 352-358.
- [7] M. Harča, I. Habinovec, E. Meštović, I. Biljan and P. Novak, *Croat. Chem. Acta* **89** (2016) 543-547.

Impact of the supramolecular organisation of pyrene–quinoline conjugates on their interaction with ds-DNA

Utjecaj supramolekulske organizacije konjugata piren-kinolina na njihovu interakciju s DNA

Iva Orehovec,¹ Danijel Glavač,² Irena Dokli,³ Matija Gredičak,² Ivo Piantanida¹

¹Laboratory for Biomolecular Interactions and Spectroscopy, Division of Organic Chemistry and Biochemistry, Ruđer Bošković Institute, Zagreb, Croatia

²Laboratory for Biomimetic Chemistry, Division of Organic Chemistry and Biochemistry, Ruđer Bošković Institute, Zagreb, Croatia

³Laboratory for Stereoselective Catalysis and Biocatalysis, Division of Organic Chemistry and Biochemistry, Ruđer Bošković Institute, Zagreb, Croatia

E-mail: iorehov@irb.hr

Two novel pyrene–quinoline conjugates differing in the linker flexibility between aryls were prepared. In comparison with referent pyrene derivative, both conjugates showed intramolecular pyrene–quinoline stacking in aqueous medium, much more efficient for the rigid conjugate. Consequently, only the rigid conjugate showed excimer fluorescence with exceptionally strong bathochromic shift (+ 55 nm) of emission maximum in respect to the referent pyrene analogue and flexible conjugate. All studied compounds showed similar, 10 $\mu\text{mol dm}^{-3}$ affinity toward ds-DNA, characterised in general by fluorescence quenching. The flexible conjugate showed the formation of pyrene–quinoline excimer only at large excess of DNA, while the rigid conjugate retained excimer emission over all DNA concentrations. The lack of significant thermal stabilisation of ds-DNA by the studied compounds together with the minor changes in CD spectrum of DNA pointed to the non-specific agglomeration of both conjugates and referent pyrene analogue within hydrophobic DNA grooves as the dominant binding mode.

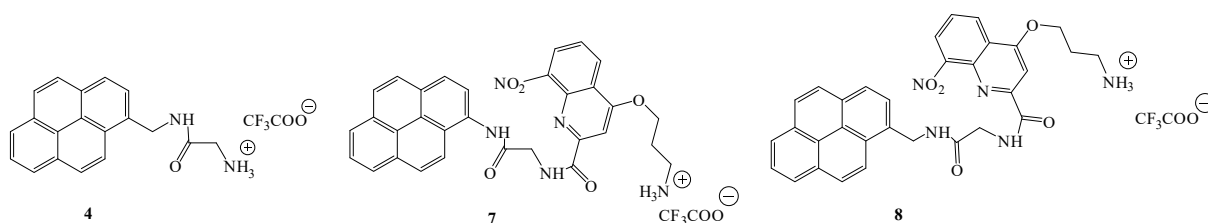

Figure 1: Novel pyrene – quinoline conjugates **7**, **8** and referent pyrene analogue **4**.

References

[1] I. Orehovec, D. Glavač, I. Dokli, M. Gredičak and I. Piantanida, *Croat. Chem. Acta* **90** (2017) 603-611.

Application of modified carbon electrode for voltammetric determination of heavy metals in honey
Primjena modificirane ugljikove elektrode za voltametrijsko određivanje teških metala u medu

Ivana Škugor Rončević,¹ Nives Vladislavić,¹ Ana Boban,² Ljubica Bosnić,² Marijo Buzuk,¹ Maša Buljac³

¹Zavod za opću i anorgansku kemiju, Kemijsko-tehnološki fakultet, Sveučilište u Splitu, Hrvatska

²Kemijsko-tehnološki fakultet, Sveučilište u Splitu, Hrvatska

³Zavod za kemiju okoliša, Kemijsko-tehnološki fakultet, Sveučilište u Splitu, Hrvatska

E-pošta: skugor@ktf-split.hr

Med se od davnina koristi u ljudskoj prehrani i oduvijek je bio vrlo cijenjen zahvaljujući svojim nutritivnim i ljekovitim svojstvima. Zahvaljujući razvoju industrije i velikom porastu uporabe mehanizacije pogonjene naftom i derivatima, u medu je osobito u zadnjih 20 godina primijećen veliki porast sadržaja teških metala u blizini frekventnih prometnica, gdje se teški metali apsorbiraju u tlo, atmosferu i vodu te posljedično u biljke. Iz navedenog je vidljivo kako sadržaj minerala i metala u uzorcima meda može dati naznaku zemljopisnog podrijetla meda i poslužiti kao odličan biomarker zagađenja okoliša.

U radu je predložena metodologija za određivanje teških metala (Cu, Pb i Cd) u zaslađivačima (medu i šećeru) primjenom pravokutnovalne voltametrije na elektrodi od staklastog ugljika (GC) modificiranoj filmom hidroksiapatita (HAp). HAp-film formiran je kronoamperometrijski, dok su njegove osobine kao i mogućnost primjene za elektroanalitičko određivanje teških metala ispitane voltametrijskim metodama (ciklička voltametrija, pravokutnovalna voltametrija). HAp zbog svoje visoke poroznosti ima sposobnost prihvaćanja drugih iona kao supstituenata. Predložena jednostavna metoda formiranja HAp-filma rezultira povećanjem osjetljivosti GC elektrode, a dobra ponovljivost, niska granica određivanja bez značajnih utjecaja ostalih konstituanata u medu čine predloženu metodu primjenljivom u analitičke svrhe.

***Salvia officinalis* L. – a small factory of compounds. Variations among individuals**

***Salvia officinalis* L. – mala tvornica spojeva. Varijacije među jedinkama**

Mateo Glumac, Zvonimir Jažo, Josip Radić, Glorija Granić, Franka Folo, Ivana Drventić
Kemijsko-tehnološki fakultet, Sveučilište u Splitu, Split, Republika Hrvatska

E-pošta: glogranic@gmail.com, f_folo@hotmail.com, ivana.drventic@gmail.com

Salvia officinalis ili kadulja iz porodice Lamiaceae je višegodišnja niska grmolika biljka karakteristična za zemlje mediteranskog bazena. Znanstvena istraživanja dokazuju kako porodica obuhvaća više od 900 različitih vrsta [1]. Posebnu uporabu ima u prehrambenoj industriji kao konzervans i antioksidans. Zbog širokog spektra antioksidacijskih spojeva, ulje kadulje koristi se kao zamjena za sintetske antioksidanse kao što je butilirani hidroksitoluen, a antioksidacijsko i inhibirajuće djelovanje kadulje na pojedine bakterijske vrste razlog je širokoj uporabi ulja kadulje i u farmaceutskoj industriji [1].

U rujnu 2018. na području srednje Dalmacije prikupljeno je sedam uzoraka kadulje izvan sezone cvatnje. Uzorkovani su gornji dijelovi biljaka koji su osušeni i pripremljeni za analizu sadržanih isparljivih spojeva. Izolacija isparljivih spojeva provedena je hidrodestilacijom u aparaturi izvedbe Clevenger. Zbog smanjenja gubitaka isparljivih spojeva i što većeg prinosa ulja iz biljke korišten je pentanska zamka.

GC/MS (engl. *gas chromatography/mass spectrometry*) analizom identificirane su 24 kemijske komponente koje, prosječno, zajedno čine 96 % ukupne mase eteričnog ulja kadulje. Eterična ulja dalmatinske kadulje cijenjena su u svijetu zbog niskog udjela kamfora (<20 %) te visokog udjela α - i β -tujona (2), a to potvrđuju dobiveni eksperimentalni podatci. Udio kamfora iznosi prosječno 21,1 % dok se u većoj količini nalazi α -tujon s prosječno 24,1 % na sedam analiziranih uzoraka. Sama pojava veće količine kamfora pokazuje minimalna odstupanja od očekivanih što se može objasniti činjenicom da kadulja nije brana za vrijeme sezone cvata kada je udio kamfora najniži. Količina α -tujona najniža je za vrijeme cvata biljke dok su visoke vrijednosti karakteristične za kraj ljeta te u jesen i zimu kada su zabilježeni rezultati >40 % [2]. 1,8-cineol čini prosječno 9,3 % sastava ulja što odgovara očekivanim vrijednostima prinosa (3 – 12 %). Sama količina 1,8-cineola najviša je u vrijeme cvata kadulje [2]. Razina viridiflorola (prosječno 7 %) veoma je visoka u odnosu na pronađene razine kod drugih autora. Komponente s prosječnom vrijednosti nešto višom od 6 % ukupne količine ulja su kamfen, β -tujon i α -pinen, dok su udjeli ostalih spojeva zanemarivo mali.

Uz GC/MS analizu, uzorci su istraženi i skenirajućim elektronskim mikroskopom (SEM), a rezultati su prikazani u radu u obliku SEM fotografija.

Reference

[1] A. Porte, R. L. O. Godoy i L. H. Maia-Porte, *Rev. Bras. Pl. Med.* **15** (2013) 438-441.

[2] B. P. Nigel, R. E. Anderson, N. J. Brennan, M. H. Douglas, A. J. Heaney, J. A. McGimpsey i B. M. Smallfield, *J. Agric. Food Chem.* **47** (1999) 2048-2054.

Synthesis of C-glycosyl amino acids by post-condensation modification of Passerini products

Priprava C-glikozil aminokiselina post-kondenzacijskom modifikacijom Passerinijevih produkata

Ivana Kovačić, Katarina Vazdar, Ivanka Jerić
Institut Ruđer Bošković, Zagreb, Hrvatska

E-pošta: ivana.kovacic@irb.hr

Višekomponentne reakcije (engl. *multicomponent reactions*, MCRs) predstavljaju efikasnu metodu za uvođenje kemijskih različitosti i stvaranje biblioteka malih molekula. Osnovni princip MCRs je stvaranje relativno složene strukture iz jednostavnih polaznih spojeva u jednom reakcijskom stupnju. Mnoge MCRs koje se temelje na reakciji izocijanidne skupine (engl. *isocyanide-based MCRs* – IMCRs) odvijaju se u blagim reakcijskim uvjetima u prisutnosti različitih funkcionalnih skupina. Passerinijeva i Ugijeva reakcija su posebno važne reakcije u skupini IMCRs, jer daju peptidima slične produkte-peptidomimetike, koji mogu oponašati strukturu i funkciju prirodnih peptida i proteina.

Passerinijevom reakcijom koja uključuje korištenje ugljikohidratnih aldehida dobiveni su α -aciloksi amidi koje nose ugljikohidratnu komponentu direktno vezanu na novi kiralni centar [1]. Post-kondenzacijskim modifikacijama Passerinijevih i Ugijevih produkata moguće je pripremiti nove, još složenije strukture. Hidrolizom u baznim uvjetima dobiveni su derivati ugljikohidratnih α -hidroksi kiselina. Takvi derivati su vrlo vrijedni monomeri, koji će se koristiti u sintezi peptidomimetika. Ugljikohidratni peptidomimetici imaju potencijalnu primjenu u barem dva područja: medicinska kemija (interakcija proteina i oligosaharida) i supramolekulska kemija (samoudruživanje, formiranje različitih oblika nanostrukture).

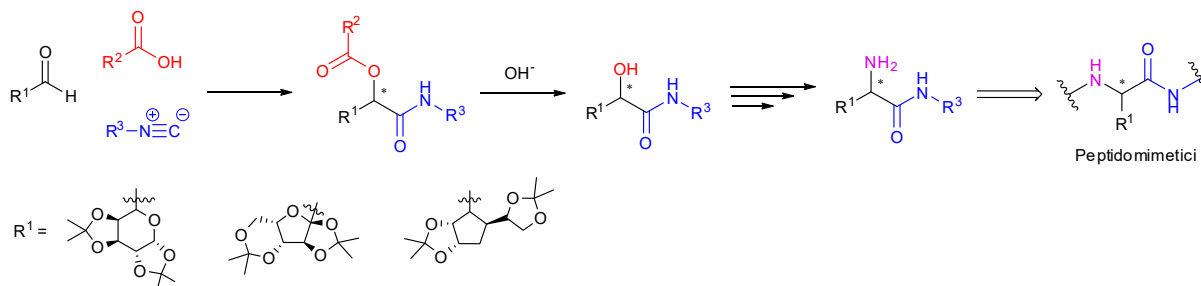

Slika 1: Shematski prikaz dobivanja ugljikohidratnih peptidomimetika.

Reference

[1] K. Vlahoviček-Kahlina, M. Vazdar, A. Jakas, V. Smrečki i I. Jerić, *J. Org. Chem.* **83** (2018) 13146-13156.

Synthesis and characterization of macrozones, new bioactive azithromycin conjugates

Priprava i karakterizacija makrozona, novih bioaktivnih konjugata azitromicina

Ivana Mikulandra,¹ Matea Facković,¹ Anamarija Lulić,¹ Iva Habinovec,¹ Noelle Benčić,¹ Mirjana Bukvić Krajačić,² Ivan Grgičević,² Tomislav Jednačak,¹ Marina Cindrić,¹ Predrag Novak¹

¹Department of Chemistry, Faculty of Science, Zagreb, Croatia

²Fidelta d.o.o., Zagreb, Croatia

E-mail: mikulandra.ivana@gmail.com

Macrolide antibiotics, such as azithromycin, have been widely prescribed for the treatment of respiratory tract infections owing to their high efficacy and safety [1]. Azithromycin belongs to an azalide subclass of 15-membered macrolide antibiotics. Emerging multi-drug resistant microbial pathogens present today a serious and challenging global problem which demands novel and more effective antimicrobial agents to be discovered. Thiosemicarbazones and some of their metal complexes have been shown to possess anti-infective, anti-inflammatory and antitumor activities. Some thiosemicarbazones have proven very useful to treat infections, such as the new antibiotics perchlozone and thiacetazone, which are good new agents against tuberculosis [2]. Our earlier experiments which included synthesis and biological and structural characterization of some macrolide conjugates showed that those hybrid compounds exhibited good activity against some resistant bacterial strains [3-4]. Here, we present synthesis and characterization of novel macrolide conjugates, the macrozones by linking azithromycin and some selected thiosemicarbazones.

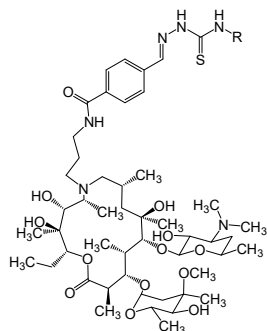

Figure 1: Structure of macrozones, the novel macrolide conjugates.

References

- [1] B. Arsić, P. Novak, M. G. Rimoli, J. Barber, G. Kragol and F. Sodano, *Macrolides: Properties, Synthesis and Applications*, De Gruyter, Berlin, 2018.
- [2] M. Sheikhy, A. R. Jalilian, A. Novinrooz and F. Motamedi-Sedeh, *J. Biomed. Sci. Eng.* **5** (2012) 39-42.
- [3] M. Bukvić Krajačić, P. Novak, M. Dumić, M. Cindrić, H. Čipčić Paljetak and N. Kujundžić, *Eur. J. Med. Chem.* **44** (2009) 3459-3470.
- [4] M. Bukvić Krajačić, M. Dumić, P. Novak, M. Cindrić, S. Koštrun, A. Fajdetic, S. Alihodžić, K. Brajša and N. Kujundžić, *Bioorg. Med. Chem. Lett.* **21** (2011) 853-856.

Computational and experimental study of hydrogen atom reactions with halogenated organic molecules in aqueous solutions

Računalno i eksperimentalno istraživanje reakcija vodikova atoma s halogeniranim organskim molekulama u vodenim otopinama

Ivana Nikšić-Franjić,¹ Igor Sviben,² Marija Bonifačić,² Ivan Ljubić¹

¹Department of Physical Chemistry, Ruđer Bošković Institute, Zagreb, Croatia

²Department of Materials Chemistry, Ruđer Bošković Institute, Zagreb, Croatia

E-mail: iniksicf@irb.hr

Free radical reactions in aqueous media typically exhibit a rich variety of fundamentally important reaction mechanisms in close competition. The reactions of hydrogen atom which take place in non-buffered and buffered (bicarbonate or phosphate) aqueous media are in the focus of our research. We present experimental and theoretical studies of the H atom in reaction with various haloorganic substrates, such as monohaloacetates (chloroacetate, bromoacetate, and iodoacetate) and a modified nucleobase 5-bromouracil. The H atom is experimentally generated as a primary water radical by the steady state γ -radiolysis of water solutions. The reaction mechanisms and rates are computed in the framework of density functional theory in conjunction with the polarizable continuum model (PCM) for an implicit description of the water solvent [1-3]. A possibility that the reduction of the haloorganic substrates by the H atom could follow the proton-coupled electron transfer (PCET) route is of special interest. PCET is a ubiquitous reaction mechanism that is of vast importance to energy conversion in biological and man-made processes as it normally provides the kinetically most favorable means of transfer of the elementary charge (Figure 1). The prospect of PCET occurring in these systems is fascinating because this would imply disintegration of the H atom to the constituting proton and electron thereby representing the most fundamental instance of the process. The pathways that are expected to be in competition with the PCET are hydrogen transfer (HAT), the direct abstraction of the halogen atoms, substitutions and additions. The increase in the dehalogenation yields in the presence of the basic buffer anions, which fulfill the role of external proton acceptors thus promoting the PCET pathway, would be especially indicative of the PCET.

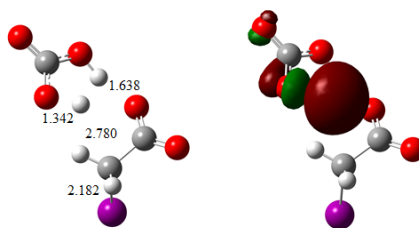

Figure 1: The PCET transition state and its singly occupied molecular orbital (SOMO) in the reaction of H atom with iodoacetate in presence of the HCO_3^- anion (distances in Å).

References

- [1] I. Džeba, M. Bonifačić, I. Nikšić-Franjić and I. Ljubić, *Phys. Chem. Chem. Phys.* **20** (2018) 19829-19840.
- [2] I. Ljubić, A. Sabljčić and M. Bonifačić, *J. Phys. Chem. B* **120** (2016) 11810-11820.
- [3] I. Ljubić, B. Matasović and M. Bonifačić, *Phys. Chem. Chem. Phys.* **41** (2013) 18001-18011.

Nanostructured zinc oxide as electron transport layer in perovskite solar cells Nanostrukturirani cinkov oksid kao sloj za vođenje elektrona u perovskitnim solarnim ćelijama

Ivana Panžić,¹ Vedran Kojić,¹ Jimmy Mangalam,² Thomas Rath,² Vilko Mandić,³ Krunoslav Juraić,¹ Gregor Trimmel,² Andreja Gajović¹

¹Institut Ruđer Bošković, Zagreb, Hrvatska

²Institute for Chemistry and Technology of Materials, Graz, Austrija

³Fakultet kemijskog inženjerstva i tehnologije, Zagreb, Hrvatska

E-mail: ipanzic@irb.hr

In perovskite solar cells (PSC), high photovoltaic performance is governed by the extent of electron mobility, achieved between the photoactive core layer and adjacent transport oxide layers. An effective PSC usually consists of an electron transport material (ETM) (such as mesoporous metal-oxide film) with adsorbed photoactive perovskite and a hole transport oxide deposited on top, all between electric contacts. Among these, TiO₂ films have been widely used as ETM, especially nanostructured. However, the preparation of TiO₂ films requires considerable thermal treatment, which limits the application at flexible substrates. Having similar electron band structure and physical properties to TiO₂, ZnO, which can be easily solution-processed in a variety of nanostructured morphologies, is a viable low-temperature alternative for PSC with high power conversion efficiency (PCE).

In this work, the role of the type and morphology of the ETM layer on the PSC performance was investigated, *i.e.* PSC devices were prepared using two different types of ETM layer configuration: a) zinc oxide ordered nanorod films, and b) titania mesoporous films. Devices were fabricated at indium tin oxide (ITO) glass substrates. The cells were prepared in protective atmosphere and characterized immediately upon fabrication.

J/V measurements show that the photovoltaic performance of the TiO₂ devices surpasses that of ZnO nanorod PSC devices. Even though the nanorod morphology is tailored to increase their specific surface area and therefore the charge transfer, the solar cells fail to increase PCE on behalf of the high charge recombination in 1D ZnO nanostructure. The quantum efficiency (EQE) shows good utilization of the solar spectra, especially at lower wavelengths. Raman measurements show traces of PbI₂ and PbBr₂, but high fluorescence and fast sample degradation hinder the feasibility of Raman characterization. X-ray diffraction (XRD) allows good insight in the presence of crystalline constituent and decomposition products. Scanning electron microscopy (SEM) and energy dispersive spectroscopy (EDS) mapping allowed insight in homogenous incorporation and infiltration of perovskite layer on and into the ZnO nanorods. PSCs based on nanostructured ZnO show high margin for improvement on behalf of surface modifications of the ZnO layer like passivation or doping.

Synthesis and cytostatic activity of novel 1,2,3-triazolyl-tagged coumarin and iminocoumarin derivatives

Sinteza i citostatska aktivnost novih 1,2,3-triazolilnih derivata kumarina i iminokumarina

Ivana Sokol,¹ Nikolina Kalčec,¹ Mia Krnić,¹ Nataša Perin,¹ Sandra Liekens,²
 Silvana Raić-Malić,¹ Tatjana Gazivoda Kraljević¹

¹Faculty of Chemical Engineering and Technology, University of Zagreb

²Rega Institute, Department of Microbiology and Immunology, Leuven, Belgium

E-mail: isokol1@fkit.hr

Coumarin derivatives are important motifs, which can be widely found in many natural products, and many of them displaying diverse biological activities. Many molecules based on the coumarin have been synthesized utilizing innovative synthetic techniques. The diversity oriented synthesis has led to interesting derivatives including the iminocoumarins, furanocoumarins and pyranocoumarins, which have been found to be useful in photochemotherapy, antitumor and anti-HIV therapy, and as stimulants for central nervous system, antibacterials, anti-inflammatory agents, anti-coagulants, and dyes [1]. Benzofused derivatives of coumarin bridged with 1,2,3-triazole emerged as the class of compounds exhibiting the highest antiproliferative activity [2]. Furthermore, 1,2,3-triazole ring has a great role as pharmacophore which is responsible for antitumor and antimicrobial activity. It is introduced in many drugs due to moderate dipole properties, rigid structure and stability in vivo. Besides, 1,2,3-triazoles have attracted considerable attention in recent years because of their wide range of biological activities against various viruses, malignant cells, microorganisms and their inhibitory activities against several enzymes [3]. In order to evaluate cytostatic activity, the novel 1,2,3-triazolyl-tagged coumarin and iminocoumarin derivatives have been synthesized by click reaction of 3-azidocoumarin or 6-azidoiminocoumarines with corresponding terminal acetylenes in the presence of copper as a catalyst. Of the all evaluated compounds against malignant human cell lines, 1,2,3-triazole-coumarin derivative with 3,5-difluoromethylphenyl substituent exhibited the most pronounced activity against HeLa cell lines.

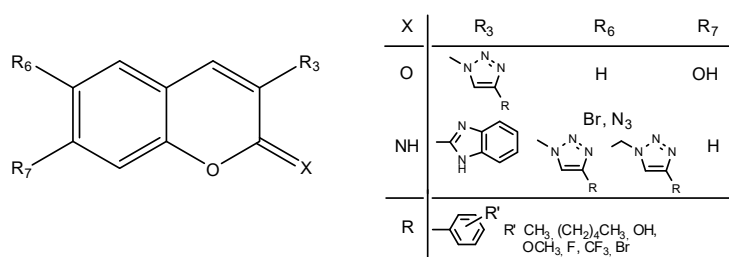

Figure 1: Novel 1,2,3-triazolyl-tagged coumarin and iminocoumarin derivatives.

References

- [1] M. A. Musa, J. S. Cooperwood, M. Omar and O. F. Khan, *Curr. Med. Chem.* **15** (2008) 2664.
 [2] T. Gazivoda Kraljević, A. Harej, M. Sedić, S. Kraljević Pavelić, V. Stepanić, D. Drenjančević, J. Talapko and S. Raić-Malić, *Eur. J. Med. Chem.* **124** (2016) 794.
 [3] S. Raić-Malić and A. Mešić, *Curr. Med. Chem.* **22** (2015) 1462.

Ferrocenylation of uracil and its derivatives

Ferrocenoiliranje uracila i njegovih derivata

Jasmina Lapić,¹ Mateja Toma,² Davor Šakić,² Valerije Vrček,² Senka Djaković¹

¹University of Zagreb, Faculty of Food Technology and Biotechnology, Zagreb, Croatia

²University of Zagreb, Faculty of Pharmacy and Biochemistry, Zagreb, Croatia

E-mail: jlapic@pbf.hr

Modified nucleosides and their components have been in the focus of chemical studies for decades, since the structural modification of nucleosides significantly alters their chemical properties and, therefore, their biological activities. As a result, many modified nucleosides have found therapeutic applications, mainly as antiviral and anticancer drugs [1]. The interest in ferrocenyl derivatives was motivated by the unique properties displayed by ferrocene, in particular its redox features, membrane permeability and low toxicity. The rationale for the introduction of the ferrocenyl group into the nucleoside skeleton is well justified by the expectation for obtaining new classes of genetic information carriers enforced by additional redox-active properties [2]. In search for bioorganometallic systems with an extended conjugation, our research group has prepared ferrocenoyl-nucleobase hybrids in which the two moieties are linked by the carbonyl group [3].

As a continuation of our work concerning ferrocene-labeled pyrimidine derivatives, in these study we report on regioselectivity of ferrocenylation of uracil and its derivatives. To assess the optimized reaction condition, we selected the reaction of uracil with different acylation reagents in the presence of three bases (NaH, K₂CO₃ and Et₃N) as a model reaction (Figure 1). The effect of various solvents (DMF and CH₃CN) and temperatures of deprotection/coupling reactions on the model reaction will be also investigated. The position of substitution in products and the reaction regioselectivity will be explored by spectroscopy methods (1D and 2D-NMR, FTIR) and quantum chemical calculations (DFT level of theory).

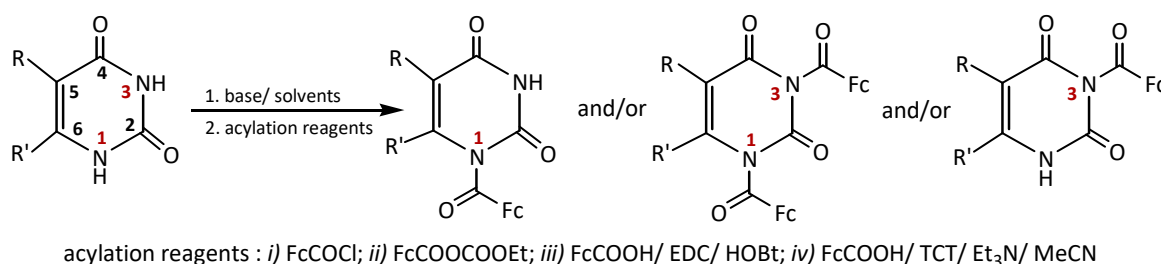

Figure 1: Ferrocenylation of uracil.

References

- [1] S. S. Braga and A. M. S. Silva, *Organomet.* **32** (2013) 5626-5639.
- [2] J. Skiba, Q. Yuan, A. Hildebrandt, H. Lang, D. Trzybiński, K. Woźniak, R. K. Balogh, B. Gyurcsik, V. Vrček and K. Kowalski, *ChemPlusChem.* **83** (2018) 77-86.
- [3] J. Lapić, V. Havaić, D. Šakić, K. Sanković, S. Djaković and V. Vrček, *Eur. J. Org. Chem.* **24** (2015) 5424-5431.

Investigation of nanocrystalline tungsten- and tellurium-based triple perovskites

Istraživanje nanokristalnih trostrukih perovskita na bazi volframa i telurija

Jelena Bijelić,¹ Anamarija Stanković,¹ Elvira Kovač-Andrić,¹ Berislav Marković,¹ Mirjana Bijelić,² Jasminka Popović,³ Željko Skoko,² Goran Štefanić,³ Zvonko Jagličić,^{4,5} Pascal Cop,⁶ Bernd Smarsly,⁶ Georg Garnweitner,⁷ Igor Djerdj¹

¹Josip Juraj Strossmayer University of Osijek, Department of Chemistry, Osijek, Croatia

²University of Zagreb, Faculty of Science, Department of Physics, Zagreb, Croatia

³Ruđer Bošković Institute, Center of Excellence for Advanced Materials and Sensing Devices, Zagreb, Croatia

⁴University of Ljubljana, Faculty of Civil and Geodetic Engineering, Ljubljana, Slovenia

⁵Institute of Mathematics, Physics & Mechanics, Ljubljana, Slovenia

⁶Justus Liebig University Giessen, Physical Chemistry Institute, Giessen, Germany

⁷Technische Universität Braunschweig, Institute for Particle Technology and Laboratory for Emerging Nanometrology, Braunschweig, Germany

E-mail: jbijelic@kemija.unios.hr, igor.djerdj@kemija.unios.hr

Specific structure of perovskite compounds provides them with various interesting properties which vary from magnetic and electric properties to magnetic frustration and half-metallicity. Because of their properties they can be found in numerous technological applications such as transducers, memory devices, solar cells, etc. [1-6]. $A_3B_2(W/Te)O_9$ (A=Sr, Ba; B=Fe, Co) triple perovskites have been prepared in nanocrystalline form using a modified sol-gel route with citric acid as a chelating agent. These materials have been studied by X-ray powder diffraction (PXRD), X-ray photoelectron spectroscopy (XPS), transmission electron microscopy (TEM), thermogravimetric analysis (TGA) and unpolarized Raman spectroscopy, while their magnetic properties have been determined using SQUID measurements. Similar research has already been done with tellurium- [7] and tungsten- [8] based perovskites. In this research the advances of solution chemistry methods (bottom up approach), namely sol-gel citrate route, over the solid state routes towards the synthesis of complex perovskite structures will be presented.

References

- [1] M. E. Lines and A. M. Glass, *Principles and Applications of Ferroelectrics and Related Materials*, Clarendon Press, Oxford, 1977.
- [2] Yu. N. Venevtsev, E. D. Politova and S. A. Ivanov, *Ferroelectrics and Antiferroelectrics with Perovskite type structure*, Chemistry Publ., Moscow, 1985.
- [3] L. G. Tejuca, *Properties and applications of perovskite oxides*, Marcel Dekker, N.Y., 1993.
- [4] M. Fiebig, *J. Phys. D: Appl. Phys.* **38** (2005) 123-152.
- [5] Y. Tokura, *J. Magn. Mater.* **310** (2007) 1145-1150.
- [6] W. Eerenstein, N. D. Mathur and J. F. Scott, *Nature* **442** (2006) 759-765.
- [7] I. Djerdj, J. Popović, S. Mal, T. Weller, M. Nuskol, Z. Jagličić, Ž. Skoko, D. Pajić, C. Suchomski, P. Voepel, R. Marschall, B. Kozlevčar and B. M. Smarsly, *Cryst. Growth Des.* **16** (2016) 2535-2541.
- [8] J. Bijelić, A. Stanković, B. Matasović, B. Marković, M. Bijelić, Ž. Skoko, J. Popović, G. Štefanić, Z. Jagličić, S. Zellmer, T. Preller, G. Garnweitner, T. Đorđević, P. Cop, B. Smarsly and I. Djerdj, *Crys. Eng. Comm.* **21** (2019) 218-227.

Correlations between structural and stability parameters of crude oils and their heavy fractions

Usporedba strukturnih parametara i parametara stabilnosti sirovih nafti i njihovih teških frakcija

Jelena Parlov Vuković,¹ Bruno Pinević,² Ljiljana Marinić Pajc,¹ Lucija Konjević,¹ Nada Uzorinac Nasipak,¹ Tomislav Jednačak,² Predrag Novak²

¹Central testing laboratory, INA Industrija nafte d.d., Zagreb

²Department of Chemistry, Faculty of Science, University of Zagreb, Croatia

E-mail: jelena.parlov-vukovic@ina.hr

The characterization of crude oils and their heavy fractions is an important task in oil industry with regard to quality of final products. A common characteristic of oil samples is a complex chemical composition. Components present in oil samples differ in structure, size, polarity and functionality. One of the main problems during oil recovery and refining process is associated with the presence of the compounds called asphaltenes.

In this work NMR spectroscopy in combination with automated flocculation titration method was used to study three different crude oils and their fractions, vacuum gas oils and residues. Pseudo two-dimensional DOSY NMR technique was applied to separate components from crude oils according to their diffusion coefficients. Furthermore, asphaltenes were isolated from crude oil and their fractions. Asphaltenes are complex organic macromolecular mixtures containing condensed aromatic and saturated rings, aliphatic moieties and different heteroatoms [1,2]. They can cause many problems during production, such as blocking of production pipes, reduction in oil flow and catalyst deactivation. Despite many efforts and a variety of analytical methods used, the complex asphaltene structures are not completely elucidated [3].

References

- [1] J. Parlov Vuković, P. Novak, J. Plavec, M. Friedrich, Lj. Pajc Marinić and T. Hrenar, *Croat. Chem. Acta* **88** (2015) 89-95.
- [2] J. Parlov Vuković, T. Hrenar, P. Novak, J. Plavec and M. Friedrich, *Energy Fuels* **31** (2017) 8095-8101.
- [3] J. Parlov Vuković, P. Novak, T. Jednačak, M. Kveštak, D. Kovačević, V. Smrečki, I. Mikulandra, S. Glanzer and K. Zangger, *J. Dispers. Sci. Technol.* in press.

Synthesis of methyl 5-cycloaminyl-1,2-oxazole-4-carboxylates Priprava metil-5-cikloaminil-1,2-oksazol-4-karboksilata

Jolita Kuginytė,^{1,2} Greta Ragaitė,¹ Miglė Dagilienė,¹ Vaida Milišiūnaitė,¹ Gita Matulevičiūtė,¹
Frank A. Slok,³ Algirdas Šačkus^{1,2}

¹Institute of Synthetic Chemistry, Kaunas University of Technology, Kaunas, Lithuania

²Department of Organic Chemistry, Kaunas University of Technology, Kaunas, Lithuania

³Vipergen ApS, Copenhagen, Denmark

E-mail: jolita.kuginyte@ktu.lt

Cyclic amino acids are widely used as scaffolds for the preparation of various functionalized heterocycles. Conjugation of cyclic amino acids with heteroaromatic carboxylic acids can provide an opportunity for developing novel, conformationally *constrained building blocks for drug discovery and peptidomimetics*. In the present work, various achiral and chiral cyclic α -, β - and γ -amino acids were used in the preparation of novel 1,2-oxazole derivatives possessing adjacent cycloaminyl and methyl carboxylate moieties on the heteroaromatic ring.

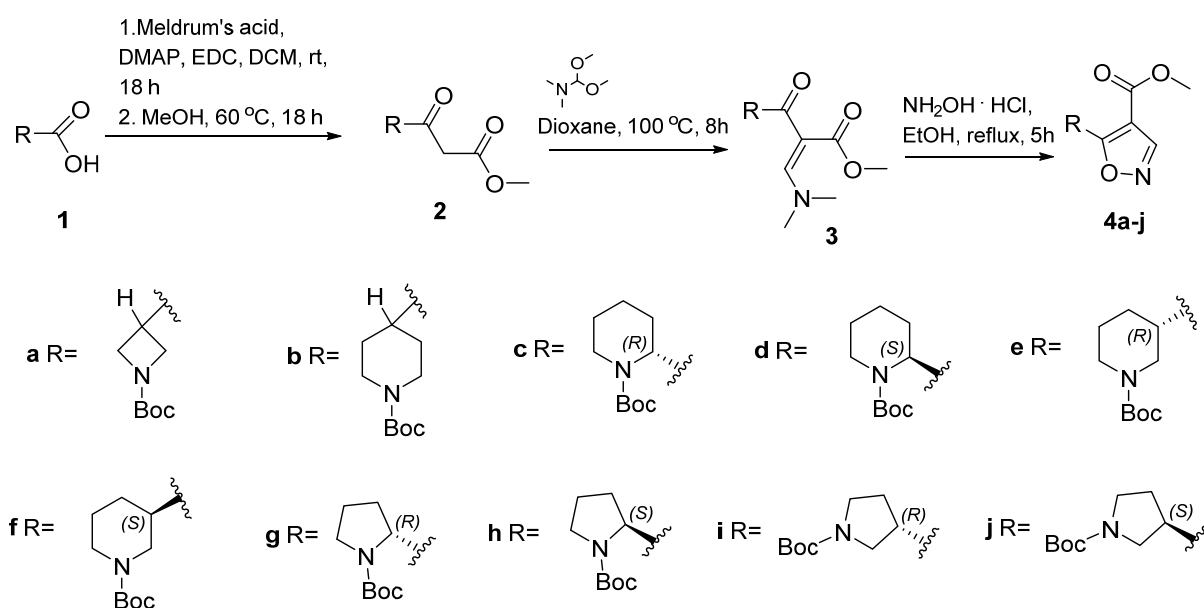

Scheme 1: Synthesis of methyl 5-cycloaminyl-1,2-oxazole-4-carboxylates.

The accomplished synthesis pathway is outlined in Scheme 1. The structures of the novel 1,2-oxazole derivatives were confirmed by ^1H , ^{13}C and ^{15}N NMR spectroscopy and HRMS investigations. The optical purity of the chiral compounds was determined by chiral HPLC analysis.

Potentiometric determination of fluoride in wines of Dalmatia area and statistical analysis

Potenciometrijsko određivanje fluorida u vinima s područja Dalmacije i statistička analiza

Josip Radić,¹ Ivana Munitić,¹ Irena Budić-Leto,² Marija Bralić¹

¹Faculty of Chemistry and Technology, Split, Croatia

²Institute for Adriatic Crops and Karst Reclamation, Split, Croatia

E-mail: jradic@ktf-split.hr

Fluorine is an essential element for human health. Deficiency or excess of fluorine can cause different health problems. The largest source of fluoride is water, but it can also be found in foods (vegetables) and other drinks, such as tea juices, alcoholic beverages and wines [1,2]. Proportion of fluoride ions in drinks varies depending on their technological production process and the origin of beverages [3]. A total of 30 samples of red and white wines from different production areas in Dalmatia were analyzed in this study. Fluorides were determined potentiometrically using commercial fluoride ion-selective electrode by means of the standard addition method. Before the measurement, the calibration curve was prepared with the standard NaF solution in the concentration range from 1×10^{-1} to 1×10^{-6} mol L⁻¹ at the pH value of 4.7. The measurements were made with constant ionic strength (0.1 M KNO₃) at room temperature. In all analyzed wine samples, pH value, alcohol concentration in volume percentage and ash content were determined using standard physicochemical analysis methods. Fluoride mass concentrations in white wines were ranged from 0.12 mg L⁻¹ to 0.27 mg L⁻¹, whereas in red wines they were ranged from 0.07 mg L⁻¹ to 0.40 mg L⁻¹. The analyzed wines are within the recommended limits for the concentration of fluoride in wine (1.0 mg L⁻¹) [4].

Using the statistical analysis method (Spearman correlation, cluster analysis), the correlation between the type of wine and the production area with the mass concentration of fluoride and some other analytical parameters was determined.

References

- [1] B. E. Trombella, A. Caputi, D. Musso, A. Ribeiro and T. Ryan, *J. AOAC Int.* **86** (2003) 1203-1207.
- [2] A. Prkić, J. Giljanović, M. Bralić and K. Boban, *Int. J. Electrochem. Sci.* **7** (2012) 1170-1179.
- [3] M. Goschorska, I. Gutowska, I. Baranowska-Bosiacka, M. E. Rać and D. Chlubek, *Biol. trace elem. res.* **171** (2016) 468-471.
- [4] OIV Issue 2015/01. XXXVII, *International Code of Oenological Practices*.

**Interpolyelectrolyte neutralization in solutions and at
electrically charged surfaces**
**Interpolielektrolitna neutralizacije u otopinama
i na električki nabijenim površinama**

Jasmina Salopek, Davor Kovačević, Tomislav Kremer, Nikola Cindro, Josip Požar
*Division of Physical Chemistry, Department of Chemistry, Faculty of Science, University of Zagreb,
Zagreb, Croatia*

E-mail: pozar@chem.pmf.hr

Complexation between high-charge density linear polycations (polydiallyldimethylammonium, polyallylammonium, and poly(*N*-ethyl-4-vinylpyridinium) cation) and polystyrenesulfonate anion in aqueous solutions of binary sodium salts (NaX; X = F, Cl, Br, NO₃, ClO₄) was studied by means of electrokinetics, dynamic light scattering, microcalorimetry and spectrophotometry. The formation of corresponding multilayers at matching ionic conditions was monitored using quartz crystal microbalance. At lower monomolar ratios, charged polyelectrolyte nano-complexes were formed. Further increase in titrant to titrand ratio led to flocculation taking place near the equivalence. By contrast, the nano-complex charge reversal was achieved by the abrupt instead of stepwise titrant addition. The presence of electrolyte affected the interpolyelectrolyte neutralization in solution considerably, leading to anion-specific aggregation and extrinsic charge compensation (surplus of polycation with respect to polyanion monomers in metastable products formed). The pairing of monomer units was predominantly entropically driven, irrespectively of the type of reaction products formed (polyelectrolyte complexes, precipitates) and electrolyte present. The conversion of metastable to equilibrium products proceeded solely at higher salt concentrations. Analogous electrolyte influence on the multilayer built-up at quartz surface was noticed as in the case of corresponding interpolyelectrolyte reactions in solution. Importantly, the outcomes of surface-based experiments could be predicted by examining the result of solution-based studies and *vice versa*.

References

- [1] J. Požar and D. Kovačević, *Soft Matter* **10** (2014) 6530-6545.
- [2] T. Kremer, D. Kovačević, J. Salopek and J. Požar, *Macromolecules* **49** (2016) 8672-8685.

Acknowledgment: This research was fully supported by the Croatian Science Foundation (project SAQUINT, IP-2014-09-6972).

Lung cancer oncogene mutations reflection in thermally induced blood serum proteins denaturation

Mutacije onkogeno raka pluća i njihov odraz u termalno potaknutoj denaturaciji proteina u krvnom serumu

Karolina Kędra-Królik,¹ Izabela Chmielewska,² Anna Michnik,³ Piotr Zarzycki⁴

¹*Institute of Physical Chemistry, PAS, Warsaw, Poland*

²*Department of Pneumology, Oncology and Allergology Medical University of Lublin, Lublin, Poland*

³*Department of Medical Physics, A. Chełkowski Institute of Physics, Silesian Center for Education and Interdisciplinary Research, University of Silesia, Chorzów, Poland*

⁴*Energy Geoscience Division, Lawrence Berkeley National Laboratory, Berkeley, USA*

E-mail: kkedrakrolik@ichf.edu.pl

Lung cancer is the leading cause of death from cancer worldwide [1]. This genetic disease results from an accumulation of many DNA alterations. The DNA-mutations manifest themselves at the cellular level in modified structure of expressed proteins. This may be reflected in alteration of the blood serum composition [2,3].

Our pilot study on chemotherapy efficacy in lung cancer patients shows that changes in heat capacity of blood serum proteins are sensitive to the genomic alteration [4]. Here, we report differential scanning calorimetry (DSC) analysis of 15 blood serum samples from the patients with non-small cellular lung cancer (NSCLC), adenocarcinoma, and compared them with those from the healthy ones. We focused on two genetic alterations: activating mutations of the epidermal growth factor receptor (EGFR) and anaplastic lymphoma kinase (ALK) rearrangements in NSCLC, which are targetable to the implementation of precision therapy. The analysis of blood serum proteins DSC profiles allows us to identify the individuals with EGFR or ALK mutations. Moreover, the thermograms indicate differences in proteins aggregation in thermally affected serum samples.

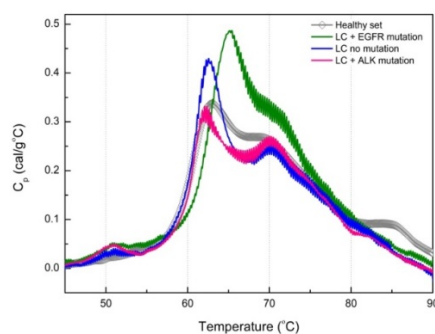

Figure 1: DSC profiles of serum samples from NSCLC patients without mutation (blue), with EGFR (green) and ALK (red) rearrangement set with healthy volunteers (grey).

References

- [1] L. A. Torre, F. Bray, R. L. Siegel, J. Ferlay and J. Lortet-Tieulent, *CA Cancer J. Clin.* **65** (2015) 87.
- [2] J. L. Mulshine, *Nat. Rev. Cancer* **3** (2003) 65.
- [3] S. Pelengaris and M. Khan, in: *The Molecular Biology of Cancer*, S. Pelengaris, M. Khan (Eds.) Wiley-Blackwell, 2013.
- [4] K. Kędra-Królik, I. Chmielewska, A. Michnik and P. Zarzycki, *Sci. Rep.* **7** (2017) 16796.

Acknowledgment: This work was supported by the NCN Grant Sonata Bis (UMO-2016/22/E/ST4/00446).

Complexation properties of phenantridine-based calix[4]arene derivatives Kompleksacijska svojstva fenantridinskih derivata kaliks[4]arena

Katarina Leko, Andrea Usenik, Nikola Cindro, Matija Modrušan, Vladislav Tomišić
Division of Physical Chemistry, Department of Chemistry, Faculty of Science, University of Zagreb,
Zagreb, Croatia

E-mail: kleko@chem.pmf.hr

Calixarenes are macrocyclic oligomers consisted of four or more phenolic residues linked by methylene bridges in the *ortho* position. As such, they can be easily functionalized with ketone, ester, amide, or other functional groups on the lower and/or upper rim to give efficient receptors for various ionic or neutral species. Due to the prominent sensitivity of fluorescence spectroscopy and high affinity of these macrocyclic ligands towards cations, it is possible to prepare highly sensitive ion sensors by introducing fluorescent substituents into the calixarene moiety [1-4].

In the scope of this work, the binding affinities of tertiary amide and ester phenantridine-based calix[4]arene derivatives **L1** and **L2** towards alkali, alkaline earth and lanthanide cations in various organic solvents (acetonitrile, methanol, ethanol, *N,N*-dimethylformamide, dimethyl sulfoxide) were investigated. Stability constants of the corresponding complexes were determined (or in some cases only assessed) by means of UV spectrophotometry, fluorimetry, and isothermal titration calorimetry. The latter technique also provided information on reaction enthalpies and entropies. The obtained thermodynamic parameters were discussed regarding the structural characteristics of the studied compounds and solvation properties of the solvents used.

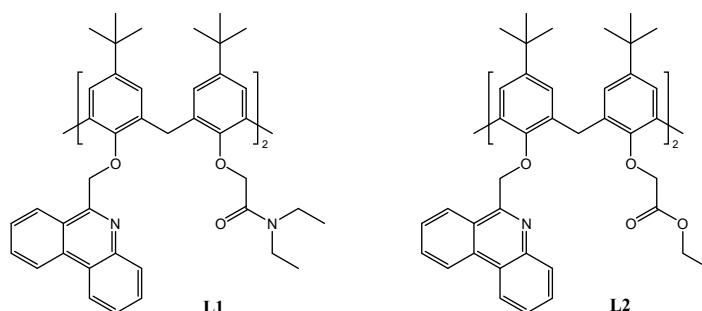

Figure 1: Structures of calix[4]arene derivatives **L1** and **L2**.

References

- [1] J. S. Kim and D. T. Quang, *Chem. Rev.* **107** (2007) 3780-3799.
- [2] M. Tranfić Bakić, D. Jadreško, T. Hrenar, G. Horvat, J. Požar, N. Galić, V. Sokol, R. Tomaš, S. Alihodžić, M. Žinić and L. Frkanec, *RSC Adv.* **5** (2015) 23900-23914.
- [3] N. Galić, N. Burić, R. Tomaš, L. Frkanec and V. Tomišić, *Supramol. Chem.* **23** (2011) 389-397.
- [4] N. Bregović, N. Cindro, L. Frkanec and V. Tomišić, *Supramol. Chem.* **28** (2016) 608-615.

Acknowledgment: This research was fully supported by the Croatian Science Foundation (project SupraCAR, IP-2014-09-7309).

Photophysical properties and photochemical reactivity of a quinone methide precursor containing BODIPY chromophore

Fotofizička svojstva i fotokemijska reaktivnost prekursora kinon metida koji sadrže BODIPY kromofor

Katarina Zlatić, Ivana Antol, Nikola Basarić

Department of Organic Chemistry and Biochemistry, Ruđer Bošković Institute, Zagreb, Hrvatska

E-mail: Katarina.Zlatic@irb.hr

BODIPY® is a tradename for a class of compounds containing a 4,4-difluoro-4-bora-3a,4a-diaza-s-indacene group. BODIPY derivatives are commonly used as dyes for biomolecular labeling since they are characterized by good photochemical stability and excellent photophysical and spectral properties [1]. On the other hand, quinone methides (QM) are reactive intermediates that can be generated in photochemical reactions, [2] that exhibit biological activity, which is related to their ability to alkylate DNA [3]. The objective of our research is to combine these two groups in one molecule and to develop potential photoactivable anticancer drugs [4].

Herein we present a study of photochemical reactivity for BODIPY quinone methide precursor molecule **1**. Its photophysical properties were investigated by steady-state and time resolved fluorescence. The photochemical reactivity was investigated by irradiations in CH₃OH solution at different wavelengths. Interestingly, the photochemical reactivity is dependent on the wavelength used for irradiation, contrary to the Kasha photochemical law. The experimental observations were backed up by TD-DFT calculations.

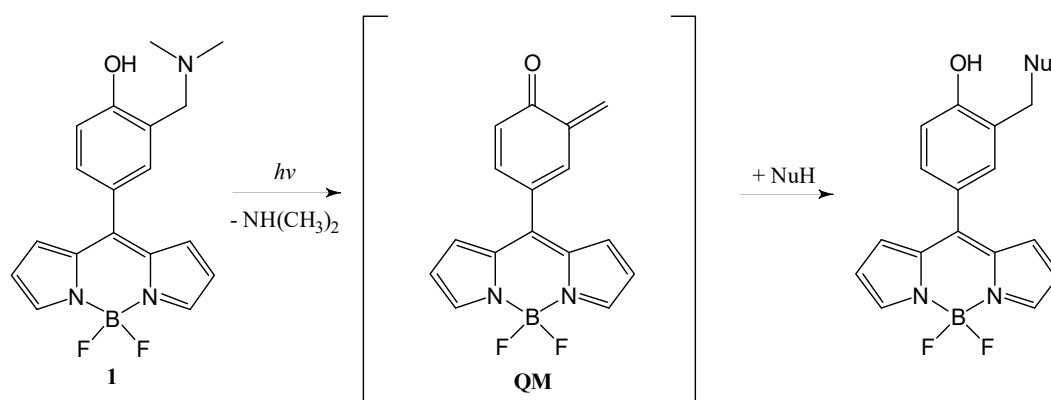

Figure 1: Photoreaction of synthesized molecule **1**.

References

- [1] A. Loudet and K. Burgess, *Chem. Rev.* **107** (2007) 4891-4932.
- [2] N. Basarić, K. Mlinarić-Majerski and M. Kralj, *Curr. Org. Chem.* **18** (2014) 3-18.
- [3] S. E. Rokita, *Quinone methides*, John Wiley & Sons, Hoboken, 2009.
- [4] N. Basarić, M. Kralj, A. M. Mikecin and M. Cindrić, EP16169771.9, 16. 05. 2016.; PCT/HR2017/000005, 18446744073709551615, HR 15.05.2016.

Development and validation of stability indicative UHPLC method for determination of crizotinib and its degradation products

Razvoj i validacija stabilitetno indikativne UHPLC metode za određivanje krizotiniba i njegovih razgradnih produkata

Kristina Tolić,¹ Dragana Mutavdžić Pavlović,¹ Mislav Runje²

¹Fakultet kemijskog inženjerstva i tehnologije, Zagreb, Hrvatska

²Pliva Croatia TAPI R&D, Zagreb, Hrvatska

E-mail: ktolic@fkit.hr

In addition to the pharmaceutically active substance, it is also essential to know about the impurities present in the drug, resulting from its production or degradation. According to the ICH guidelines, impurities are classified as organic impurities, inorganic impurities and residual solvents. Organic impurities include products originated by degradation of active pharmaceutical ingredient (API) under the influence of temperature, light, pH change, etc. [1]. Various studies have shown that new formed degradation impurities may have different toxic effects and impacts on safety and efficacy of the applied drug. For this purpose, forced degradation studies, also defined according to the ICH guidelines, are conducted exposing the new drug to various stress conditions (hydrolysis: acid and basic, oxidation, photolysis, humidity, temperature...) in order to develop a stable-indicative method and define the degradation pathways for a new active substance.

According to a literature review, only a few methods for the analysis of crizotinib in pharmaceutical dosage have been developed. Crizotinib is a pharmaceutical used in the treatment of lung cancer as a tyrosine kinase receptor inhibitor. Therefore, the aim of this research was to develop and validate the new RP-UHPLC-DAD selective method for the determination of crizotinib in the presence of the resulting degradation products. Its stability was tested by forced degradation studies in acidic, basic and oxidizing conditions. The major degradation products were subsequently identified and characterized by liquid chromatography coupled to a mass spectrometer as a detector.

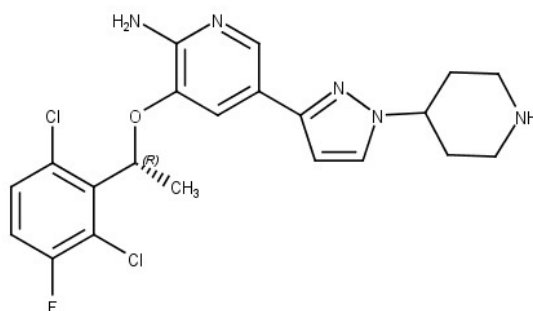

Figure 1: Chemical structure of crizotinib.

References

[1] ICH Harmonised tripartite guideline, *Impurities in new drug substances Q3A (R2)* (2006).

**Application of thermal analysis as screening tool for monitoring of
amorphous phase content and compatibility study
Primjena metoda termičke analize pri praćenju udjela
amorfne faze i kompatibilnosti**

Lara Štajner, Lorena Kordić, Sanja Matečić Mušanić
Pliva, Zagreb, Croatia

E-mail: Lara.Stajner@pliva.com

The methods of thermal analysis, such as differential scanning calorimetry (DSC) and thermogravimetric analysis (TGA), are often used for physical characterization of active pharmaceutical ingredients (API). One of nonstandard methods of thermal characterization and investigation of API is microcalorimetry. In this work, two application examples of thermal analysis in pharmaceutical industry will be shown. The first of them is monitoring and quantification of the amorphous content in final micronized API material, and second application will be related to the study of compatibility between API and excipients by nonstandard microcalorimetry technique.

During the micronization process, some small amounts of the amorphous phase can be formed, what can have negative influence on powder properties of the final product (such as agglomeration, flowability...). Because of this it is very important to develop the method that is sufficiently sensitive (low quantification limit) for monitoring of low amorphous content in the micronized samples. The XRD technique is often not sufficiently sensitive for quantification of small amorphous content, so for this purpose the methods of thermal analysis such as DSC or microcalorimetry are more suitable. In this research the development of DSC method for quantitation of amorphous content is shown that is based on quantification of heat of crystallization determined from non-reversible heat flow signal. Microcalorimetry, frequently used for the study of polymorphic transformation and quantification of amorphous or some other crystal forms in API, can also be used as nonstandard technique for the compatibility study of API and excipients (such as mannitol, lactose monohydrate, cellulose, starch) used in formulation. As opposed to conventional methods for compatibility determination (XRD, DSC, TGA, FTIR, HPLC), which can take many weeks or months, the microcalorimetry experiment typically takes only a few hours what is a great advantage of this approach.

Obtained results shows that the developed DSC method is highly sensitive for determination of low amorphous amount (quantification limit: 0.5%), and also that microcalorimetry is a powerful tool for the compatibility study.

**1,2-bis[(1-methyl-1*H*-imidazol-2-yl)thio]ethane:
 synthesis, characterisation and solid state transformation
 1,2-bis[(1-metil-1*H*-imidazol-2-il)tio]etan:
 sinteza, karakterizacija i transformacija u čvrstom stanju**

Leo Štefan,¹ Dubravka Matković-Čalogović,² Miljenko Dumić³

¹JGL d.d. Jadran Galenski Laboratorij, Rijeka, Hrvatska

²Sveučilište u Zagrebu, Prirodoslovno-matematički fakultet, Kemijski odsjek, Zagreb, Hrvatska

³Odjel za biotehnologiju Sveučilišta u Rijeci, Rijeka, Hrvatska

E-pošta: leo.stefan@jgl.hr

U okviru studija stabilnosti tireostatika metimazola (1-metil-2,3-dihidro-1*H*-imidazola, **1**) [1] proučena je njegova degradacija u otopini 1,2-dikloretana pri sobnoj temperaturi. Nađeno je da i bez prisutnosti svjetla nakon 15 dana dolazi do nastajanja 1,2-bis[(1-metil-1*H*-imidazol-2-il)tio]etan dihidroklorida, koji je u formi tetrahidrata (**2**) izoliran s iskorištenjem od 30,9 %. Produkt je karakteriziran spektroskopskim i termičkim metodama, a struktura je potvrđena rendgenskom strukturnom analizom na jediničnom kristalu.

Tetrahidrat **2**, [C₁₀H₁₆N₄S₂]Cl₂·4(H₂O), kristalizira u prostornoj skupini *P*2₁/*c* monoklinskog kristalnog sustava, sljedećih parametara jedinične ćelije i podataka o utočnjavanju strukture: *a* = 11,1667(10), *b* = 7,7629(7), *c* = 11,8970(13) Å, β = 109,637(11)°, *V* = 971,32(18) Å³, *Z* = 2, *R* = 0,049, *R*_w = 0,1272, *S* = 0,900, 1453 refleksa s *I* > 2σ(*I*).

Neutralizacijom **2**, ekstrakcijom te potom kristalizacijom uparnog ostatka iz smjese aceton/voda dobiven je dihidrat baze naslovne molekule **3**, C₁₀H₁₄N₄S₂·2(H₂O), koji kristalizira u prostornoj skupini *R*-3 trigonskog kristalnog sustava, sljedećih parametara jedinične ćelije i podataka o utočnjavanju strukture: *a* = *b* = 19,3142(13), *c* = 10,3283(5) Å, γ = 120°, *V* = 3336,75 (5) Å³, *Z* = 9, *R* = 0,0398, *R*_w = 0,0994, *S* = 1,047, 1072 refleksa s *I* > 2σ(*I*). Sušenjem u vakuumu dihidrat **3** gubi kristalizacijsku vodu i prelazi u bijelu kristalnu bezvodnu formu **4**.

Detalji sinteze, karakterizacije i transformacije produkata u čvrstom stanju biti će prikazani na posteru.

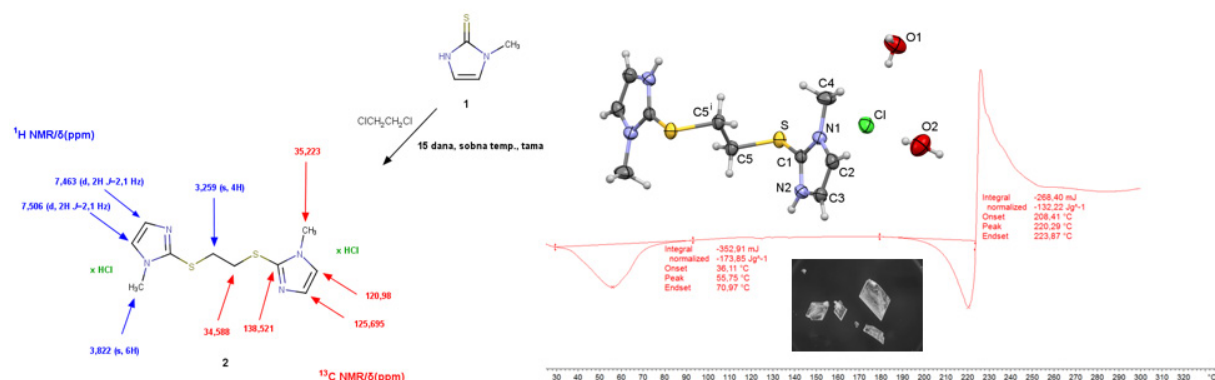

Slika 1: Sinteza i karakterizacija spoja **2**.

Reference

[1] A. B. Emiliano, L. Governale, M. Parks and D. S. Cooper, *Clin. Endocrinol. Metab.* **95** (2010) 2227-2233.

Glutamic acid-derived hydrazine reagent for derivatization of carbonyl compounds

Hidrazino-derivat glutaminske kiseline za derivatizaciju karbonilnih spojeva

Lidija Brkljačić, Ivanka Jerić

Laboratorij za biomimetičku kemiju, Zavod za organsku kemiju i biokemiju, Institut Ruđer Bošković, Zagreb, Hrvatska

E-pošta: lidija.brkljacic@irb.hr

Karbonilni spojevi male molekulske mase u okolišu su najčešće prisutni kao produkti oksidacijskog raspada organskih molekula, dok su u biološkim uzorcima markeri oksidativnog stresa i metaboličkih bolesti. U tako složenim sustavima najčešće se identificiraju i kvantificiraju LC-MS/MS metodama, no kako loše ioniziraju nužna je njihova derivatizacija. 2,4-dinitrofenilhidrazin (DNPH) je najčešće korišten reagens za derivatizaciju karbonilnih spojeva pri čemu nastaju karbonil-2,4-DNP-hidrazoni, no njihovom fragmentacijom u MS/MS analizama ne nastaju specifični fragmenti koji bi bili prikladni za razvoj dovoljno selektivne i osjetljive LC-MS/MS metode [1].

U literaturi je poznato da aminokiselinški ili peptidni derivati, kao bazični spojevi, dobro ioniziraju u MS eksperimentima s pozitivnom ionizacijom te daju bogate i specifične fragmentacijske spektre u MS/MS eksperimentima [2]. Stoga je za rješavanje navedenog problema osmišljen i sintetiziran hidrazino-derivat glutaminske kiseline Z-Glu(NHNH₂)-OEt kao pogodan derivatizacijski reagens. Reakcijom hidrazino-derivata glutaminske kiseline s odabranim karbonilnim spojevima nastaju karbonil-Z-Glu-OEt-hidrazoni koji su po potrebi reducirani u karbonil-Z-Glu-OEt-hidrazide. Nastali produkti su izolirani, okarakterizirani spektroskopskim i spektrometrijskim metodama te upotrijebljeni kao standardi.

Nakon provedene sinteze detaljno su istražena ponašanja nastalih hidrazonskih i hidrazidnih derivata u MS i MS/MS eksperimentima [3]. Osim što dobro ioniziraju, obje vrste derivata u kolizijski induciranoj disocijaciji pokazuju brojne i vrlo specifične ionske produkte koji mogu biti upotrijebljeni za razvoj LC-MS/MS metode kojom će biti moguće pratiti karbonilne spojeve u nižim koncentracijama i u složenim matricama.

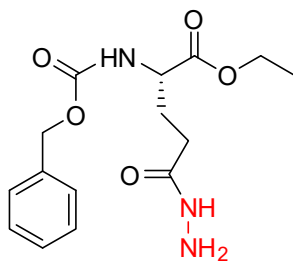

Slika 1: Strukturna formula predloženog derivatizacijskog reagensa Z-Glu(NHNH₂)-Oet.

Reference

- [1] T. Santa, *Biomed. Chromatogr.* **25** (2011) 1-10.
- [2] V. H. Wysocki, K. A. Resing, Q. Zhang i G. Cheng, *Methods* **35** (2005) 211-222.
- [3] L. Brkljačić i I. Jerić, *J. Mass Spectrom.* **53** (2018) 649-654.

The course and the products of the isocyanide-based multicomponent reactions with unprotected carbohydrates

Tijek i produkti višekomponentnih reakcija temeljenih na izocijanidima s nezaštićenim ugljikohidratima

Lidija Varga-Defterdarović, Marijana Vinković, Ivanka Jerić
Institut Ruđer Bošković, Zagreb, Hrvatska

E-pošta: Lidija.Varga-Defterdarovic@irb.hr

Višekomponentne reakcije (MCRs) su reakcije u kojima reagiraju najmanje tri sastojka različitih funkcijskih skupina, a nastaje produkt koji sadržava strukturne dijelove svih sastojaka. Iako su najviše izučavane višekomponentne reakcije temeljene na izocijanidima i to trokomponentne (aldehid, kiselina, izocijanid) (Slika 1. Passerinijeva reakcija) i četverekomponentne (aldehid, amin, kiselina, izocijanid) (Slika 1. Ugijeva reakcija), nezaštićeni ugljikohidrati upotrijebljeni su samo u reakcijama s aminokiselinama (dvofunkcijski spoj). Do sada nije ispitana reaktivnost potpuno nezaštićenih ugljikohidrata (α -glukoze i 2-amino-2-deoksi- α -glukoze) kao aldehidnih (otvorena forma ugljikohidrata), odnosno aldehidno-aminskih sastojaka. Prisustvo nezaštićenih ugljikohidrata i amina u četverekomponentnoj reakciji otvara mogućnost tijeka još jedne u prirodi poznate reakcije koja se odvija u živim organizmima, ali i tijekom termičke obrade i skladištenja hrane, neenzimske Amadorijeve pregradnje (Slika 1). Uz to zanimljivo je da se u prirodi izocijanidni spojevi pojavljuju kao metaboliti prirodnih antibiotika, bakterija, gljivica i plijesni iz flore i faune mora i tala. Sve navedeno otvara mogućnost paralelnog odvijanja spomenutih reakcija i u prirodi. S ciljem ispitivanja ove pretpostavke provedene su modelne četverekomponentne reakcije temeljene na izocijanidima u različitim reakcijskim uvjetima, u kojima su kao aldehidni i amini sastojci upotrijebljeni nezaštićeni ugljikohidrati. Reaktivnost i tijek reakcija svakog od njih ispitana je i s nešećernim aldehidnim, odnosno aminskim sastojcima.

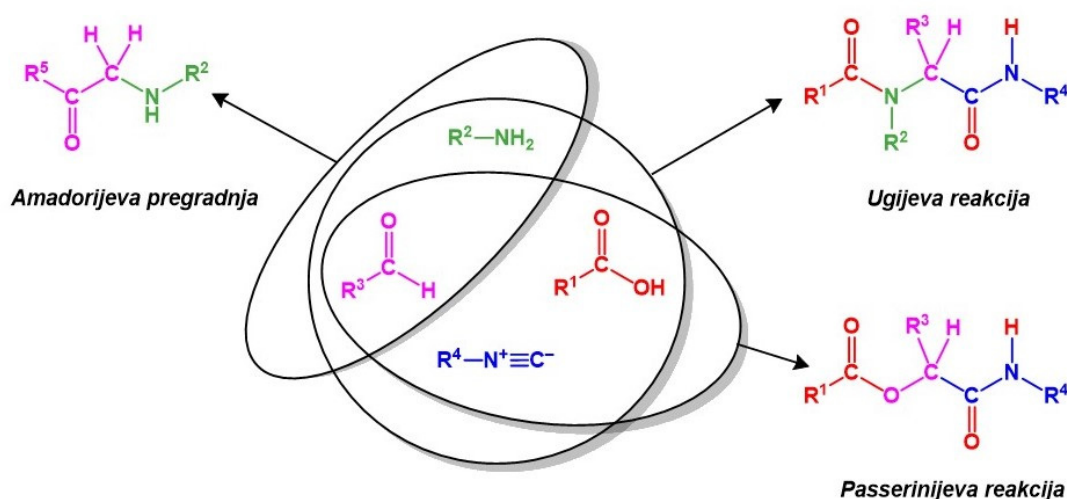

Slika 1: Tijek i produkti višekomponentnih reakcija temeljenih na izocijanidima s nezaštićenim ugljikohidratima kao aldehidnim i aminskim sastojcima.

Synthesis and antimicrobial potential of bisquaternary ammonium compounds based on quinuclidine-3-ol

Sinteza i antimikrobna aktivnost dvostrukih kvaternih amonijevih soli čija je okosnica 3-kinuklidinol

Linda Bazina,¹ Ana Maravić,¹ Ines Primožič,² Matilda Šprung,¹ Renata Odžak¹

¹Faculty of Science, University of Split, Split, Croatia

²Faculty of Science, University of Zagreb, Zagreb

E-mail: linbaz@pmfst.hr

Quaternary ammonium compounds (QACs), as cationic amphiphiles, show broad-spectrum antibacterial activity due to a mechanism based on membrane disruption [1]. Since previously synthesized monoQACs containing quinuclidine-3-ol showed promising antimicrobial potential [2], we have further developed a new series of bisQACs containing quinuclidine-3-ol. In this series, we bind two quinuclidine centers by long alkyl chains of variable length (C8, C10 and C12), assuming that two-headed (bicephalic) QACs would possess even better ability of bacterial membrane disruption (Figure 1). These compounds were screened for antimicrobial activity against Gram-positive and Gram-negative bacterial strains, both ATCC and clinical isolates, as well as fungi and molds. Activity toward inhibition of the biofilm structures was also tested.

Our results show a positive correlation between antimicrobial activity and an alkyl chain length. All tested compounds exhibited moderate antibacterial activity, especially, QOH-C12 with considerably low minimal inhibitory concentration against *S. pyogenes* (MIC = 31.25 µg mL⁻¹). In addition, all compounds exerted very good antifungal activity (MIC₅₀ = 15.6 – 1000 µg mL⁻¹) against food spoilage and pathogenic fungi, including *A. niger*, *P. citrinum* and *C. albicans*. The cytotoxicity measurements toward different human cell lines are currently in progress.

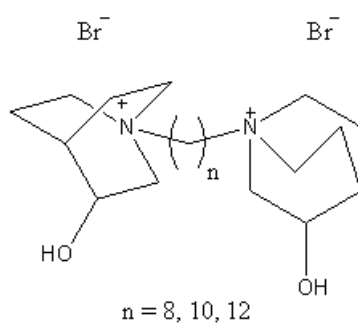

Figure 1: Structural formula of bis-quinuclidine derivatives.

References

- [1] M. C. Jennings, K. P. C. Minbiole and W. M. Wuest, *ACS Infect. Dis.* **1** (2015) 288-303.
[2] L. Bazina, A. Maravić, L. Krce, B. Soldo, R. Odžak, V. Bučević Popović, I. Aviani, I. Primožič and M. Šprung, *Eur. J. Med. Chem.* **163** (2019) 626-635.

Determination of haloacetic acid in drinking water in Croatia Određivanje halooctenih kiselina u vodi za piće u Hrvatskoj

Livia Kurajica, Magdalena Ujević Bošnjak, Jurica Štiglić
Croatian Institute of Public Health, Zagreb, Croatia

E-mail: livia.kurajica@hzjz.hr

The most commonly used disinfectants for the treatment of drinking waters are chlorine and its compounds, and the reasons for that are: lower costs, protection against microbial recontamination and minimum level of chlorine residual throughout the distribution system due to high oxidizing potential [1]. Because of its activity, chlorine can also react with natural organic matter (NOM) present in water and form disinfection byproducts (DBP) [2]. In 1974 Rook [3] identified and reported chloroform and other trihalomethanes in chlorinated drinking water as the first DBPs. Since then studies described approximately 600 – 700 DBPs which are formed by the common disinfectants. Trihalomethanes (THMs) and haloacetic acids (HAAs) make up more than 80% of the total number [4]. According to epidemiological studies, long-time exposure to high levels of DBPs has been associated with an increased risk of bladder cancer among men. Several studies are associating kidney, liver, pancreas, breast, brain cancer and pregnancy outcomes such as fetal growth with exposure to DBPs [5]. US Environmental Agency has established maximum cotaminant level for total trihalomethanes (TTHM) at 80 µg/L and for sum of five HAAs at 60 µg L⁻¹ [6]. However, there is no limit for HAAs in Croatia, only for TTHM which is 100 µg L⁻¹ [7].

The aim of this work was to measure HAA levels in tap waters in different parts of Croatia. Ammonium chloride was added to the Winkler glass bottles prior to sampling to convert free chlorine residual in the sample matrix into combined chlorine. Tap was opened and the system was allowed to flush the bottles and samples were collected from the flowing system. Modified US EPA Method 552.3 was used for the determination of the HAAs. The method uses gas chromatography system coupled with an electron capture detector and a capillary column. In addition, total organic carbon (TOC) was determined in order to study its correlation with HAA.

References

- [1] R. Sadiq and M. J. Rodriguez, *Sci. Total Environ.* **321** (2004) 21-46.
- [2] M. G. Muellner, E. D. Wagner, K. McCalla, S. D. Richardson, Y. T. Woo and M. J. Plewa, *Environ. Sci. Technol.* **41** (2007) 645-651.
- [3] J. J. Rook, *Water Treat. Exam.* **23** (1974) 234-243.
- [4] B. Firdissa, *J. Health Med. Nurs.* **28** (2016) 1-12.
- [5] C. M. Villanueva, S. Cordier, L. Font-Ribera, L. A. Salas and P. Levallois, *Curr. Env. Health Rep.* **1** (2015) 107-115.
- [6] US Environmental Protection Agency, *Federal Register* **63** (1998) 69396.
- [7] Pravilnik o parametrima sukladnosti, metodama analize, monitoringu i planovima sigurnosti vode za ljudsku potrošnju te načinu vođenja registra pravnih osoba koje obavljaju djelatnost javne vodoopskrbe, Narodne novine 125/2017.

Acknowledgment: This work was supported by the Croatian Science Foundation under the project UIP-2017-05-3088.

Synthesis and anti-proliferative activity of novel amidino-substituted aryl-bisbenzothiazoles

Sinteza i antiproliferativna aktivnost novih amidino-supstituiranih arilnih bisbenzotiazola

Lucija Ptiček,¹ Marija Mudrešić,¹ Petra Grbčić,² Sandra Kraljević Pavelić,² Livio Racané¹

¹Department of Applied Chemistry, Faculty of Textile Technology
University of Zagreb, Zagreb, Croatia

²Department of Biotechnology, Centre for High-throughput Technologies
University of Rijeka, Rijeka, Croatia

E-mail: lucija.pticek@ttf.hr

2-arylbenzothiazole derivatives are of considerable interest due to their diverse pharmaceutical properties and have emerged as a privileged scaffold in drug discovery bearing remarkable activity profiles in non-invasive diagnosis of Alzheimer's disease and antitumour effects [1]. Strong anti-proliferative effects on some tumour cell lines were previously shown for isomeric imidazolyl-substituted phenylene-bisbenzothiazole, [2] and imidazolyl-substituted phenyl- and naphthyl-benzothiazoles [3]. These findings have led us to further investigate this class of compounds by introducing different types of amidinic substituents with the aim of improving activity and selectivity on different human tumour cell lines. Additionally, we explored reaction conditions for sustainable approach to synthesis of amidino-substituted phenylene-bisbenzothiazoles by condensation reaction from the corresponding bis(2-aminophenyl) disulfide and aldehyde using glycerol as a green solvent. We found new efficient and sustainable synthetic method for preparation of isomeric amidino-substituted derivatives of bisbenzothiazolyl-phenylenes and naphthalenes (Figure 1). Generally, the *in vitro* anti-proliferative screening of novel diamidino-bisbenzothiazolyl derivatives revealed strong activity on tested tumour cell lines (SW620, HepG2, CFPAC-1 and HeLa) depending on the type of amidinic substituent as well as positions of benzothiazolyl moieties.

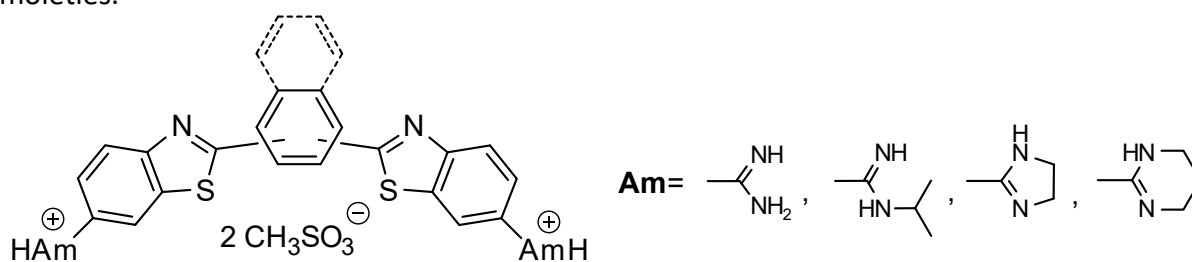

Figure 1: Structure of amidino-substituted aryl-bisbenzothiazoles.

References

- [1] A. A. Weekes and A. D. Westwell, *Curr. Med. Chem.* **16** (2009) 2430-2440.
- [2] L. Racané, S. Kraljević Pavelić, R. Nhili, S. Depauw, C. Paul-Constant, I. Ratkaj, M.-H. David-Cordonnier, K. Pavelić, V. Tralić-Kulenović and G. Karminski-Zamola, *Eur. J. Med. Chem.* **63** (2013) 882-891.
- [3] L. Racané, L. Ptiček, M. Sedić, P. Grbčić, S. Kraljević Pavelić, B. Bertoša, I. Sović and G. Karminski-Zamola, *Mol. Divers.* **22** (2018) 723-741.

Acknowledgment: This work was funded by the Croatian Science Foundation (HRZZ-4379, AntioxPot).

Antitumor activity of novel benzimidazole amidine derivatives of 7-chloro-4-aminoquinoline

Protutumorska aktivnost novih benzimidazolnih amidinskih derivata 7-klor-4-aminokinolina

Luka Krstulović,¹ Marijana Jukić,² Teuta Opačak-Bernardi,² Kristina Starčević,³ Miroslav Bajić,¹ Ljubica Glavaš-Obrovac²

¹Department of Chemistry and Biochemistry, Faculty of Veterinary Medicine, University of Zagreb, Zagreb, Croatia

²Department of Medicinal Chemistry, Biochemistry and Laboratory Medicine, Faculty of Medicine, J. J. Strossmayer University of Osijek, Osijek, Croatia

³Department of Forensic and Judicial Veterinary Medicine, Faculty of Veterinary Medicine, University of Zagreb, Zagreb, Croatia

E-mail: lkrstulovic@vef.hr

As a part of our ongoing effort to prepare novel biologically active compounds, we have synthesized a short series of hybrid molecules in which 7-chloro-4-aminoquinoline is linked to benzimidazole amidine moiety *via m*-phenyl linker [1]. Several 7-chloro-4-aminoquinoline based antimalarial therapeutics are tested for their anticancer activity, two of them (chloroquine and hydroxychloroquine) are currently investigated in clinical trials for cancer therapy [2]. Benzimidazole moiety is found in many known pharmaceuticals displaying, besides anticancer, a variety of biological effects [3]. Positively charged amidine groups are known for their cellular and nuclear uptake.

Novel compounds were evaluated for their *in vitro* cytotoxic activity against normal epithelial (MDCK1) and carcinoma (HeLa, CaCo2, SW-620, MCF-7 and MDAMB231) cell lines using MTT assay.

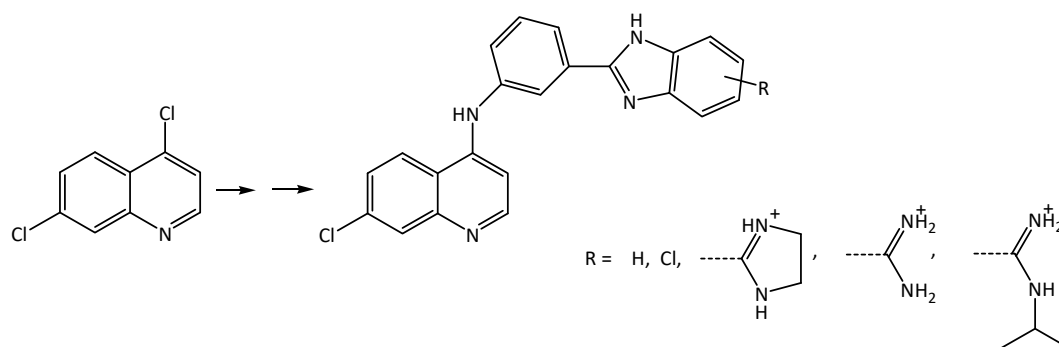

Figure 1: Novel benzimidazole amidine derivatives of 7-chloro-4-aminoquinoline.

References

- [1] L. Krstulović, I. Stolić, M. Jukić, T. Opačak-Bernardi, K. Starčević, M. Bajić and Lj. Glavaš-Obrovac, *Eur. J. Med. Chem.* **137** (2017) 196-210.
- [2] V. W. Rebecca and R. K. Amaravadi, *Oncogene*. **35** (2016) 1-11.
- [3] W. Akhtar, M. F. Khan, G. Verma, M. Shaquiquzzaman, M. A. Rizvi, S. H. Mehdi, M. Akhter and M. M. Alam, *Eur. J. Med. Chem.* **126** (2017) 705-753.

Kinetic spectrophotometric determination of *N*-acetyl-L-cysteine based on the reduction of copper(II)-bathocuproine disulphonate complex
Kinetičko spektrofotometrijsko određivanje *N*-acetil-L-cisteina temeljeno na redukciji kompleksa bakra(II) i batokuproin disulfonata

Maja Biočić, Lea Kukoč Modun, Martina Stipišić, Njegomir Radić
Kemijsko-tehnološki fakultet, Sveučilište u Splitu, Split, Hrvatska

E-mail: mbiocic@ktf-split.hr

N-acetyl-L-cysteine (acetylcysteine, NAC) is a synthetic aminothiols antioxidant used in medicine as a mucolytic agent with the aim of reducing the viscosity of pulmonary secretions in a variety of respiratory illnesses. Intravenous administration of NAC is used extensively in the management of paracetamol (acetaminophen) poisoning [1]. Kinetic spectrophotometry was employed for the development of a new method for determination of NAC in pharmaceutical formulations. The proposed method is based on a redox reaction in which the reduction of copper(II)-bathocuproine disulphonate occurs by NAC with formation of orange coloured copper(I)-bathocuproine disulphonate complex. This stable complex exhibits an absorption maximum at $\lambda = 483$ nm. The parameters of chemical reaction have been optimized. The proposed method was validated in terms of linearity range, limit of detection and limit of quantitation, selectivity, precision and accuracy. Using kinetic spectrophotometric measurements, initial rate and fixed time methods were utilized for constructing the calibration graphs. For the fixed time method, the graph was linear in the concentration range from 3×10^{-7} mol L⁻¹ to 7×10^{-5} mol L⁻¹ with the limit of detection 8×10^{-8} mol L⁻¹ obeying the equation $y = 13140x - 0.0005$ with the correlation coefficient $R^2 = 0.9999$. For the initial rate method, the graph was linear in the concentration range from 7×10^{-7} mol L⁻¹ to 7×10^{-5} mol L⁻¹ with the limit of detection 2×10^{-7} mol L⁻¹, equation $y = 1.040x + 3.220$ and correlation coefficient $R^2 = 0.9991$. No interferences were observed from the excipients commonly present in pharmaceutical formulations. The proposed methods were successfully applied for the determination of NAC in its commercial pharmaceutical formulations. The results were compared favourably with those obtained by their Pharmacopeial methods.

References

- [1] G. S. Kelly, *Altern. Med. Rev.* **3** (1998) 114-127.

Antiproliferative activity of amidino substituted benzimidazoles and benzothiazoles explored by 2D and 3D cell culture system

Antiproliferativna aktivnost amidino supstituuiranih benzimidazola i benzotiazola ispitana na 2D i 3D staničnim linijama

Maja Cindrić,¹ Livio Racané,² Nataša Perin,¹ Ida Boček,¹ Anja Beč,¹ Ivo Zlatar,³
Karmen Brajša,³ Marijana Hranjec¹

¹Department of Organic Chemistry, Faculty of Chemical Engineering and Technology, University of Zagreb, Zagreb, Croatia

²Department of Applied Chemistry, Faculty of Textile Technology, University of Zagreb, Zagreb, Croatia

³Pharmacology in vitro, Fidelta Ltd., Zagreb, Croatia

E-mail: mcindric@fkit.hr

It is well known that amidines are structural parts of numerous compounds of biological interest including important medical and biochemical agents. Amidine substituents placed at the termini of the molecule have great importance in the molecule – biological target interactions allowing the formation of the stable complex with biological molecules. In our previous studies we have proved that by engrafting amidine extremities as positively charged substituents at the end of the heteroaromatic substructures we could significantly improve the biological activity and orient the function of the molecule toward the binding to an electronegatively charged biological molecule such as DNA [1].

This work presents the synthesis of amidino substituted benzimidazoles and benzothiazoles as potential biologically active agents. For the synthesis of novel targeted compounds classical organic synthesis reactions were used. Antitumor activity in 2D and 3D cancer cell culture assays on three human lung cancer cell lines (A549, HCC827, NCI-H358) was tested. Doxorubicin, staurosporine and vandetanib were used as control compounds [2].

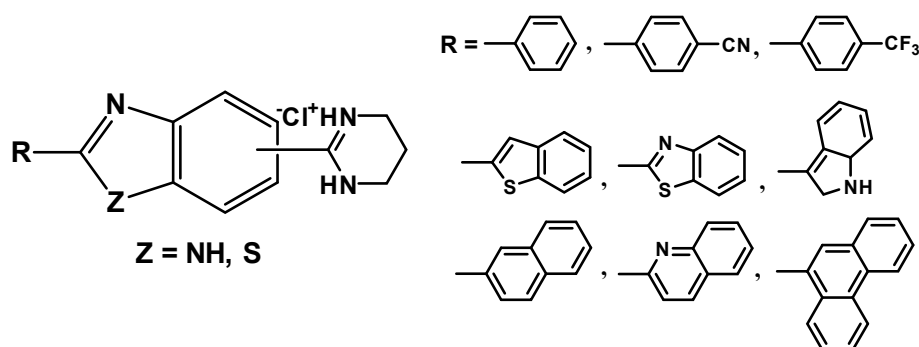

Figure 1: Amidino substituted benzimidazoles and benzothiazoles.

References

- [1] M. Cindrić, S. Jambon, A. Harej, S. Depauw, M.-H. David-Cordonnier, S. Kraljević Pavelić, G. Karminski-Zamola and M. Hranjec, *Eur. J. Med. Chem.* **136** (2017) 468-479.
[2] I. Zlatar, D. Jelić, V. Kelava, M. Cindrić, I. Jarak, S. Koštrun, G. Karminski-Zamola, V. Gabelica Marković, M. Hranjec and K. Brajša, *Croat. Chem. Acta* **90** (2017) 413-424.

Acknowledgment: This work was funded by the Croatian Science Foundation (HRZZ-4379, AntioxPot).

Spectroscopic properties and immobilisation of fluorescent amino substituted benzimidazo[1,2-*a*]quinolines

Spektroskopske karakteristike i imobilizacija fluorescentnih amino supstituiranih benzimidazo[1,2-*a*]kinolina

Marijana Hranjec,¹ Nataša Perin,¹ Ema Horak,² Ivana Murković Steinberg,³ Darko Babić,² Robert Vianello²

¹Department of Organic Chemistry, Faculty of Chemical Engineering and Technology (FCET), University of Zagreb (UZ), Zagreb, Croatia

²Ruđer Bošković Institute, Zagreb, Croatia

³Department of General and Inorganic Chemistry, FCET, UZ, Croatia

E-mail: mhranjec@fkit.hr

Recently, one of the extensively studied classes of organic fluorescent sensors is that based on benzimidazole nuclei [1]. Due to the highly conjugated planar chromophore, the benzimidazole benzannulated derivatives offer promising applications in optoelectronics, optical lasers, fluorescence probes and organic luminophores [2]. Presented amino substituted benzimidazo[1,2-*a*]quinolines designed as fluorescence sensors to determine pH changes, possess also interesting spectroscopic properties. The studied benzimidazo[1,2-*a*]quinolines enable internal charge transfer (ICT) interactions, causing expressed pH sensing properties. It was noticed that the type and position of amino substituent placed at the tetracyclic skeleton strongly influenced absorption and emission. Moreover, upon acidification, the push-pull character of the ICT transition is enhanced in all aminated fluorescent dyes. Computational analysis complemented experiments, by elucidating acid-base and excited-state features of investigated systems, thus aided in the determination of protonation forms present in solution and interpretation of the electronic transitions.

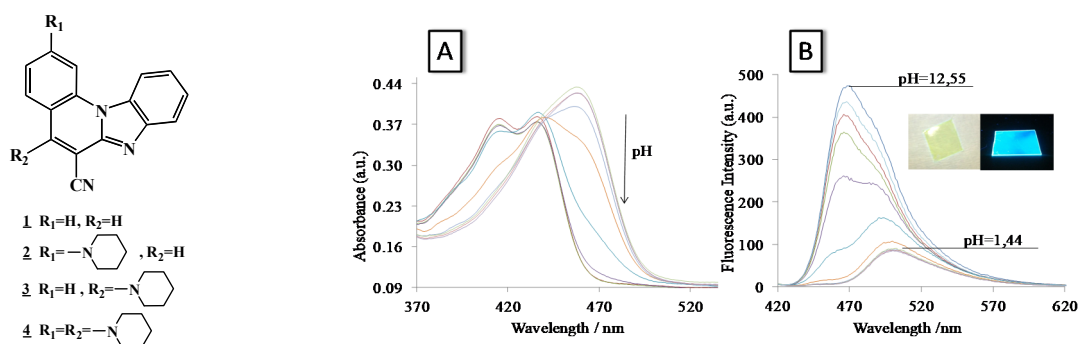

Figure 1: Effect of pH on A) absorption and B) fluorescence spectra of compound **2** immobilised in plasticised PVC films. Inset: thin film observed by daylight and under UV lamp.

References

- [1] E. Horak, M. Robić, A. Šimanović, V. Mandić, R. Vianello, M. Hranjec and I. Murković-Steinberg, *Dyes Pigm.* **162** (2019) 688-696.
- [2] a) M. Hranjec, E. Horak, D. Babić, S. Plavljanić, Z. Srdović, I. M. Steinberg, R. Vianello and N. Perin, *New J. Chem.* **41** (2017) 358-371; b) E. Horak, R. Vianello, M. Hranjec and S. Krištafor, *Spectrochim. Acta A, Mol. Biomol. Spectros.* **178** (2017) 225-233.

Acknowledgment: This work was funded by the Croatian Sci. Found. (project HRZZ-3386, iNFINITE-SENS).

Copper(II) complex with carnosine Kompleks bakra(II) s karnozinom

Marina Tašner, Draginja Mrvoš-Sermek, Dubravka Matković-Čalogović
Department of Chemistry, Faculty of Science, University of Zagreb, Zagreb, Croatia

E-mail: mtasner@chem.pmf.hr

Carnosine (β -alanyl-L-histidine) is an endogenous dipeptide abundantly present in the skeletal muscles and in the brain, and has numerous beneficial effects such as antioxidant, anti-crosslinking, anti-glycation activities and metal chelating [1]. Carnosine forms complexes with copper, zinc, cobalt, vanadium, nickel and manganese ions [2]. The Cu(II)-carnosine system has been largely investigated by different experimental techniques, mostly in solution, and as a result of these measurements two basic structural types were proposed: monomeric and dimeric (Figure 1) [3]. In 1967, Freeman and Szymanski [4] have synthesized a Cu(II) complex by the interaction of an alkaline solution of $\text{Cu}(\text{OH})_2$ and carnosine and described its crystal structure as a dimer. Other proposed structures of Cu(II) carnosine complexes have not been described in the solid state.

In our investigation, copper(II) complex with carnosine, $[\text{Cu}_2(\text{car}^{2-})_2(\text{H}_2\text{O})_2] \cdot \text{H}_2\text{O}$ was synthesized by the liquid-assisted grinding method (H_2O) from copper(II) hydroxide and carnosine. Single crystals were obtained by recrystallization from a 0.1 mol dm^{-3} NaOH solution. The X-ray analysis (trigonal system, space group $P3_121$, $a = 8.5659(4)$, $c = 30.5847(10)$ Å) confirmed the dimeric structure of the complex (Figure 2). We are also investigating conditions for the preparation of monomeric crystalline products.

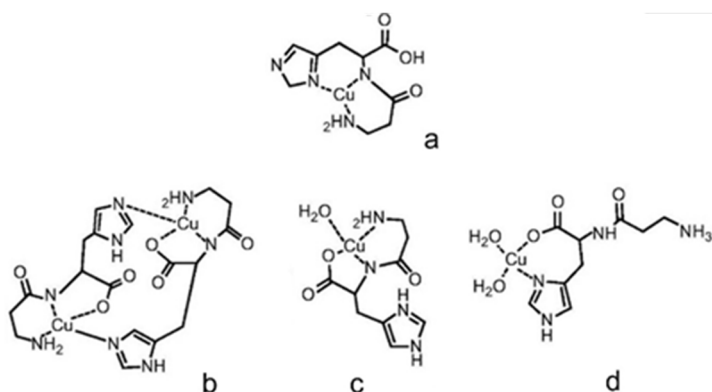

Figure 1: Proposed structures of Cu(II) carnosine (car) complexes: a) $[\text{Cu}(\text{car}^{2-})]$, b) $[\text{Cu}_2(\text{car}^{2-})_2]$, c) $[\text{Cu}(\text{car}^-)(\text{H}_2\text{O})]^+$, d) $[\text{Cu}(\text{car})(\text{H}_2\text{O})_2]^{2+}$ [3].

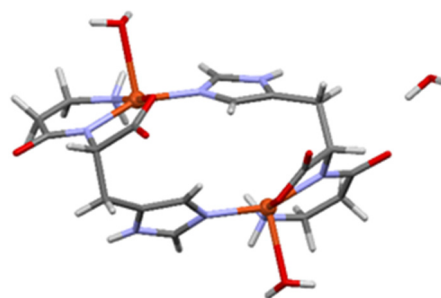

Figure 2: Structure of $[\text{Cu}_2(\text{car}^{2-})_2(\text{H}_2\text{O})_2] \cdot \text{H}_2\text{O}$.

References

- [1] M. Kawahara, K. Tanaka and M. Kato-Negishi, *Nutrients* **10** (2018) 147-167.
- [2] E. J. Baran, *Biochemistry (Moscow)* **65** (2000) 789-797.
- [3] A. A. Boldyrev, G. Aldini and W. Derave, *Physiol Rew.* **93** (2013) 1803-1845.
- [4] H. C. Freeman and J. T. Szymanski, *Acta Cryst.* **22** (1967) 406-417.

Supramolecular structure of new phenacyloxime derivative of piridoxal oxime Supramolekulska struktura novog fenaciloksimskog derivata piridoksal-oksima

Mario Cetina,¹ Dajana Gašo Sokač,² Valentina Bušić²

¹University of Zagreb, Faculty of Textile Technology, Department of Applied Chemistry, Zagreb, Croatia

²Josip Juraj Strossmayer University of Osijek, Faculty of Food Technology Osijek, Osijek, Croatia

E-mail: mario.cetina@ttf.hr

In the past few decades, a whole series of aliphatic, aromatic and heterocyclic oximes have been synthesized and tested as antidotes in poisoning with organophosphorus compounds (OPC). Among them only mono- and bis-pyridinium compounds possessing an oxime group in position 2 and 4 (PAM-2, TMB-4, HI-6) have been used in human therapy. Reactivating action of these compounds is due to the quaternary nitrogen of the pyridine ring and to the oxime groups which make possible the rupture of the phosphorylated enzyme and its reactivation. Compounds that possess quaternary pyridinium nitrogen and an oxime group, but in the aliphatic part of the molecule, are also synthesized. Malatesta *et al.* have synthesized 1-phenacyloxime quinoline chloride, which proved to be a better *in vitro* reactivator of cholinesterase inhibited by sarin than PAM-2. Binenfeld *et al.* synthesized derivatives of 1-phenacyloxime quinoline chloride and showed that the replacement of the pyridine ring by quinoline analogue produces an enhancement of its inhibitory effect on ChE and also makes it possible to reactivate ChE inhibited by sarin [1]. Hankonyi *et al.* prepared 1-phenacyloxime-pyridinium chloride and 2-methyl and 4-methylpyridinium derivatives [2]. In this work we present supramolecular structure of new dioxime, 3-hydroxy-1-((2-(hydroxyimino)-2-phenylethyl)-4-(hydroxyiminomethyl)-5-(hydroxymethyl)-2-methylpyridin-1-ium bromide (**1**), prepared by quaternisation of pyridoxaloxime with phenacyloxime bromide (Figure 1a). It will be shown that cations and anions in **1** form a complex network of hydrogen bonds and a three-dimensional network (Figure 1b).

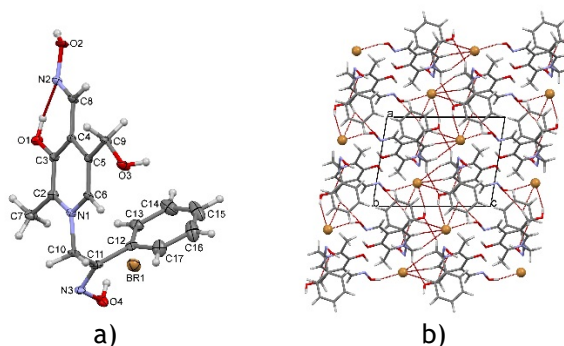

Figure 1: (a) Molecular structure of **1**, with the atom numbering scheme. (b) A part of the crystal structure of **1**, showing complex network of hydrogen bonds which form three-dimensional network.

References

- [1] Z. Binenfeld, V. Deljac, M. Knežević, Lj. Pavlov, M. Maksimović, V. Markov, Lj. Radović and D. Rakin, *Acta Pharm Jugosl.* **31** (1981) 5-15.
[2] V. Hankonyi, Z. Binenfeld and V. Karas-Gašparec, *Croat. Chem. Acta* **44** (1972) 329-340.

Synthesis of coumarinyl 1,2,4-triazoles in deep eutectic solvents Sinteza kumarinskih derivata 1,2,4-triazola u eutektnim otapalima

Mario Komar, Melita Lončarić, Maja Molnar

Josip Juraj Strossmayer University of Osijek, Faculty of Food Technology Osijek, Osijek, Croatia

E-mail: Mario.Komar@ptfos.hr

1,2,3-triazole and 1,2,4-triazole are two isomers of five-membered nitrogen containing heterocyclic compound. 1,2,4-triazole derivatives are biologically active components with many human health positive effects (antibacterial, antifungal, antitumor, anticonvulsant, anti-inflammatory, antimicrobial). There are many methods for 1,2,4-triazole synthesis, but most of them include organic solvents and catalysts which are toxic [1]. In this research deep eutectic solvents (DESs) are used as tunable media for chemical synthesis of desired compounds. DESs are environmental-friendly solvents due to their properties (non-toxic, low vapor pressure, biodegradability, chemical stability) [2].

A reaction of 2-((4-methyl-2-oxo-2H-chromen-7-yl)oxy)acetohydrazide and phenyl isothiocyanate (Scheme 1) was performed in 14 different choline chloride based DESs and at two different temperatures (40 °C and 80 °C). In choline chloride : urea (1:2) and choline chloride : *N*-methyl urea (1:3) DESs at 80 °C pure 1,2,4-triazole was obtained. At 40 °C, in choline chloride : ethane-1,2-diol (1:2), choline chloride : malic acid (1:1), choline chloride : malonic acid (1:1), choline chloride : butane-1,4-diol (1:3) and choline chloride : glycerol (1:2) pure thiosemicarbazide was obtained. The temperature as well as the type of deep eutectic solvent significantly affected the compound formation.

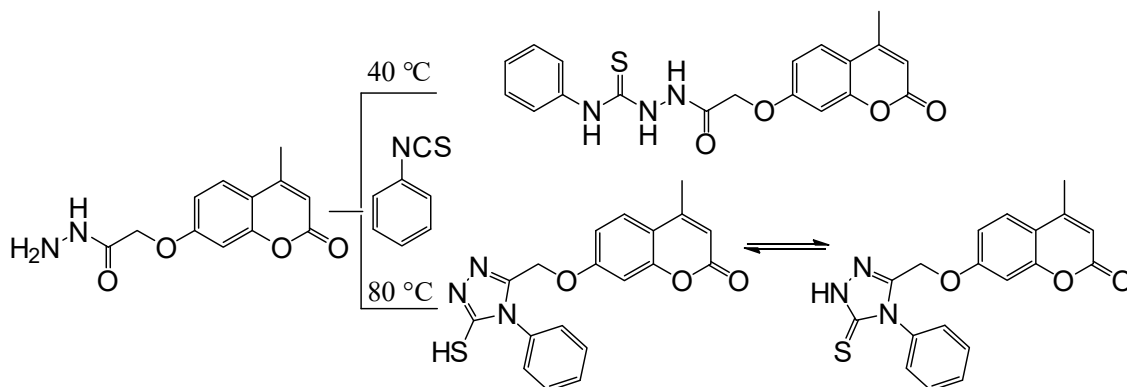

Scheme 1: A model reaction in synthesis of 1,2,4-triazoles performed in different DESs.

References

- [1] S. C. Holm and B. F. Straub, *Org. Prep. Proc. Int.* **43** (2011) 319-347.
- [2] A. P. Abbott, D. Boothby, G. Capper, D. L. Davies and R. K. Rasheed, *J. Am. Chem. Soc.* **126** (2004) 9142-9147.

Influence of butanol on renewable and mineral diesel fuel mixture properties

Utjecaj butanola na svojstva mješavina obnovljivog i mineralnog dizelskog goriva

Mario Pipunić,¹ Ivan Pucko,¹ Lucija Rebrović,¹ Lucija Kurte,² Fabio Faraguna,¹ Ante Jukić¹

¹Fakultet kemijskog inženjerstva i tehnologije, Sveučilište u Zagrebu, Zagreb, Hrvatska

²INA-Industrija nafte d.d., Zagreb, Hrvatska

E-pošta: mpipunic@fkit.hr

Zahvaljujući unaprijeđenom postupku proizvodnje, biobutanol se razmatra i sve više upotrebljava kao obnovljivo i zamjensko gorivo za motore s unutarnjim izgaranjem [1]. Osim izravne upotrebe i namješavanja s mineralnim motornim gorivima, biobutanol se može koristiti i kao alkohol u procesu transesterifikacije otpadnih biljnih ulja pri proizvodnji biodizela [2]. Radi postizanja veće konverzije proces transesterifikacije često se vodi u velikom suvišku alkohola, kojega naknadno treba ukloniti ako je riječ o metanolu. Svrha ovoga rada bila je istražiti utjecaj ostatnog butanola na svojstva mješavina butilnih estera viših masnih kiselina (FABE, *fatty acid butyl ester*) s mineralnim dizelskim gorivom. Ispitivanja gustoće, kinematičke viskoznosti, niskotemperaturne filtrabilnosti i mazivosti za istražene mješavine do FABE udjela od 10 vol. % i do udjela butanola od 5 vol. % pokazala su da nema njegova lošeg utjecaja na zahtijevane vrijednosti goriva. Prema utvrđenim utjecajima može se zaključiti da nereagirani butanol nije potrebno odvajati iz smjese produkata transesterifikacije. Na taj se način postiže ušteda energije i ostalih resursa koji bi bili potrebni za njegovo izdvajanje iz smjese. Naravno, prije same uporabe mješavina, potrebno je istražiti i dodatna svojstva zadana normom o kvaliteti dizelskog goriva (HR EN 590), kao i emisije ispušnih plinova iz motora s unutarnjim izgaranjem.

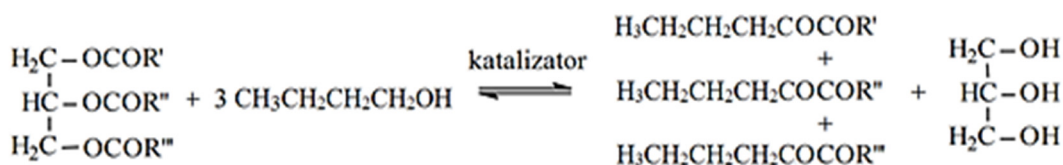

Slika 1: Reakcija transesterifikacije.

Reference

- [1] W. R. da Silva Trindade i R. G. dos Santos, *Renew. Sust. Energy Rev.* **69** (2017) 642-651.
[2] F. Faraguna, M. Racar, Z. Glasovac i A. Jukić, *Energy Fuels* **31** (2017) 3943-3948.

Estimation of solubility of bioactive compounds from Mediterranean plants in “green” solvents and natural deep eutectic solvents by COSMO-RS software Procjena topljivosti bioaktivnih spojeva mediteranskog bilja u “zelenim” i prirodnim niskotemperaturnim eutektičnim otapalima softverom COSMO-RS

Marko Viskić,¹ Njara Rakotomanomana,² Farid Chemat,²
Marko Vinceković,¹ Anet Režek-Jambrak³

¹Chemistry Department, Faculty of Agriculture, University of Zagreb, Zagreb, Croatia

²INRA, GREEN Extraction Team, University of Avignon, Avignon, France

³Laboratory for Food Processes Engineering, Department of Food Engineering, Faculty of Food Technology and Biotechnology, Zagreb, Croatia

E-mail: mviskic@agr.hr

Choice of an appropriate solvent is among the crucial steps in the development of a liquid-liquid extraction method. The procedure can be simplified by using software for modeling and evaluation of thermodynamic properties such as COSMO-RS, which calculates a multitude of solvation parameters in the absence of experimental data [1]. Solubility prediction was performed under different initial conditions for a group of bioactive components from Mediterranean plants in 15 selected “green” solvents with *n*-hexane as the reference solvent. A general solvation behavior of the screened solvents was established as follows: CPME (cyclopropyl methyl ether), 2-MeTHF > ethyl acetate > butan-1-ol, *i*-propanol, ethanol > glycerol > menthyl acetate, ethyl oleate > other terpenes. MeTHF and CPME were previously reported as excellent alternative solvents for the extraction of natural products [2]. Solubility prediction was also performed for four selected natural deep eutectic solvents (NaDES) by additive approach [3] and approach [4] which involved optimization of the structure of the intermolecular complex. According to both approaches, the investigated systems represent ideal solvents for moderately lipophilic compounds, while being unsuitable for extraction of the most lipophilic ($\log P \geq 4$) compounds.

References

[1] A. Klamt, *J. Phys. Chem.* 99 (1995) 2224-2235.

[2] M. Vian, C. Breil, L. Vernes, E. Chaabani and F. Chemat, *Curr. Opin. Green Sustain. Chem.* 5 (2017) 44-48.

[3] M. Viskić and J. Reinisch, personal correspondence, 18th September 2018.

[4] H. F. Hizaddin, A. Ramalingam, M. A. Hashim and M. K. O. Hadj-Kali, *J. Chem. Eng. Data* 59 (2014) 3470-3487.

Extraction of rutin and rosmarinic acid from *Satureja montana* L. with deep eutectic solvents

Ekstrakcija rutina i ružmarinske kiseline iz primorskog vriska (*Satureja montana* L.) primjenom eutektičnih otapala

Martina Jakovljević,¹Jelena Vladić,² Maja Molnar,¹ Stela Jokić¹

¹Faculty of Food Technology Osijek, Josip Juraj Strossmayer University, Osijek, Croatia

² Faculty of Technology, University of Novi Sad, Serbia

E-mail: mjakovljevic@ptfos.hr

Given the growing use of bioactive components in the industry, the development of new and green methods for their extraction is crucial. Solvents play an important role in chemical process of mass and heat transfer so selecting suitable solvents is one of the most important steps in the extraction process. Deep eutectic solvents (DESs), which are composed of a hydrogen bond acceptor (HBA) (usually choline chloride) and hydrogen bond donor (HBD) components, stand out as a promising substitution to conventional solvents due to their great properties as non-toxicity, thermal stability, easy preparation, biodegradability and low price of components.

Satureja montana is an aromatic and medicinal plant used in traditional medicine due to composition which include antioxidant components, as well as in cooking as a spice and in the cosmetics industry [1,2].

In this study, a simple extraction method based on DES was used for the extraction of rutin and rosmarinic acid from *Satureja montana* L. Five different choline chloride based deep eutectic solvents (urea, sorbitol, butan-1,4 diol, lactic and levulinic acid as HBD) were tested and compared with water as solvent. Besides, the influence of amount of water added (10%, 30%, 50%) and temperatures (30, 50, 70 °C) on the rosmarinic acid and rutin content in extracts was investigated. After extraction, the components were detected and quantified using high performance liquid with diode-array detector (HPLC-DAD).

Among tested DES, choline chloride: lactic acid (1:2) and choline chloride: levulinic acid (1:2) were the most suitable for extraction of rutin, while in the case of rosmarinic acid similar amount was obtained with all of tested solvents. Depending on the parameters and the solvents used, the quantities of extracted rutin ranged from 1.40 to 17.29 $\mu\text{g mg}^{-1}$ of plants, while the quantities of extracted rosmarinic acid ranged from 0.21 to 7.84 $\mu\text{g mg}^{-1}$ of plants. On the other hand, by extraction with water at different temperatures, 5.16 – 6.27 mg^{-1} of rutin and 2.30 – 3.81 $\mu\text{g mg}^{-1}$ of rosmarinic acid was extracted.

The obtained results indicated that deep eutectic solvents could be an alternative to traditional solvents for extraction of rutin and rosmarinic acid from *Satureja montana*.

References

- [1] D. Kuštrak, J. Kulftinec, N. Blažević and M. Maffei, *J. Essent. Oil. Res.* **8** (1996) 7-13.
- [2] A. Sonboli, A. Fakhari, M. R. Kanani and M. Yousefzadi, *J. Biosci.* **59** (2004) 777-781.

Photophysical and photochemical characteristics of free-base and Zn(II) complexes of *N*-methylated tetra- and tripyridylporphyrins
Fotofizikalna i fotokemijska svojstva slobodne baze i Zn(II) kompleksa *N*-metiliranih tetra- i tripiridilporfirina

Martina Mušković, Nela Malatesti

Department of Biotechnology, University of Rijeka, Rijeka, Croatia

E-mail: martina.muskovic@student.uniri.hr

Photodynamic therapy (PDT) is a fairly new, non-invasive method used for the destruction of cancer tissue, which can be applied alone or in combination with other therapies such as surgery, chemotherapy or radiotherapy [1]. It is based on a combination of individually non-toxic components, photosensitizer (PS), light and oxygen, which, acting together, can lead to cytotoxic effect.

The most used PSs have tetrapyrrole-based structures, such as porphyrins, chlorins and bacteriochlorins as main representatives. Some of their characteristic photophysical and photochemical properties that are important for PDT encompass stability, strong absorption and fluorescence spectra, and efficient production of singlet oxygen [2].

Another advantage of PS with tetrapyrrole structure is a relatively easy chelation with the pyrrole nitrogen atoms that can lead to modification of photophysical properties and differences in photodynamic activity. It was shown that chelation with Zn(II) can improve photophysical properties of potential tetrapyrrole-based PSs toward longer lifetime of the PSs triplet excited state, increasing the possibility for ³PS* to interact with molecular oxygen and/or cellular targets [3,4].

In our previous work, synthesis and photophysical properties of a series of amphiphilic pyridylporphyrins was described and their PDT activity demonstrated [5]. Our further study that we wish to present here includes a new approach to methylation and chelation of tetra- and tripyridylporphyrins with Zn(II). The photophysical and photochemical properties, notably absorption and fluorescence spectra, singlet oxygen production using 1,3-diphenylisobenzofuran (DPBF) photodegradation method, as well as lipophilicity of the obtained complexes will be presented and described in comparison to their free-base counterparts.

References

- [1] P. Agostinis, K. Berg, K. Chengel, T. Foster, A. Girotti, D. Kessel, M. Korbelik, J. Moan, P. Morz, D. Nowis, J. Piette, B. Wilson and J. Golab, *CA Cancer J. Clin.* **6** (2011) 250-281.
- [2] L. B. Josefsen and R. W. Boyle, *Met. Based Drugs* **2008** (2008) 276109.
- [3] L. Benov, J. Craik and I. Batinic-Haberle, *Anticancer Agents Med. Chem.* **11** (2011) 233-241.
- [4] L. Benov, J. Craik and I. Batinic-Haberle, *Amino Acids* **42** (2012) 117-128
- [5] M. Jelovica, P. Grbčić, M. Mušković, M. Sedić, S. K. Pavelić, M. Lončarić and N. Malatesti, *ChemMedChem*, **13** (2018) 360-372.

Time-resolved electrokinetics study of nascent calcium carbonate precipitate Vremenski razlučena elektrokinetička studija početnog stvaranja taloga kalcijeva karbonata

Marzena Prus,¹ Karolina Szymanek,² Jennifer Mills,³ Laura Nielsen Lammers,³ Wojciech Piasecki,² Karolina Kedra-Królik,¹ Piotr Zarzycki^{4,1}

¹*Institute of Physical Chemistry, Polish Academy of Sciences, Warsaw, Poland*

²*Department of Chemistry and Biochemistry, Józef Piłsudski University of Physical Education, Warsaw, Poland*

³*Department of Environmental Science, Policy and Management, University of California, Berkeley, California, USA*

⁴*Energy Geosciences Division, Lawrence Berkeley National Laboratory, Berkeley, California, USA*

E-mail: mprus@ichf.edu.pl

Calcium carbonate is one of the most widespread minerals in the Earth, present in many sedimentary basins as limestone or marbles [1]. However, understanding of its formation, stability, and dynamics remain a challenge due to the plethora of possible and often concurrent transformation pathways [1].

In this presentation, we focus on CaCO₃ precipitation from a slightly supersaturated aqueous solution. Crystal formation and growth are driven by the minimization of free energy, and primarily controlled by solution saturation [2]. We show the results of multistage carbonate nucleation with signatures in both aqueous solution and electrokinetic potential. The time-dependent evolution of ξ -potential, particles morphology, solution pH and composition are consistent with the spontaneous formation of vaterite, and its subsequent transformation to calcite *via* the dissolution-precipitation pathway (see Figure 1) [3].

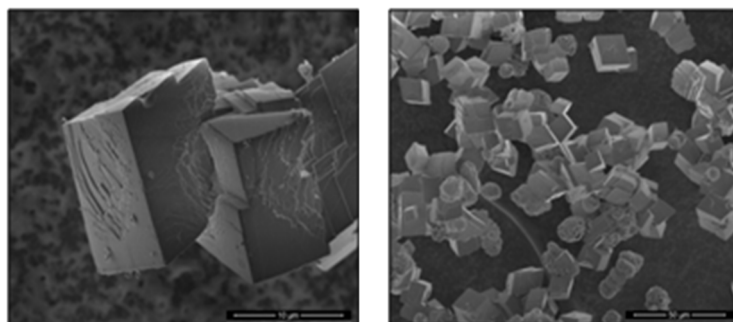

Figure 1: Scanning electron microscopy (SEM) showing the presence of the calcite (rhombohedral morphology) and vaterite intermediates (spherulitic morphology) particles.

References

- [1] W. F. Tegethoff, *Calcium Carbonate: From the Cretaceous Period Into the 21st Century*, Springer, Basel (2001).
- [2] A. V. Radha and A. Navrotsky, *Rev. Mineral. Geochem.* **77** (2013) 73-121.
- [3] M. Prus, K. Szymanek, J. Mills, L. N. Lammers, W. Piasecki, K. Kedra-Królik and P. Zarzycki, *J. Colloid Interface Sci.* (2019) submitted.

Acknowledgment: This work was supported by the NCN Grant Sonata Bis (UMO-2016/22/E/ST4/00446).

Competitive formation of halogen and hydrogen-bonded cocrystals by liquid-assisted grinding

Kompetitivno nastajanje kokristala temeljenih na halogenskoj ili vodikovoj vezi u mehanokemijskim reakcijama potpomognutima kapljevnom

Matea Vitković, Vladimir Stilinović, Dominik Cinčić

Department of Chemistry, Faculty of Science, University of Zagreb, Zagreb, Croatia

E-pošta: matea.vitkovic@chem.pmf.hr

Mehanokemijska sinteza kokristala koji se temelje na vodikovim ili halogenskim vezama pruža jedinstvenu priliku sinteze u čvrstom stanju [1]. Za razliku od kokristalizacije iz otopine, mehanokemijska sinteza je brza, velikog iskorištenja i lako joj se može kontrolirati ishod [2]. Iako se pokazalo da dodatak male količine kapljevine može bitno ubrzati reakciju (LAG) [3], utjecaj vrste kapljevine na ishod kompetitivnih supramolekulskih reakcija slabo je istražen.

U ovom priopćenju opisuje se kapljevnom potpomognuto mljevenje smjesa 1,2-(bis(4-piridil)etana (ditopični akceptor vodikove ili halogenske veze) s ditopičnim donatorom halogenske veze (1,4-dijodtetrafluorbenzenom ili 1,4-dijodbenzenom) i ditopičnim donatorom vodikove veze (hidrokinonom ili tetrafluorhidrokinonom) u stehiometrijskom omjeru 1:1:1, kako bi se ustanovilo hoće li nastati kokristal s halogenskom ili vodikovom vezom, ovisno o odabiru potpomagajuće kapljevine. Za svaku smjesu korišteno je petnaestak kapljevina različitih polarnosti (od alifatskih ugljikovodika do vode). Budući da su Brammer i suradnici za odabrane sustave donora i akceptora ustanovili jak utjecaj otapala na ishod kokristalizacije iz otopine (polarnija otapala favoriziraju kokristale s halogenskom, a manje polarna s vodikovom vezom) [4], smatralo se da su ovi sustavi idealni za izučavanje utjecaja dodatka potpomagajuće kapljevine na ishod mehanokemijskog pokusa. Produkti mljevenja analizirani su difrakcijom rentgenskog zračenja na praškastom uzorku, diferencijalnom skenirajućom kalorimetrijom i IR-ATR spektroskopijom. Dobiveni podatci uspoređivani su s rezultatima kokristalizacije iz otopine. Ustanovljeno je da, neovisno o polarnosti potpomagajuće tekućine, mljevenjem smjese jakog donora halogenske veze (1,4-dijodtetrafluorbenzena), akceptora i hidrokinona uvijek nastaje kokristal temeljen na halogenskim vezama (donor vodikove veze ostaje neizreagiran u smjesi), dok mljevenjem smjese s tetrafluorhidrokinonom nastaje kokristal temeljen na vodikovoj vezi (donor halogenske veze ostaje neizreagiran u smjesi). Nasuprot tome, u svim pokusima mljevenja s 1,4-dijodbenzenom on ostaje neizreagiran te nastaju kokristali temeljeni na vodikovoj vezi. Može se zaključiti da za razliku od supramolekulske sinteze u otopini, pri mehanokemijskoj supramolekulske sintezi dodatak kapljevina ubrzava nastanak kokristala, ali ne utječe na konačni ishod.

Reference

- [1] T. Friščić i W. Jones, *Cryst. Growth Des.* **9** (2009) 1621-1637.
- [2] S. L. James i ostali, *Chem. Soc. Rev.* **41** (2012) 413-447.
- [3] T. Friščić, *Chem. Soc. Rev.* **41** (2012) 3493-3510.
- [4] C. C. Robertson, J. S. Wright, E. J. Carrington, R. N. Perutz, C. A. Hunter i L. Brammer, *Chem.Sci.* **8** (2017) 5392-5398.

NMR and computational study of *N7/N9* transacylation in ferrocenoyl-purines NMR i kvantno-kemijska studija *N7/N9* transaciliranja ferocenoil-purina

Mateja Toma,¹ Lucija Božičević,¹ Jasmina Lapić,² Senka Djaković,² Davor Šakić,¹ Valerije Vrčec¹

¹Faculty of Pharmacy and Biochemistry, University of Zagreb, Zagreb, Croatia

²Faculty of Food Technology and Biotechnology, University of Zagreb, Zagreb, Croatia

E-mail: mtoma@pharma.hr

Organometallic derivatives of nucleobases have attracted substantial attention in the field of synthetic organic chemistry. Nucleosides in which sugar part is replaced with organometallic moiety, such as ferrocene, combine electro- and bio-active fragments and are shown to exhibit anticancer and antibacterial activity [1].

We have prepared a series of *N*-ferrocenoylated *C6*-substituted purines with carbonyl group as a linker [2] between the two parts. In the course of reaction two isomers were formed, isolated and assigned to *N7* and *N9*, with the ratio dependent on substituents of the purine ring. However, in common polar organic solvents, *e.g.* DMSO and DMF, at room temperature, *N7/N9* transacylation occurs and the two isomers exist in dynamic equilibrium. Combining the experimental (NMR) and theoretical (DFT) study, we were able to determine the mechanism of *N7/N9* transacylation. We found that this is a common process in acylated (non-organometallic) purines. The transacylation reaction in purines starts with the nucleophilic addition of DMSO to the carbonyl group at the *N7*-position and follows the S_N2 -like mechanism (Figure 1.). Gibbs free energy barriers calculated at the B3LYP/6-31G(d)/SDD and M06L/6-311+G(d,p)/SDD level agree well with experimental ($\Delta G^\ddagger \approx 100$ kJ mol⁻¹) data and support the proposed transacylation mechanism (Figure 1.).

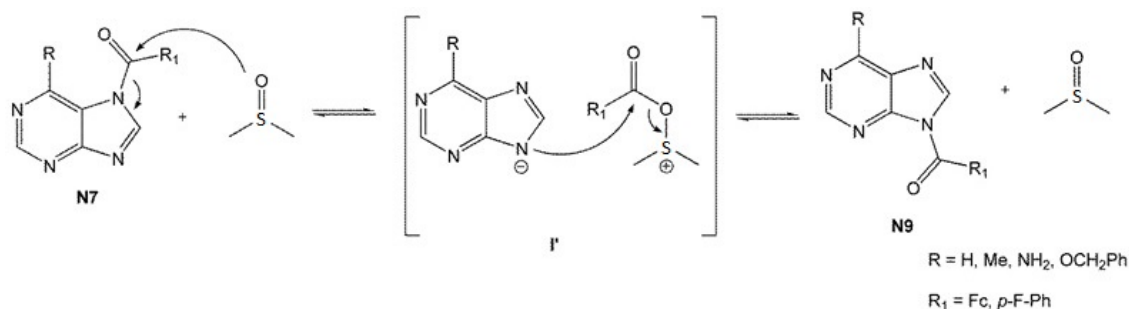

Figure 1: DMSO assisted *N7/N9* transacylation in ferrocenoyl (and acyl) purines.

References

- [1] K. Kowalski, *Coord. Chem. Rev.* **317** (2016) 132-156.
[2] J. Lapić, V. Havaić, D. Šakić, S. Djaković, K. Sanković and V. Vrčec, *Eur. J. Org. Chem.* (2015) 5424-5431.

Development and validation of UPLC-MS/MS method for the determination of genotoxic impurities in Ceritinib active pharmaceutical ingredient

Razvoj i validacija UPLC-MS/MS metode za određivanje genotoksičnih onečišćenja u ceritinibu

Mia Antolčić,¹ Mislav Runje,¹ Nives Galić,² Vedrana Jurković^{2,3}

¹TAPI Analitika R&D, PLIVA Hrvatska d.o.o., Zagreb, Hrvatska

²Kemijski odsjek, Prirodoslovno-matematički fakultet, Sveučilište u Zagrebu, Zagreb, Hrvatska

³R&D, Chromos-Svjetlost, Lužani, Hrvatska

E-mail: Mia.Antolcic@pliva.com

Potential genotoxic impurities (PGIs) are impurities that have a structural alert related to genotoxicity, whereas genotoxic impurities (GTIs) are PGIs that were proved to be genotoxic during toxicological assessment [1]. Both pharmaceutical industries and regulatory agencies have recognized the importance of GTIs in human health and regulatory issues related to the presence of GTIs in new drug formulations have been released in the last decade by the European Medicines Agency and U.S. Food and Drug Administration. Current regulatory issues are also included in the Pharmaceutical Research and Manufacturing Association. Threshold of Toxicological Concern was established and refers to a threshold exposure level of 1.5 µg/day, which is considered to be associated with an acceptable risk.

Ceritinib (Figure 1) is a molecule that acts as an inhibitor of anaplastic lymphoma kinase (ALK) [2]. This pharmaceutical is therefore used to treat a specific type of lung cancer. Based on the maximum daily dosage of ceritinib (750 mg), the estimated permitted level of these impurities in ceritinib API is 2 ppm/day. In this work, an accurate, selective, precise and robust method was developed and validated for the quantitative determination of four genotoxic impurities in ceritinib by high performance liquid chromatography – tandem mass spectrometry (HPLC-MS/MS). Method was linear for four analyzed impurities in the range from 0.5 ng mL⁻¹ to 100 ng mL⁻¹, with detection and quantification limits of 0.5 ng mL⁻¹ and 1 ng mL⁻¹, respectively.

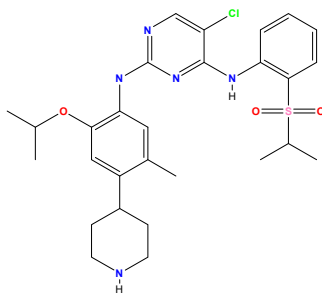

Figure 1: Ceritinib – active pharmaceutical ingredient.

References

- [1] D. Jacobson-Kram and T. McGovern, *Adv. Drug Deliv. Rev.* **59** (2007) 38-42.
- [2] A. T. Shaw et al., *Lancet Oncol.* **18** (2017) 874-886.

Development of continuous crystallization process using single stage mixed-suspension, mixed product removal crystallizer (MSMPR)

Razvoj procesa kontinuirane kristalizacije upotrebom jednostupanjskog kristalizatora s miješanjem suspenzije i uklanjanjem nastalog proizvoda

Mihaela Tuksar, Moris Mihovilović, Ivica Grebenar, Dražen Čavuzić
PLIVA Croatia Ltd., TAPI Research and development, Zagreb, Croatia

E-mail: mihaela.tuksar@pliva.com

Transition from batch crystallization to continuous crystallization gains more and more attention in pharmaceutical production [1,2]. Main disadvantage of batch crystallization, product variability, could be reduced by continuous crystallization due its stable conditions and operation at steady state. For pharmaceutical application, mixed-suspension, mixed product removal (MSMPR) crystallizers in single or multiple stage is the mostly used approach [3,4]. It represents simple, yet efficient way to crystallize the desired product in a continuously fed crystallizer and continuously removed output of the suspension on the isolation equipment.

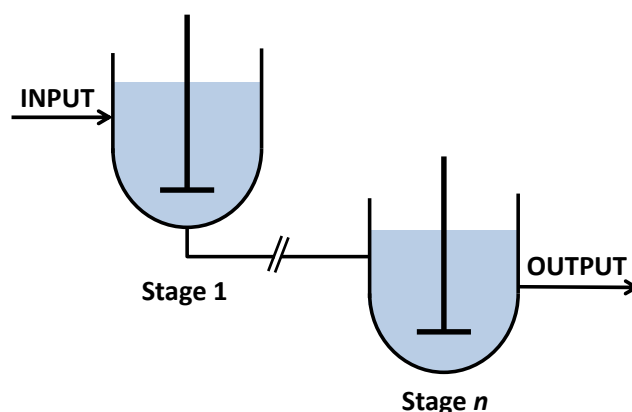

Figure 1: Schematic diagram of a MSMPR crystallizer.

When coupled with various in line methods for monitoring (PAT), continuous crystallization can be fully controlled, robust and commercially scaled up.

In this study, a batch production procedure of an API is successfully transferred to a lab scale antisolvent crystallization using a single stage MSMPR system. Additional work was done concerning in line control of the crystallization and achievement of steady state. FBRM and UV measurements were conducted for better understanding of continuous crystallization. We will demonstrate a very simple but effective setup of the single stage MSMPR constructed from already available equipment in the lab.

References

- [1] B. Wood, K. Girard, C. Polster, D. M. Croker, *Org. Process Res. Dev.* (2019, just accepted) DOI: 10.1021/acs.oprd.8b00319.
- [2] D. Zhang, S. Xu, J. Wang, J. Gong, *Engineering* **108** (2017) 354-364.
- [3] Q. Su, Z. K. Nagy, C. D. Rielly, *Chem. Eng. Process.* **89** (2015) 41-53.
- [4] S. Y. Wong, A. P. Tatusko, B. L. Trout, A. S. Myerson, *Cryst. Growth Des.* **12** (2012) 5701-5707.

Intrinsic electronic effects in organophosphate leaving groups Intrinsični elektronski efekti u organofosfatnim izlaznim skupinama

Mirela Matić, Bernard Denegri

Faculty of Pharmacy and Biochemistry, University of Zagreb, Zagreb, Croatia

E-mail: mmatic@pharma.hr

Kinetic measurements of solvolysis reactions of benzhydryl substrates (Bh—LG) have revealed that dimethyl phosphate (1) is a better leaving group than related methyl carbonate (3) [1] and acetate (5) [2] for 4 and 5.5 orders of magnitude, respectively. Furthermore, the aromatic variant of the phosphate leaving group, diphenyl phosphate (2), is more reactive than dimethyl phosphate (1) for 2 orders of magnitude. Replacing methyl with phenyl moiety in the carbonate leaving group (3, 4) leads to the increase in reactivity for 1.4 orders of magnitude, while the same structural change has a negligible impact on the reactivity of a carboxylate leaving group (5, 6) [1]. Quantum mechanical calculations performed in the gas phase demonstrate similar relations in stabilities of the mentioned anions toward the benzhydryl carbocation. These results imply that strong orbital stabilizing effects develop on the heterolytic reaction coordinate of organic phosphates (Bh—1 and Bh—2) and finally stabilize both a solvolytic transition state and a free phosphate anion (1, 2). NBO analysis indicates that orbital stabilizing effects in organic phosphates are not localized solely within the phosphinyl moiety ($-\text{PO}_2-$), but rather transfer the anionic charge toward the methoxy moieties in dimethyl phosphate (1) and the phenoxy moieties in diphenyl phosphates (2). Analogously, negative hyperconjugation delocalizes the anionic charge toward alkoxy and aryloxy moieties in alkyl and aryl carbonate anions (3 and 4), respectively [3]. On the other hand, alkyl and aryl moieties in carboxylates (5 and 6) stabilize the anionic charge only by polar effects [2,4].

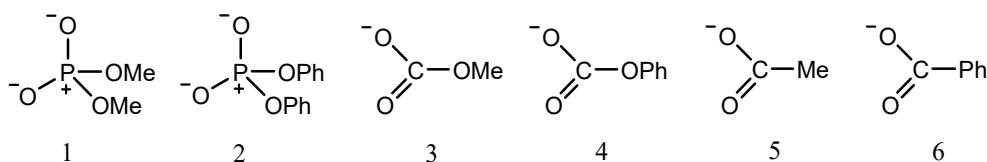

Figure 1: Some leaving groups (LG).

References

- [1] M. Matić, M. Katić, B. Denegri and O. Kronja, *J. Org. Chem.* **82** (2017) 7820-7831.
- [2] M. Matić, B. Denegri and O. Kronja, *Eur. J. Org. Chem.* (2014) 1477-1486.
- [3] B. Denegri, M. Matić and O. Kronja, *ChemistrySelect* **1** (2016) 5250-5259.
- [4] M. Matić, B. Denegri and O. Kronja, *J. Org. Chem.* **77** (2012) 8986-8998.

Complexing of thallium with crown ethers Kompleksiranje talija krunastim eterima

Mirha Pazalija, Mirsada Salihović

Univerzitet u Sarajevu, Farmaceutski fakultet, Sarajevo, Bosna i Hercegovina

E-pošta: mirha.pazalija@ffsa.unsa.ba

Interakcija talija organskim spojevima, kao što su elektroneutralni krunasti eteri koji tvore stabilne komplekse u nevodenim otapalima, zanimljivo je područje istraživanja [1]. Za stabilnost kompleksa, kao i samo kompleksiranje važan čimbenik je omjer veličine šupljine krune etera i ionskog radijusa središnjeg kationa [2]. Kompleksiranje krunastih etera različitim kationima u otopinama prati se pomoću nekoliko metoda: UV spektrofotometrijom, konduktometrijom, potenciometrijom, polarografijom i drugima [3]. Kompleksiran je Tl^+ trima različitim krunastim eterima i to: 18-kruna-6 (18C6), dicikloheksano-18-kruna-6 (DC18C6) i dibenzo-18-kruna-6 (DB18C6). S obzirom na to da su ranija istraživanja pokazala da Tl^+ tvori ionske asocijate uz korištenje pikratnog aniona ($C_6H_2N_3O_7^-$), talijev(I) pikrat ($C_6H_2N_3O_7Tl$) istaložen je u obliku precipitata iz pikrinske kiseline ($C_6H_3N_3O_7$) i talijeva(I) karbonata (Tl_2CO_3). Otopine krunastih etera pripremljene su u acetonitrilu (25 mM), a potom su uz miješanje dodane otopini $C_6H_2N_3O_7Tl$ (0.5 mM). Za ispitivanje kompleksiranja Tl^+ korištene su konduktometrijska i spektrometrijska metoda. Konduktometrijom je ispitano kompleksiranje dvije različite soli talija: talijeva(I) nitrata ($TlNO_3$) i $C_6H_2N_3O_7Tl$ navedenim krunastim eterima. Za nitratni anion (NO_3^-), početna provodnost bila je veoma niska, pri dodavanju otopina krunastog etera dolazi do povećanja molarne provodnosti. Suprotan učinak uočen je korištenjem $C_6H_2N_3O_7^-$, gdje pri dodatku otopine krunastog etera dolazi do smanjenja molarne provodnosti. Spektrometrijski podatci pokazuju da otopina $C_6H_2N_3O_7Tl$ ima apsorpcijski maksimum kod $\lambda=340$ nm. Dodavanjem krunastih etera otopini $C_6H_2N_3O_7Tl$ dolazi do batokromnog pomaka apsorpcijskog maksimuma, koji je najizraženiji pri dodavanju krunastog etera DB18C6 ($\lambda=378$ nm). Na osnovi promjene molarne provodnosti i batokromnog pomaka apsorpcijskog maksimuma pretpostavlja se da je došlo do kompleksiranja Tl^+ krunastim eterima.

Reference

- [1] M. Fraňska i A. Michalak, *Eur. J. Mass Spectrom.* **24** (2018) 279-288.
- [2] E. Makrlík, P. Toman i P. Vaňura, *Monatsh. Chem. Chem. Mon.* **144** (2013) 919-923.
- [3] K. Akhbari i A. Morsali, *Coord. Chem. Rev.* **254** (2010) 1977-2006.

Synthesis of (\pm)-*trans*-3-amino- β -lactam and its enantioseparation on the new polysaccharide-based chiral stationary phase by HPLC and SFC

Sinteza (\pm)-*trans*-3-amino- β -laktama i njegova enantioseparacija na novoj polisaharidnoj kiralnoj stacionarnoj fazi HPLC-om i SFC-om

Mladenka Jurin, Darko Kontrec, Marin Roje

Center of Excellence for Marine Bioprospecting – BioProCro, Ruđer Bošković Institute, Zagreb, Croatia

E-mail: Mladenka.Jurin@irb.hr

β -lactams, or azetidion-2-ones, are of utmost importance in medicine owing to their broad range of bioactivities [1]. They are the key structural component in the most widely used class of antibiotics, β -lactam antibiotics, such as penicillin, cephalosporin, carbapenem, etc [2]. Apart from their pharmacological purposes, β -lactams are also valuable from a synthetic point of view as they can function as building blocks for the synthesis of numerous biologically active natural compounds [1]. Some of the examples include non-natural amino acids, peptides and peptidomimetics, anti-cancer drug paclitaxel, other taxols and anti-tumor antibiotic lankacidin [3]. β -Lactams can be easily rearranged into five-membered, six-membered, and medium-sized rings, which is in focus of our current research [4]. In conducted research the (\pm)-*trans*-3-phthalimido- β -lactam **2b** was prepared by Staudinger reaction, [2+2] ketene-imine cycloaddition (Scheme 1). In the next step, deprotection of the phthalimido group was carried out affording the desired (\pm)-*trans*-3-amino- β -lactam **3** (Scheme 2). The stereochemistry of this class of β -lactams has already been determined and remains unchanged during this conversion [5]. Enantioseparation of **3** was studied using HPLC and SFC on the new chiral stationary phase based on a very unique polysaccharide, and also on the "golden four" polysaccharide type chiral stationary phases. The obtained results showed that the enantioseparation of **3** achieved by SFC is superior in terms of high resolution and short analysis time than using conventional HPLC.

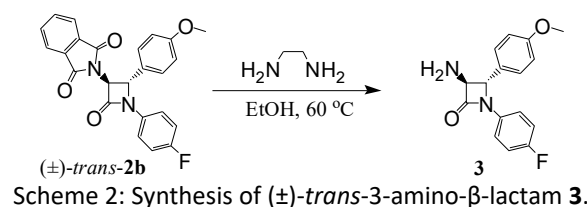
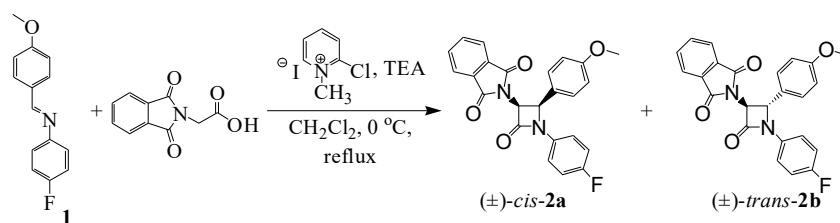

References

- [1] S. Deketelaere, T. Van Nguyen, C. V. Stevens and M. D'hooghe, *ChemistryOpen* **6** (2017) 301-319.
- [2] V. Mehra and V. Kumar, *Tetrahedron Lett.* **54** (2013) 6041-6044.
- [3] T. Dražić and M. Roje, *Chem. Heterocycl. Compd.* **53** (2017) 953-962.
- [4] B. Alcaide, P. Almendros and C. Aragoncillo, *Chem. Rev.* **107** (2007) 4437-4492.
- [5] T. Dražić, M. Roje, M. Jurin and G. Pescitelli, *Eur. J. Org. Chem.* **24** (2016) 4189-4199.

Synthesis and conformational analysis of the conjugate of ferrocene-1,1'-diamine and valine Sinteza i konformacijska analiza konjugata ferocen-1,1'-diamina i valina

Monika Kovačević,¹ Iva Dorić,¹ Mojca Čakić Semenčić,¹ Ivan Kodrin,² Valentina Milašinović,³
Lidija Barišić¹

¹Faculty of Food Technology and Biotechnology, University of Zagreb, Zagreb, Croatia

²Department of Chemistry, Faculty of Science, University of Zagreb, Zagreb, Croatia

³Ruđer Bošković Institute, Zagreb, Croatia

E-mail: monika.kovacevic@pbf.hr

The ability of organometallic conjugates derived from 1,n-disubstituted ferrocenes and Ala to adopt the turn or β -sheet-like structures was extensively studied [1-5]. It was shown that hydrogen-bond donor/acceptor properties of turn-inducing ferrocene scaffolds regulate the hydrogen bonding patterning of the derived peptides: the 10-membered interstrand hydrogen-bonded rings were established in the conjugates of the amino acids or peptides with dicarbonyl-functionalized ferrocene core [1,2], the 12-membered interstrand rings were formed in their conjugates with -NH-Fn-CO- moiety,[3] while conjugation with diamino-functionalized ferrocene lead to the 14-membered interstrand hydrogen-bonded rings which were also labelled as two simultaneous ten-membered rings [4,5].

Herein, we report the synthesis of the conjugate I composed of ferrocene-1,1'-diamine and valine. The influence of the turn-inducing ferrocene scaffold and the bulkiness of valine side chains on the conformational properties of the derived bioconjugate is explored by IR, NMR and CD spectroscopy, DFT study and crystallographic analysis. The spectroscopic data of the novel compound in solution, that suggest a presence of one 10-membered hydrogen-bonded ring also known as β -turn, are corroborated with DTF calculations.

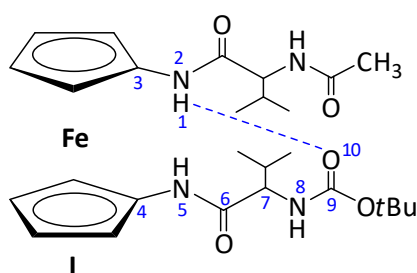

Figure 1: Conjugate of ferrocene-1,1'-diamine and valine.

References

- [1] T. Moriuchi and T. Hirao, *J. Incl. Phenom. Macrocycl. Chem.* **74** (2012) 23-40.
- [2] T. Moriuchi and T. Hirao, *Acc. Chem. Res.* **43** (2010) 1040-1051.
- [3] L. Barišić, M. Čakić, K. A. Mahmoud, Y. Liu, H.-B. Kraatz, H. Pritzkow, S. I. Kirin, N. Metzler Nolte and V. Rapić, *Chem. Eur. J.* **12** (2006) 4965-4980.
- [4] S. Chowdhury, K. A. Mahmoud, G. Schatte and H.-B. Kraatz, *Org. Biomol. Chem.* **3** (2005) 3018-3023.
- [5] M. Kovačević, I. Kodrin, M. Cetina, I. Kmetič, T. Murati, M. Čakić Semenčić, S. Roca and L. Barišić, *Dalton Trans.* **44** (2015) 16405-16420.

Synthesis and characterization of 1,2,3-triazole ligands and their transition metal complexes

Sinteza i karakterizacija 1,2,3-triazolnih liganada i njihovih kompleksa s prijelaznim metalima

Natalija Pantalon Juraj,¹ Tiana Novosel,² Marko Krklec,² Berislav Perić,¹ Robert Vianello,¹
Silvana Raić-Malić,² Srećko I. Kirin¹

¹Ruđer Bošković Institute, Zagreb, Croatia

²Faculty of Chemical Engineering and Technology, University of Zagreb, Croatia

E-mail: npantal@irb.hr

Click chemistry, an approach to synthesis using fast, versatile and high yielding reactions, has recently attracted attention as a simple way of preparing a wide scope of products. 1,2,3-triazoles can be prepared by Huisgen 1,3-cycloaddition of azides and alkynes, where copper (I) as the catalyst dictates the formation of a 1,4-disubstituted triazole ring [1]. The triazole group is a weak base and depending on the conditions it can act both as a donor or acceptor of protons, as well as a ligand for coordinating metals [2]. The large dipole moment of triazole molecules (5 D) allows easy formation of hydrogen bonds, as well as dipole-dipole and π interactions, which increase their solubility and allow binding to biological targets [3]. In this work, bis- and mono-1,2,3-triazole ligands and their metal complexes were prepared. Complexes of the thiazole ligand **4c** were fully characterized by NMR, UV/Vis and IR spectroscopy. (SMD)/M05-2X/6-31+G(d)/LanL2DZ + ECP calculations helped in interpreting relative stabilities of *mer*, *trans-fac* and *cis-fac* isomers of ML_2 complexes. The prepared ligands and complex **4c_{Zn}** will be tested for their antiproliferative properties.

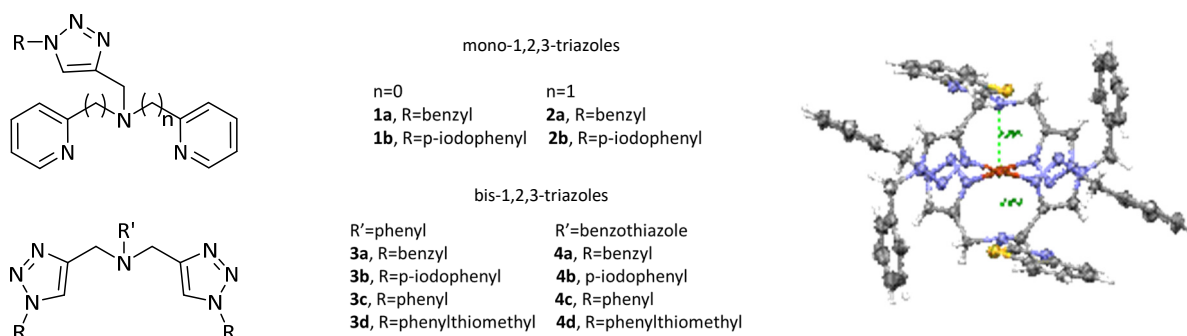

Figure 1: Synthesized mono- and bis-1,2,3-triazole derivatives (left) and crystal structure of complex **4c_{Cu}** (right).

References

- [1] V. D. Bock, H. Hiemstra and J. Maarseveen, *Eur. J. Org. Chem.* **1** (2006) 51-68.
- [2] J. T. Simmons, J. R. Allen, D. R. Morris, R. J. Clark, C. W. Levenson, M. W. Davidson and L. Zhu, *Inorg. Chem.* **52** (2013) 5838-5850.
- [3] S. Haider, M. S. Alam and H. Hamid, *Inflamm. Cell Signal.* **1** (2014) 95.

**1,3-Dipolar cycloaddition reaction of 5,10,15,20-tetra(3-pyridyl)porphyrin
with azomethine ylide**
**Reakcija 1,3-dipolarne cikloadicije 5,10,15,20-tetra(3-piridil)porfirina s
azometinskim ilidom**

Magdalena Vincetić, Nela Malatesti

Department of Biotechnology, University of Rijeka, Rijeka, Croatia

E-mail: nela.malatesti@biotech.uniri.hr

Synthetic and natural porphyrins have a great potential as photosensitisers in photodynamic therapy (PDT). However, for many PDT applications, the main drawback is their low absorption in the red part of the spectrum. Therefore, methods to convert porphyrins into chlorins and bacteriochlorins are constantly sought [1]. Some of these strategies include cycloaddition reactions since porphyrins may act as dienes and dienophiles in Diels-Alder reaction, and as 1,3-dipoles and dipolarophiles in 1,3-dipolar cycloaddition reactions [2]. Recently we reported the synthesis of a series of *N*-methylated and *N*-oxidised pyridylporphyrins and demonstrated high phototoxicity *in vitro* against various cancer cells with majority of the amphiphilic derivatives [3]. Before extending our research on tissues and *in vivo*, where the penetration of red light becomes more relevant, we wanted to investigate the reactivity of pyridylporphyrins in cycloaddition reactions. Silva *et al.* reported 1,3-dipolar cycloaddition reactions of *meso*-substituted porphyrins with azomethine ylides, describing higher reactivity of porphyrins with electron-withdrawing groups [4]. We employed a similar procedure on 5,10,15,20-tetra(3-pyridyl)porphyrin and 5-(4-acetamidophenyl)-10,15,20-tris(3-pyridyl)porphyrin. Azomethine ylide was generated *in situ* from sarcosine and either paraformaldehyde or benzaldehyde. Several different reaction conditions were applied, including microwave irradiation. In all cases, a very low reactivity was observed and mostly unreacted porphyrin was recovered. Monoadducts formed in all reactions, but could not be separated from other products of, presumably, multiple additions (bisadducts and trisadducts). Finally, a monoadduct from the reaction of 5,10,15,20-tetra(3-pyridyl)porphyrin and azomethine ylide, that was generated from sarcosine and paraformaldehyde, in toluene, was isolated after several purifications by column chromatography. The chlorin structure of the monoadduct was confirmed by ¹H, ¹³C NMR and UV/Vis spectroscopy. The product was also analysed by fluorescence spectroscopy. The synthesis, NMR, UV/Vis and fluorescence spectra of the cycloadduct will be presented and described in comparison to its parent compound.

References

- [1] J. M. Sutton, O. J. Clarke, N. Fernandez and R. W. Boyle, *Bioconjugate Chem.* **13** (2002) 249-263.
- [2] J. A. S. Cavaleiro, *Porphyrins in Diels-Alder and 1,3-dipolar cycloaddition reactions*, in *Progress in Heterocyclic Chemistry*, G. W. Gribble and J. A. Joule (Eds.), Elsevier, 2008, Oxford; p. 44-69.
- [3] M. Jelovica, P. Grbčić, M. Mušković, M. Sedić, S. Kraljević Pavelić, M. Lončarić and N. Malatesti, *ChemMedChem* **13** (2018) 360-372.
- [4] A. M. G. Silva, A. C. Tomé, M. G. P. M. S. Neves, A. M. S. Silva and J. A. S. Cavaleiro, *J. Org. Chem.* **70** (2005) 2306-2314.

Synthesis and photochemical properties of an anion receptor containing azocarboxamide groups

Sinteza i fotokemijska svojstva anionskog receptora s azokarboksamidnim skupinama

Nikola Cindro,¹ Dajana Barišić,² Nikola Bregović,¹ Krunoslav Užarević,² Vladislav Tomišić²

¹Department of Chemistry, Faculty of Science, University of Zagreb, Zagreb

²Laboratory for Green Synthesis, Ruđer Bošković Institute, Zagreb

E-mail: ncindro@chem.pmf.hr

Many anion receptors have been developed for selective recognition and binding of a specific negatively charged species. Their structure usually contains covalently linked groups with high affinity towards the desired ions [1]. The binding ability of the receptor for an anion in specific solvent once defined by its structure usually cannot be changed using external stimuli. In recent years there have been a few examples of responsive receptors which utilize groups capable of changing the affinity towards an anion in the presence of external stimuli [2]. They are comprised of photochromic moieties which have been till recently almost exclusively studied with larger guests [3]. That is in part because it is easier to prepare receptors in which photoresponsive change in the architecture controls binding of larger species as compared to small anions.

Herein we present an anionic receptor with photoresponsive host-guest properties designed for small anions. Basic motion is achieved through *E-Z* isomerization of azocarboxamide. The simplest aromatic derivative containing azocarboxamide as well as photochemical isomerization is shown below.

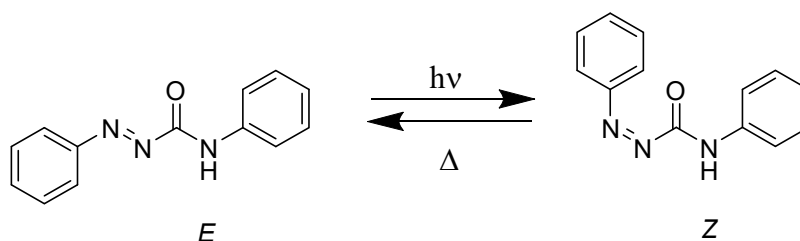

Figure 1: Photoisomerization of an aromatic azocarboxamide.

References

- [1] D. Barišić, N. Cindro, M. Juribašić Kulcsár, M. Tireli, K. Užarević, N. Bregović and V. Tomišić, *Chem. Eur. J.*, accepted for publication.
- [2] Z. Kokan and M. J. Chmielewski, *J. Am. Chem. Soc.* **140** (2018) 16010-16014.
- [3] D-H. Qu, Q-C. Wang, Q-W. Zhang, X. Ma and H. Tian, *Chem Rev.* **115** (2015) 7543-7588.

Adsorption of polyacrylic acid onto aluminum oxide and silicon carbide Adsorpcija poli(akrilne kiseline) na aluminijevu oksidu i silicijevu karbidu

Nikolina Filipović, Jelena Brdarić, Berislav Marković, Natalija Šantić, Dalibor Tatar
Odjel za kemiju Sveučilišta u Osijeku, Osijek, Hrvatska

E-pošta: nfilipovic@kemija.unios.hr

Adsorpcija polimera na površinama minerala od velikog je značaja u mnogim industrijskim granama i primjenama. Fizikalno-kemijska svojstva polimera, supstrata te općenito suspenzija određuju adsorpciju na granici faza čvrsto/tekuće. Upravo o svojstvima i strukturama polimera ovisi kinetika i ravnoteža adsorpcijskih procesa. U radu je ispitana adsorpcija poli(akrilne) kiseline različitih molekulskih masa na aluminijevu oksidu i silicijevu karbidu pri različitim pH-vrijednostima (Slika 1). Uzorci aluminijeva oksida imali su jednak mineraloški sastav, ali različit porozitet. Čvrste, porozne nakupine sastavljene od finih kristalita karakterizirane su primjenom rasterskog elektronskog mikroskopa (SEM), a poroznost čestica određena je adsorpcijom dušika (B.E.T.) i živinom porozimetrijom. Molekularne dimenzije poli(akrilne) kiseline izračunate su pri njezinim različitim konformacijama u zavisnosti od pH: zavijenoj (*coiled*) i ispruženoj (*stretched*). Ustanovljeno je da adsorpcijska gustoća raste na neporoznoj površini, te da se značajno smanjuje pri porastu molekulske mase kada je površina čestica porozna (kod pH manjeg od 7). U suspenzijama koje su kisele, poli(akrilna) kiselina u najvećoj mjeri nije ionizirana te tada dostupna površina za adsorpciju ovisi o veličini molekula polimera. Ispitivanja su pokazala da prilikom adsorpcije poliakrilne kiseline na pločicama silicijeva karbida dolazi do promjene ζ -potencijala. Poznato je da su aluminijev oksid i silicijev karbid uobičajeni keramički materijali te bi rezultati ovoga rada mogli doprinijeti razvoju drugačijih tehnika proizvodnje različitih keramičkih materijala baziranih na osnovama koloidne kemije [1].

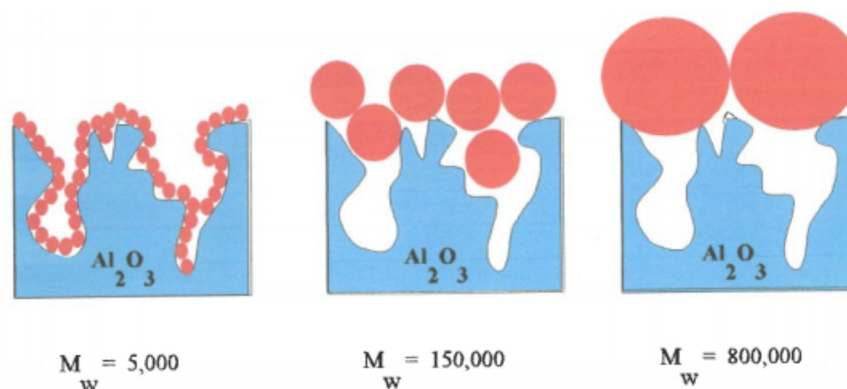

Slika 1: Shematski model adsorpcije poliakrilne kiseline na poroznom aluminijevu oksidu (pH < 7).

Reference

[1] A. A. Zaman, R. Tsuchiya and B. M. Moudgil, *J. Colloid Interface Sci.* **256** (2002) 73-78.

Biocatalysis, circular economy and cosmetics: the BIOCOSM project Biokataliza, cirkularna ekonomija i kozmetika: BIOCOSM projekt

Nikolina Vidovic,¹ Kalliopi Avramidou,¹ Ermelinda Falletta,¹ Teresa Recca,¹ Giorgio Marrubini,² Riccardo Semproli,^{2,3} Diego Bosco,^{3,4} Filippo Fiorentini,⁴ Silvia Rapacioli,⁴ Daniela Ubiali,^{2,3} Giovanna Speranza¹

¹Department of Chemistry, University of Milan, Milan, Italy

²Department of Drug Sciences, University of Pavia, Pavia, Italy

³Consorzio Italbiotec, Milano, Italy

⁴Bict srl, Lodi, Italy

E-mail: nikolina.vidovic@unimi.it

It is estimated that most cosmetic products have a lifespan of less than five years and manufacturers reformulate 25% of their products every year. Thus, cosmetic products need to be constantly improved in order to stay ahead in a highly competitive market where wider choice and ever greater efficacy are expected by the consumer. The increasing demand for innovation, “green” chemical processes and “natural” products is driving R&D to explore new technologies and new feedstocks [1].

Upgrading of agro-food residues by enzyme-aided processes (*i.e.* biocatalysis) to obtain high-added value products is a clear example of biorefinery where waste is managed sustainably by turning it into a resource, thus fulfilling the requirements of “circular economy” [2]. Starting from the know-how developed over the years in the valorization of protein-rich feedstocks such as hemp [3], flax [4], and rice [5], one of the goals of the BIOCOSM project is to exploit the waste derived from soybean and sunflower seeds for the production of protein hydrolysates (HVP, Hydrolyzed Vegetable Proteins) to be used as ingredients in cosmetics. The experience of the BIOCOSM team in biocatalysis, enzyme immobilization, organic and analytical chemistry, chemometrics and project management, strengthened by a unique synergy derived from an industrial-academic partnership, is expected to give a significant boost to fill the gap that still hampers a wider use of biocatalytic methods for industrial applications. The final goals of the project are:

- developing innovative bio-products and bio-processes specifically designed for the cosmetic market through an integrated and multidisciplinary approach;
- building up a self-sustainable productive chain of cosmetic ingredients (from bench to market);
- training young researchers in a vibrant scientific environment.

References

- [1] M. B. Anson-Schumacher and O. Thum, *Chem. Soc. Rev.* **42** (2013) 6475-6490.
[2] A. Pellis, S. Cantone, C. Ebert and L. Gardossi, *New Biotechnol.* **40** (2018) 154-169.
[3] L. P. Orio, G. Boschini, T. Recca, C. F. Morelli, L. Ragona, P. Francescato, A. Arnoldi and G. Speranza, *J. Agric. Food Chem.* **65** (2017) 10482-10488.
[4] T. Kaewmanee, L. Bagnasco, M. Benjakul, S. Lanteri, C. Morelli, G. Speranza and M. E. Cosulich, *Food Chem.* **148** (2014) 60-69.
[5] L. Bagnasco, V. M. Pappalardo, A. Meregaglia, T. Kaewmanee, D. Ubiali, G. Speranza and M. E. Cosulich, *Food Res. Int.* **50** (2013) 420-427.

Acknowledgment: This project (2017-0978) was funded by Cariplo Foundation (Italy).

Complexation of lanthanides by aroylhydrazones derived from nicotinic acid hydrazide: mass spectrometric determination Kompleksiranje lantanoida aroilhidrazonima izvedenim iz nikotinohidrazida: određivanje spektrometrijom masa

Nives Galić,¹ Marijana Pocrnić,¹ Darko Kontrec²

¹Kemijski odsjek, Prirodoslovno-matematički fakultet, Sveučilište u Zagrebu, Zagreb, Hrvatska

²Zavod za organsku kemiju i biokemiju, Institut Ruđera Boškovića, Zagreb, Hrvatska

E-pošta: ngalic@chem.pmf.hr

Aromatski hidrazoni izvedeni iz nikotinohidrazida i različito supstituiranih aldehida dobro vežu ione metala, uključujući katione lantanoida. Spektrofotometrijskim titracijama određene su konstante vezanja aromatskih hidrazona (Slika 1) i odabranih kationa lantanoida (lantana, europija, gadolinija i iterbija), a metodom kontinuirane varijacije sastavi kompleksnih spojeva [1,2]. Utvrđeno je da stabilni kompleksi trenutačno nastaju s derivatima *N'*-saliciliden-3-piridinkarbohidrazidom (**1**) i *N'*-(2-hidroksi-4-metoksifenilmetiliden)-3-piridin-karbohidrazidom (**3**). ApSORPCIJSKI spektar kompleksa s *N'*-(2-hidroksi-3-metoksifenil-metiliden)-3-piridinkarbohidrazidom (**2**) mijenjao se tijekom vremena te je pretpostavljeno da kompleks koji prvobitno nastaje podliježe dodatnoj ravnoteži.

Kako bi se dobio detaljniji uvid u vezanje lantanoida aromatskim hidrazonima, u ovom radu nastajanje kompleksnih spojeva praćeno je tehnikom spektrometrije masa. Spektri masa otopina lantanoida i aromatskih hidrazona sastava 1:1 snimljeni su uz ionizaciju elektroraspršenjem u pozitivnom načinu rada (ESI+ MS) neposredno po pripremi otopina. S obzirom na to da je za komplekse lantanoida sa spojem **2** uočena promjena u UV-Vis spektrima tijekom vremena, spektri masa otopine europija(III) i 3-metoksi derivata snimljeni su i nakon 5 dana. Istražen je utjecaj otapala na intenzitete signala kompleksnih iona u spektru masa te su kao otapala korišteni acetonitril i smjesa metanola i vode omjera 1:1. Za sve navedene sustave provedena je i analiza tandemnom spektrometrijom masa. Na temelju MS/MS spektara iona kompleksa predložene su odgovarajuće sheme fragmentiranja i uspoređene s fragmentiranjem samih liganada [3].

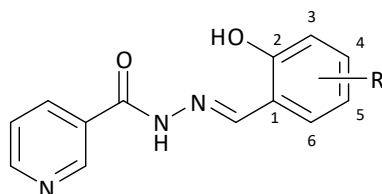

Slika 1: Struktura aromatskih hidrazona: R = H (**1**); 3-OCH₃ (**2**); 4-OCH₃ (**3**).

Reference

- [1] F. Grgić, H. Rimanić, M. Pocrnić, D. Kontrec, A. Budimir i N. Galić, 26 HSKIKI, Knjiga sažetaka.
- [2] M. Pocrnić, D. Kontrec, A. Budimir i N. Galić, 18th International Symposium and Summer School on Bioanalysis, Book of Abstracts, p.67., Komarno, Slovakia, 2018.
- [3] D. Stražić, T. Benković, D. Gembarovski, D. Kontrec i N. Galić, *Int. J. Mass Spectrom.* **371** (2014) 54-64.

Napomena: Istraživanje je financirano od strane Hrvatske zaklade za znanost (projekt IP-2014-09-4841).

The use of solid-state NMR spectroscopy in organic and metal-organic systems

Uporaba nuklearne magnetske rezonancije u karakterizaciji organskih i metal-organskih sustava

Robin S. Stein,¹ Catherine King,¹ Igor Huskić,¹ Julia L. Shamshina,¹ Hatem Titi,¹ Tomislav Friščić,¹ Robin D. Rogers²

¹McGill University Department of Chemistry, Montreal, Quebec Canada

²525 Solutions, Inc., Tuscaloosa, Alabama, USA

E-mail: robin.stein@mcgill.ca

Cross-polarization magic-angle spinning (CPMAS) experiments are very widely used techniques to characterize solid materials with NMR. The technique transfers magnetization from one nucleus (usually an abundant, high-gamma nucleus such as ¹H) to a less abundant isotope such as ¹³C or ¹⁵N. However, the technique is usually not quantitative, as the efficiency of polarization transfer and relaxation times are site-dependent. The multiCP technique of Johnson and Schmidt-Rohr [1] overcomes this problem by using a total contact time long enough to evenly distribute signal among all sites, while protecting the probe by inserting short delay times between contact periods. We apply it to the problem of measuring chitin content in shrimp shells treated with ionic liquid [2]. This avoids traditional chitin characterization techniques that require the use of harsh chemicals. Another limitation of CP is that the bandwidth is often limited, so broad patterns are unevenly excited and thus distorted. The BRAINCP-WCPMG technique of Schurko et al. [3] uses broadband WURST pulses to excite wide powder patterns. We use the technique applied to static ¹¹³Cd SSNMR to study cadmium-containing metal-organic frameworks. The very different cadmium environments in various MOFs and in pure cadmium acetate are reflected in their distinct CSA patterns.

References

- [1] R. L. Johnson and K. J. Schmidt-Rohr, *J. Magn. Reson.* **239** (2014) 44-49.
- [2] C. King, R. S. Stein, J. L. Shamshina and R. D. Rogers, *ACS Sust. Chem. Eng.* **5** (2017) 8011-8016.
- [3] K. J. Harris, A. Lupulescu, B. E. G. Lucier, L. Frydman and R. W. Schurko *J. Magn. Reson.* **224** (2012) 38-47.

Influence of chain length on the nucleofugality of aliphatic carboxylates Utjecaj duljine lanca na nukleofugalnost alifatskih karboksilata

Sandra Jurić, Marijan Marijan, Olga Kronja

University of Zagreb, Faculty of Pharmacy and Biochemistry, Zagreb, Croatia

E-mail: sjuric@pharma.hr

Nucleofugalities (the leaving group abilities) of aliphatic carboxylates in various solvents have been derived from the S_N1 solvolysis rate constants of the corresponding ferrocenyl-X-phenylmethyl derivatives **1-4** (Scheme 1) by applying the linear free energy relationship (LFER) equation: $\log k = s_f (E_f + N_f)$ [1]. In this equation k is a first order rate constant for S_N1 reaction at 25 °C, s_f (slope of the $\log k/E_f$ correlation line) and N_f (nucleofugality, negative intercept on the abscissa of the $\log k/E_f$ correlation line) are nucleofuge specific parameters, while E_f is the electrofugality parameter of the corresponding ferrocenylphenylmethyl cations determined earlier [2]. This method makes feasible estimating the solvolytic reactivity in a given solvent of any substrate constituted from an electrofuge of known E_f parameter and a nucleofuge of known s_f and N_f parameters.

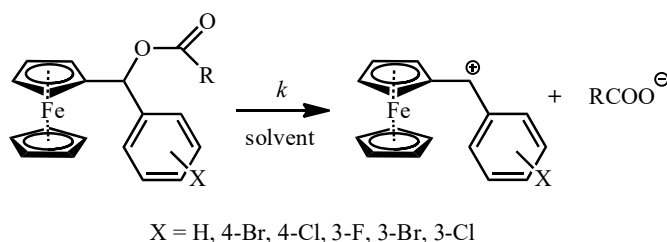

- 1 Butyrate, R = CH₃CH₂CH₂
- 2 Isobutyrate, R = (CH₃)₂CH
- 3 Valerate, R = CH₃CH₂CH₂CH₂
- 4 Isovalerate, R = (CH₃)₂CHCH₂

Scheme 1: Solvolysis of ferrocenyl-X-phenylmethyl butyrates (1), isobutyrate (2), valerates (3), and isovalerates (4).

Aliphatic carboxylates represent relatively poor leaving groups, whose nucleofugalities are similar to the nucleofugalities of pyridine and its 4-substituted derivatives [3]. The N_f values for butyrate in all examined solvents are slightly higher than N_f values for valerate, indicating that the introduction of one $-CH_2-$ group into the carboxylate moiety leads to a small decrease of the solvolytic reactivity of valerate, probably due to a small steric effect. On the other hand, with branched analogues the effect of solvent is more pronounced so that ferrocenyl-X-phenylmethyl isovalerates solvolyze faster than the corresponding isobutyrate.

References

- [1] (a) N. Streidl, B. Denegri, O. Kronja and H. Mayr, *Acc. Chem. Res.* **43** (2010) 1537-1549. (b) B. Denegri, A. Streiter, S. Jurić, A. R. Ofial, O. Kronja and H. Mayr, *Chem. Eur. J.* **12** (2006) 1648-1656. (c) B. Denegri, A. R. Ofial, S. Jurić, A. Streiter, O. Kronja and H. Mayr, **12** (2006) 1657-1666.
- [2] M. Marijan, S. Jurić, Z. Mihalić and O. Kronja, *Eur. J. Org. Chem.* (2019) 537-546.
- [3] (a) M. Matić, B. Denegri, S. Jurić and O. Kronja, *Croat. Chem. Acta* **90** (2017) 571-581. (b) S. Jurić, T. Portolan and O. Kronja, *Croat. Chem. Acta* **89** (2016) 65-70. (c) S. Jurić and O. Kronja, *J. Phys. Org. Chem.* **28** (2015) 314-319.

Proton transport across inner mitochondrial membrane assisted with UCP2 protein

Prijenos protona kroz unutarnju mitohondrijsku membranu pomoću UCP2 proteina

Sanja Škulj, Zlatko Brkljača, Mario Vazdar

Division of Organic Chemistry and Biochemistry, Ruđer Bošković Institute, Zagreb, Croatia

E-mail: sanja.skulj@irb.hr

Proton transport across mitochondrial cell membranes is one of the main metabolic processes in living organism. This transfer from mitochondrial intermembrane space to the mitochondrial matrix across the inner mitochondrial membrane is caused by the existence of the transmembrane proton gradient [1]. It is known that long chain fatty acids (LCFA) together with the uncoupling proteins (UCP) participate in the regulation of the transmembrane proton gradient, where UCP catalyzes proton transfer across the inner mitochondrial membrane [2].

The mechanism *via* which UCP protein and FA work together is still unknown and the insight into it will help to better understand the function of mitochondria and cell bioenergetics [3]. First, we considered neutral and deprotonated LCFA forms of different length and calculated free energy profiles inside the neat DOPC bilayer using molecular dynamics (MD) simulations. We found that the free energy barriers for the translocation (flip-flop) of neutral and deprotonated forms of fatty acids are approximately 3 kcal mol⁻¹ and 16 kcal mol⁻¹, respectively. This finding implies that very fast flip-flop of neutral fatty acids across bilayers readily occurs while transport of deprotonated fatty acid is slow and does not occur at the biologically relevant timescale. In order to understand how UCP assists the transport of deprotonated form of LCFA, we simulated mitochondrial uncoupling protein 2 (UCP2) in the DOPC bilayer using advanced MD simulations. The electrostatic potential maps of UCP2 protein indicate the existence of a positively charged surface which could lower free energy barrier for translocation of deprotonated LCFA. Our results are in agreement with cycling protonophoretic mechanism [2], shedding additional light on this principal biophysical process in mitochondria.

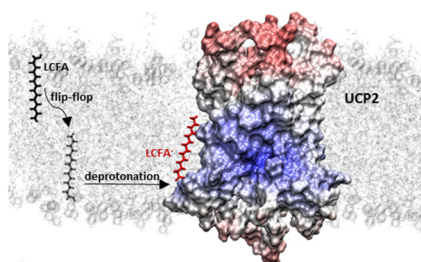

Figure 1: Schematic representation of proton transport assisted with UCP2 protein.

References

- [1] J. M. Berg, J. L. Tymoczko, L. Stryer, *Biochemistry*, W. H. Freeman, New York, 2002, 491-526.
- [2] K. D. Garlid, D. E. Orosz, M. Modrianský, S. Vassanelli and P. Jezek, *J. Biol. Chem.* **271** (1996) 2615-2620.
- [3] M. J. Berardi and J. J. Chou, *Cell Metab.* **20** (2014) 541-552.

Characterization of DPP III interactions with Keap1 Kelch domain Karakterizacija interakcija DPP III s domenom Kelch proteina Keap1

Sara Matić,¹ Mihaela Matovina,¹ Filip Šupljika,² Ivo Crnolatac,¹ Sanja Tomić¹

¹Ruđer Bošković Institute, Zagreb, Croatia

²Faculty of Food Technology and Biotechnology, University of Zagreb, Zagreb, Croatia

E-mail: sara.matic@irb.hr

Dipeptidyl peptidase III (DPP III) is a zinc metallo-exopeptidase from the M49 family. The physiological role of DPP III, as well as its in vivo substrates, are still not fully elucidated. At the same time, experimental evidence of the involvement of DPP III in the development of some types of cancer in humans is increasing, and the potential involvement of DPP III in carcinogenesis might be associated with a role of DPP III in the Keap1-Nrf2 signaling pathway [1-3]. Keap1 acts as a cytosolic repressor of Nrf2 transcription factor. Under conditions of oxidative stress, Nrf2 is released from Keap1 and translocated to the nucleus, where it initiates the expression of a large number of genes with antioxidative and cytoprotective functions [4]. DPP III is involved in the Keap1-Nrf2 signaling pathway due to competitive binding to the Keap1 Kelch domain through the DPP III loop which contains an ETGE motif, that corresponds to the high affinity Keap1-binding motif of Nrf2. Binding of DPP III to Keap1 releases Nrf2 from the complex with Keap1 and increases the amount of Nrf2 in the cell, leading to the enhanced expression of the Nrf2 target genes, that have been found to promote the resistance to chemotherapeutic drugs in cancer cells [2]. In the attempt to clarify the role of DPP III in carcinogenesis, our aim is to further characterize the interaction of DPP III with the Kelch domain. For this purpose we use computational methods such as molecular dynamics simulations, as well as experimental methods including isothermal titration calorimetry (ITC), microscale thermophoresis (MST) and circular dichroism (CD). Understanding the DPP III – Keap1 interaction at the molecular level and determining thermodynamic parameters of the interaction would enable further studies of the factors influencing this interaction, and give additional insight into its role in the oxidative stress response and resistance to the chemotherapeutic drugs.

References

- [1] B. E. Hast, D. Goldfarb, K. M. Mulvaney, M. A. Hast, P. F. Siesser, F. Yan, D. N. Hayes and M. B. Major, *Cancer Res.* **73** (2013) 2199-2210.
- [2] M. C. Jaramillo and D. D. Zhang, *Genes Dev.* **27** (2013) 2189-2191.
- [3] K. Lu, A. L. Alcivar, J. Ma, T. K. Foo, S. Zywea and A. Mahdi, *Cancer Res.* **77** (2017) 2881-2892.
- [4] T. Nguyen, P. Nioi and C. B. Pickett, *J. Biol. Chem.* **284** (2009) 13291-13295.

Conformation and self-assembling of quinoline–ferrocene conjugates Konformacija i samoudruživanje konjugata kinolina i ferocena

Mario Cetina,¹ Silvija Maračić,² Jasmina Lapić,³ Senka Djaković,³ Silvana Raić-Malić²

¹University of Zagreb, Faculty of Textile Technology, Department of Applied Chemistry
Zagreb, Croatia

²University of Zagreb, Faculty of Chemical Engineering and Technology, Department of Organic
Chemistry, Zagreb, Croatia

³University of Zagreb, Faculty of Food Technology and Biotechnology, Laboratory for Organic
Chemistry, Zagreb, Croatia

E-mail: mario.cetina@ttf.hr

Tremendous progress in the incorporation of organometallic fragments into biomolecules to provide compounds with anticancer activity has been observed in recent years. Among bioactive organometallic compounds, iron-containing metallocenes, ferrocenes conjugated with biologically active compounds, have been found to exhibit promising cytostatic effects [1]. Furthermore, ferrocifen compounds were developed as ferrocenyl analogs of tamoxifen, a known antagonist of estrogen receptor in breast cancer. Compared with tamoxifen, ferrocifens possessed not only endocrine-modulating properties, but also cytotoxic effects against estrogen-independent breast cancer. On the other hand, quinoline and quinolone scaffolds play an important role in anticancer drug development as their derivatives have shown activity through diverse mechanisms of action, such as growth inhibition by cell cycle arrest, apoptosis, abrogation of cell migration, inhibition of angiogenesis and dysregulation of nuclear receptor signalling [2]. Recently, we have described the synthesis of novel ferrocene–quinoline and quinolone conjugates, and evaluated their cytostatic and antioxidant activities [3]. The 6-chloro-4-[2-(4-ferrocenyl-1,2,3-triazol-1-yl)ethoxy]-2-(trifluoromethyl) quinoline (**1**), with selective inhibitory activity on Raji cells ($IC_{50} = 7.9 \mu M$) and no cytostatic effect on normal MDCK1 cells, was highlighted as the most promising anticancer organometallic complex in a group of *O*-alkylated quinolines. In this work we report structures of two ferrocene–quinoline conjugates, 6-chloroquinoline-ferrocene conjugate **1** and 4-[2-(4-ferrocenyl-1,2,3-triazol-1-yl)ethoxy]-2-(trifluoromethyl) quinoline (**2**), with focus on self-assembly of the molecules (Figure 1) and their conformation.

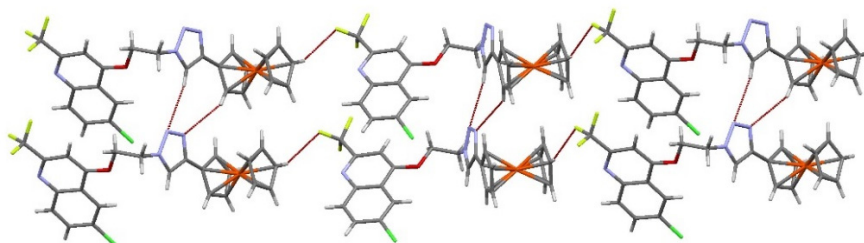

Figure 1: A part of the crystal structure of **1**, showing self-assembling of the molecules.

References

- [1] K. Kowalski, *Coord. Chem. Rev.* **366** (2018) 91-108.
- [2] O. Afzal, S. Kumar, M. R. Haider, M. R. Ali, R. Kumar, M. Jaggi and S. Bawa, *Eur. J. Med. Chem.* **97** (2015) 871-910.
- [3] S. Maračić, J. Lapić, S. Djaković, T. Opačak-Bernardi, Lj. Glavaš-Obrovac, V. Vrček and S. Raić-Malić, *Appl. Organometal. Chem.* **33** (2019) e4628.

Novel symmetric bis-benzimidazoles: synthesis, DNA/RNA binding and antitrypanosomal activity

Novi simetrični bis-benzimidazoli: sinteza, DNA/RNA vezivanje i antitripanosomska aktivnost

Andrea Bistrović,¹ Ivana Stolić,² Luka Krstulović,² Martin C. Taylor,³ John M. Kelly,³
Sanja Tomić,⁴ Miroslav Bajić,² Silvana Raić-Malić¹

¹Faculty of Chemical Engineering and Technology, University of Zagreb, Zagreb, Croatia

²Faculty of Veterinary Medicine, University of Zagreb, Zagreb, Croatia

³London School of Hygiene and Tropical Medicine, London, UK

⁴Ruđer Bošković Institute, Zagreb, Croatia

E-mail: sraic@fkit.hr

Human African trypanosomiasis (HAT), or sleeping sickness, is one of the most deadly neglected tropical diseases (NTDs), with 65 million people at risk in 36 countries [1]. Current therapies for HAT are unsatisfactory and under threat from emerging resistance [2]. In continuation of our recent work on the development of aromatic amidines as DNA-binding ligands and anti-trypanosomal agents [3], we aimed here to expand the benzimidazole scaffold to 5-membered furyl and 1,2,3-triazolyl moieties that may adopt helical topology to approximately match the curvature of DNA in the minor groove.

The novel benzimidazol-2-yl-fur-5-yl-(1,2,3)-triazolyl dimeric series with aliphatic and aromatic central linkers was successfully prepared with the aim of assessing binding affinity to DNA/RNA and antitrypanosomal activity. The bis-benzimidazole imidazoline **15c**, with antitrypanosomal potency in the submicromolar range and DNA interacting properties, emerged as a candidate for further structural optimization to obtain more effective agents to combat trypanosome infections.

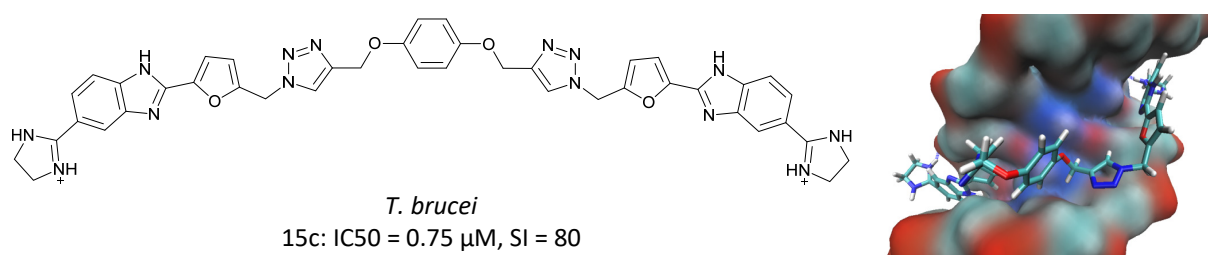

Figure 1: Molecular structure of new bis-benzimidazole imidazoline 15c with antitrypanosomal potency.

References

- [1] M. Njoroge, N. M. Njuguna, P. Mutai, D. S. Ongarora, P. W. Smith and K. Chibale, *Chem. Rev.* **114** (2014) 11138-11163.
- [2] C. P. Ward, P. E. Wong, R. J. Burchmore, H. P. de Koning and M. P. Barrett, *Antimicrob. Agents Chemother.* **55** (2011) 2352-2361.
- [3] A. Bistrović, L. Krstulović, I. Stolić, D. Drenjančević, J. Talapko, J. M. Kelly, M. Bajić and S. Raić-Malić, *J. Enzyme Inhib. Med. Chem.* **33** (2018) 271-285.

Benzimidazole-1,2,3-triazole derivatives and bis-(1,2,3-triazolyl-benzimidazolyl)benzenes: synthesis and chemosensing properties

1,2,3-triazoli-benzimidazoli i bis-(1,2,3-triazolil-benzimidazolil)benzeni: sinteza i optička senzorska svojstva

Kristina Bobanović, Ivana Steinberg, Svjetlana Krištafor

Department of General and Inorganic Chemistry, Faculty of Chemical Engineering and Technology, Zagreb, Croatia

E-mail: prekupec@fkit.hr

Nitrogen-containing heterocycles are widely investigated structures in the field of biology, medicine and chemical sensors. Benzimidazole and its derivatives are one of the most important building blocks in the design of novel biologically active molecules due to their structural similarity with naturally occurring nucleotides. In addition, combination of π -bridging and electron accepting properties of benzimidazole unit together with its metal-ion chelating ability and pH sensitivity, validated benzimidazole derivatives as promising candidates in fluorescent cellular imaging and metal ion sensing. Introduction of different electron donating and/or electron withdrawing substituents in the benzimidazole core can significantly affect the optical characteristics of the resulting molecule [1]. *Click*-derived triazoles play important roles in sensing mechanisms because of their π -conjugated character and coordinating ability. 1,2,3-triazole ring can act as a covalent linkage between benzimidazole and corresponding functional group or can directly participate in binding of the target analyte [2]. In this work we present the synthesis of novel benzimidazole-1,2,3-triazole conjugates and 1,3- and 1,4-bis(1,2,3-triazolyl-benzimidazolyl)benzenes as novel donor- π -acceptor systems using *click*-chemistry approach. The influence of aryl-substituted 1,2,3-triazole unit at position 2 of benzimidazole is studied. All compounds are examined as potential chemosensor molecules for pH and/or different metal cations using UV-Vis absorption and fluorescence spectroscopy. Detailed spectroscopic titrations in solutions are performed and fluorescence intensity changes are discussed as continuation of our ongoing research [3].

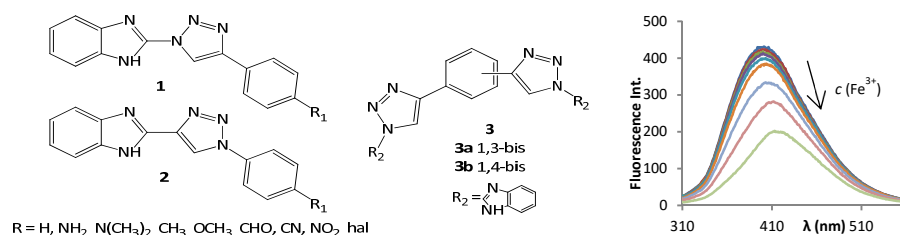

Figure 1: a) 1,2,3-triazolyl-benzimidazoles **1-2** and bis(triazolyl-benzimidazolyl)benzenes **3**;
b) Emission properties of **3a** upon titration with Fe³⁺ ions.

References

- [1] E. Horak, P. Kassal and I. Murković Steinberg, *Supramol. Chem.* **30** (2018) 838-857.
- [2] M. Juriček, P. H. J. Kouwer and A. E. Rowan, *Chem. Commun.* **47** (2011) 8740-8749.
- [3] M. Hranjec, E. Horak, D. Babić, S. Plavljanin, Z. Srdović, I. Murković Steinberg, R. Vianello and N. Perin, *New. J. Chem.* **41** (2017) 358-371.

Acknowledgment: This work was funded by the Croatian Science Foundation (HRZZ-3386, iNFiNiTE-SENS).

Volatile compounds in quinces-brandy (*Cydonia oblonga* Mill.) Hlapljivi spojevi u rakiji od dunje (*Cydonia oblonga* Mill.)

Zvonimir Marijanović,¹ Ivana Kulušić,² Marko Šuste,² Mladenka Šarolić,²
Žana Delić,² Tomislav Svalina²

¹Faculty of Chemistry & Technology, University of Split, Split, Croatia

²Marko Marulić Polytechnic of Knin, Knin, Croatia

E-mail: tsvalina@veleknin.hr

Quince fruit and its products (jam, marmalade, compote, juice, quince-brandy) are highly appreciated in the market [1]. Quince-brandy, as a distillate of fermented quince fruit, apart from the main elements, ethanol and water, contains other numerous ingredients. Their concentration varies within an average of 0.5 – 1.0% depending on the raw material content, the way in which alcohol fermentation is carried out, and the manner in which distillation is conducted [2]. Most fruit brandy is a traditional product from eastern Croatia (Slavonija and Baranja). In this research, the headspace volatiles of quince-brandy were isolated by headspace solid phase micro extraction (HS-SPME) using a fibre coated with the layer of polydimethylsiloxane/divinylbenzene (PDMS/DVB). Also, the liquid-liquid extraction was used with solvent mixture, pentane:diethyl ether (1:2 v/v). Obtained samples were analysed by gas chromatography-mass spectrometry (GC-MS) using HP-5MS column. Using HS-SPME we identified 11 compounds, while using liquid-liquid extraction of volatile compounds we identified 17 compounds. The most common compounds of the detected HS-SPME method were: *trans*-hex-2-enal (22.7%), isoamyl alcohol (16.2%) and hexyl acetate (13.9%). Liquid-liquid extraction showed: 1-hexanol (38.9%), 2-phenylethanol (18.9%), diethyl succinate (9.0%) and (*Z*)-octadec-9-en-1-ol (6.5%). Esters are very important constituents of brandy aroma, making positive contribution to the general quality of brandy providing delicate “fruity and floral” aromas, effecting the sensory properties and aromatic finesse of the brandy [3].

References

- [1] D. T. Veličković, M. S. Ristić, N. P. Milosavljević, D. N. Davidović, D. M. Milenović, A. S. Veličković, *Biologica Nyssana* **7** (2016) 145-149.
- [2] V. Tešević, N. Nikičević, A. Jovanović, D. Djoković, L. Vujisić, I. Vučković, M. Bonić, *Food Technol. Biotechnol.* **43** (2005) 367-372.
- [3] V. I. Petropoulos, E. Bogeve, T. Stafilov, M. Stefova, B. Siegmund, N. Pabi, E. Lankmayr, *Food Chem.* **165** (2014) 506-514.

New fumaramide gelators and their transcription in polymers Novi fumaramidni gelatori i njihov prijepis u polimere

Tomislav Gregorić, Janja Makarević, Leo Frkanec

Laboratory for Supramolecular Chemistry, Ruđer Bošković Institute, Zagreb, Croatia

E-mail: Tomislav.Gregoric@irb.hr

A major challenge in supramolecular chemistry is the synthesis of new materials that have improved properties for various uses in medical science, development of new biomaterials, sensors and many others [1]. Supramolecular chemistry has found interest in the synthesis of new materials because it provides a wide range of possibilities for generating new materials as self-organized nanomaterials using non-covalent interactions such as hydrogen bonds, π - π stacking or Van der Waals forces. We have investigated the synthesis of new polymers [2]. For this purpose have developed new amino acid vinyl fumaric acid derivatives such as mono and di (vinyl-amino acid) fumaramide. The novel supramolecular low molecular weight gelators are obtained (Figure 1). These compounds are capable of forming gels with various organic solvents. We investigated the possibility of polymerization in self-assembled gels induced by UV rays and gamma rays. The polymerization occurred in various gels. We have shown that small changes in the structure of compounds cause specific self-organization through non-covalent interactions which effects on the reactivity of crosslinked molecules. The resulting self-assemblies in different solvents are characterized by ^1H , ^{13}C , temperature dependent NMR and FTIR spectroscopy. Morphology of gel network and polymers are determined by TEM, SEM and AFM microscopy.

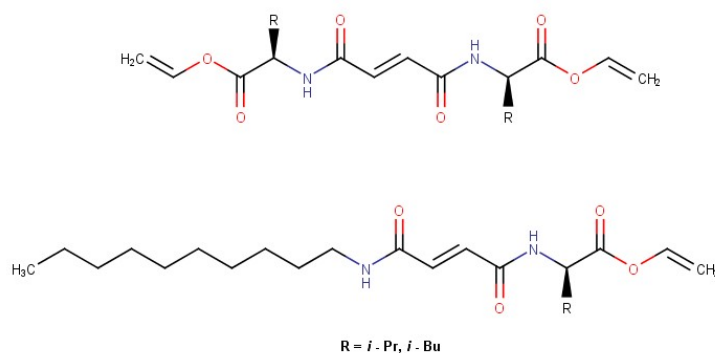

Figure 1: New fumaramide gelators.

References

- [1] E. Busseron, Y. Ruff, E. Moulin and N. Giuseppone, *Nanoscale*, **5** (2013) 7098.
- [2] D. J. Cornwell and D. K. Smith, *Mater. Horiz.* **2** (2015) 279.

The importance of diluent choice for sample solution stability: The DMSO case study

Važnost odabira prikladnog otapala za stabilnost otopine uzorka na primjeru DMSO-a

Valentina Petruševska,¹ Sandro Makarić,¹ Gordan Dinter,² Ana Mornar³

¹PLIVA Hrvatska d.o.o., Zagreb, Hrvatska

²Labtim Adria, d.o.o., Zagreb, Hrvatska

³Farmaceutsko-biokemijski fakultet, Sveučilište u Zagrebu, Zagreb, Hrvatska

E-pošta: valentina.petrusevska@pliva.com

Najčešće primjenjivane analitičke tehnike zahtijevaju otapanje krutog uzorka kako bi ga se moglo analizirati. Izbor otapala ovisi o analitu, njegovim fizikalno-kemijskim karakteristikama, topljivosti, ciljanoj koncentraciji, kao i o specifičnostima tehnike koja se primjenjuje za analizu. Dodatno, važan parametar kod odabira otapala za ispitivani uzorak je i stabilnost analita u otopini.

Vodena otapala i smjese organskih otapala s vodom/vodenim otapalima, predstavljaju najčešća otapala za pripremu uzoraka kod kromatografskih analiza. Niz prednosti kao što su netoksičnost, slaba snaga eluiranja, vrlo slaba reaktivnost te jednostavnost primjene čine vodu poželjnim otapalom kod reverzno fazne tekućinske kromatografije visoke djelotvornosti. Ipak, razgradnja analita u prisustvu vode jedan je od najčešćih oblika razgradnje [1], što može imati znatan utjecaj na točnost analize.

U predstavljenoj studiji, unatoč dobroj topljivosti analita u vodenim otapalima uočena je jako brza razgradnja, zbog čega je bila potrebna zamjena vodenog otapala organskim. Ispitivani analit pokazao se dobro topljiv u dimetilsulfoksid-u (DMSO), čime je to otapalo postalo otapalo izbora za pripremu uzorka. Međutim, nakon zamjene otapala uočena je pojava i rast nepoznatog onečišćenja koje nije bilo prisutno u uzorku pripremljenom s vodenim otapalom. Primjenom spregnute tehnike tekućinske kromatografije ultra visoke djelotvornosti i spektrometrije masa određena je m/z vrijednost za nepoznato onečišćenje. Dobiven je rezultat za 16 Da veći od m/z vrijednosti određene za glavni analit, temeljem čega je zaključeno da DMSO uzrokuje oksidaciju i najvjerojatnije nastajanje N-oksidnog onečišćenja. Brzina reakcije nastajanja N-oksidnog onečišćenja je pH-ovisna reakcija i dokazano je znatno sporija u slučaju kada je analit, koji je sklon oksidaciji, u protoniranom obliku [1]. Dodavanjem razrijeđene fosforne kiseline (1%) u DMSO (1:9, v/v) usporena je reakcija razgradnje oksidacijom, postignuta je veća stabilnost analita i omogućena je točna analiza uzorka. Stabilnost otopine koja je inicijalno bila vrlo mala (< 1 min) povećana je na 40 minuta, čime je omogućena rutinska priprema uzoraka, te je znatno smanjen utjecaj pripreme uzoraka na rezultate analize.

Reference

[1] S. W. Baertschi, K. M. Alsante i R. A. Reed, *Pharmaceutical Stress Testing: Predicting Drug Degradation*, Informa Healthcare, London, 2011.

**Ferrocene-containing asymmetric curcuminoid pyrazoles – new
potentially biologically active compounds**
**Ferrocenski asimetrični kurkuminoid-pirazoli – novi
potencijalno biološki aktivni spojevi**

Veronika Kovač, Tea Lukačević

Department of Chemistry and Biochemistry, Faculty of Food Technology and Biotechnology,
University of Zagreb, Croatia

E-mail: vkovac@pbf.hr

Curcuminoids are the most active ingredients of turmeric rhizome (*Curcuma* species – Zingiberaceae) that originate from India, Southeast Asia and Indonesia, amongst which curcumin (1,7-bis-(4-hydroxy-3-methoxyphenyl)-1,6-heptadiene-3,5-dione) is the most studied and showed a wide range of interesting biological activities, such as anti-inflammatory, antioxidant, antimicrobial, neuroprotective, antimutagenic, anticarcinogenic and chemopreventive activities [1,2]. In spite of its broad spectrum of activities and non-toxicity even at high dosages, curcumin has poor oral bioavailability due to its low water and plasma solubility as well as its instability under physiological conditions which limits its clinical application [3,4]. Whereas presence of the methylene group and β -diketone moiety contributes to rapid degradation of curcumin, different curcumin analogues without β -diketone moiety have been synthesized and they mostly showed retained or increased various biological activities [2]. Notable among these synthetic compounds are symmetric and asymmetric curcuminoid pyrazoles, in which 1,3-diketone-enol system has been masked and rigidized with heterocyclic pyrazole ring. Due to their interesting pharmacological properties they are subject of many research papers [5]. Herein the synthesis of new asymmetric curcuminoid pyrazoles containing the ferrocene moiety is presented (Figure 1), whose biological evaluation, such as antioxidant, antimicrobial and cytotoxic activity, will be studied.

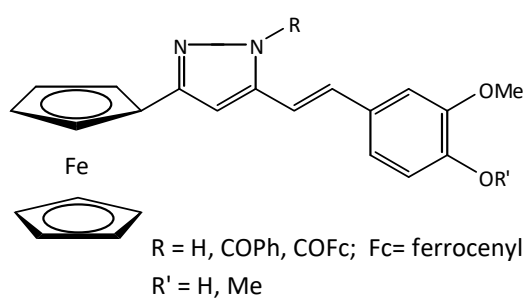

Figure 1: Ferrocene-containing curcuminoid pyrazoles.

References

- [1] A. R. Reddy, P. Dinesh, A. S. Prabhakar, K. Umasankar, B. Shireesha and M. B. Raju, *Mini Rev. Med. Chem.* **13** (2013) 1769-1777.
- [2] K. Bairwa, J. Grover, M. Kania and S. M. Jachak, *RSC Adv.* **4** (2014) 13946-13978.
- [3] P. Anand, A. B. Kunnumakkara, R. A. Newman and B. B. Aggarwal, *Mol. Pharm.* **4** (2007) 807-818.
- [4] M. A. Tomren, M. M. Másson, T. Loftsson, H. H. Tønnesen, *Int. J. Pharm.* **338** (2007) 27-34.
- [5] R. M. Claramunt, C. I. Nieto, D. Sanz and J. Elguero, *Afinidad LXXIV* **576** (2016) 259-268.

Synthesis and antiproliferative activity of adamantyl kojic acid derivatives Sinteza i antiproliferativni učinak adamantilnih derivata kojične kiseline

Vesna Petrović Peroković,¹ Željka Car,¹ Andrea Usenik,¹ Teuta Opačak-Bernardi,²
Andrea Jurić,³ Srđanka Tomić¹

¹Department of Chemistry, Faculty of Science, University of Zagreb, Zagreb, Croatia

²Faculty of Medicine, Josip Juraj Strossmayer University of Osijek, Osijek, Croatia

³Department of Chemistry, Josip Juraj Strossmayer University of Osijek, Osijek, Croatia

E-mail: vpetrovi@chem.pmf.hr

Kojic acid is a chelating compound and a common fungal metabolite widely used primarily in the preparation of cosmetic biomaterials and skin care products [1]. Numerous studies also showed that kojic acid and its derivatives exhibit other various biological activities [2,3]. In view of our previous findings on the adamantyl pyridinone derivatives and our continuous investigation of their biological activity [4] we wanted to extend our research further and explore the influence of the adamantyl group on the biological activity of pyranone system as well.

Thus, esters of kojic and adamantan-1-ylacetic acid were prepared using efficient synthetic methods in good yields and evaluated for their *in vitro* antiproliferative activity on 4 cancer cell lines (K562, HeLa, Caco-2, NCI-H358) as well as on normal cells (MDCK). Compounds showed good to moderate *in vitro* antiproliferative activity with IC₅₀ values ranging from 13.1 to 43.0 μM. It seems that the presence and adequate position of the adamantyl acyl group or chlorine atom is a prerequisite for their antitumor activity. The presence and the position of the adamantyl acyl unit were also the important structural parameters that governed antiproliferative activity of our previously investigated pyridin-4-one derivatives.

References

- [1] J. Brtko, L. Rondahl, M. Ficková, D. Hudecová, V. Eybl and M. Uher, *Cent. Eur. J. Public Health* **12** (2004) S16-S18.
- [2] S. Emami, E. Ghafouri, M. A. Faramarzi, N. Samadi, H. Irannejad and A. Foroumadi, *Eur. J. Med. Chem.* **68** (2013) 185-191.
- [3] M. Ficková, E. Pravdova, L. Rondhal, M. Uher and J. Brtko, *J. Appl. Toxicol.* **28** (2008) 554-559.
- [4] V. Petrović Peroković, Ž. Car, T. Opačak-Bernardi, I. Martin-Kleiner, M. Kralj and S. Tomić, *Mol. Divers.* **21** (2017) 881-891.

Acknowledgment: This research was fully supported by the Croatian Science Foundation (projects PEPTGLYCOSAR, IP-2014-09-7899).

Molecular docking study of a novel series of pyrazolines as potential inhibitors of phosphodiesterase type 5 (PDE5)

Istraživanje nove serije pirazolina kao potencijalnih inhibitora fosfodiesteraze tipa 5 (PDE5) metodom molekularnog uklapanja

Vesna Rastija,¹ Maja Molnar,² Harshad Brahmbhatt²

¹Faculty of Agrobiotechnical Sciences, Josip Juraj Strossmayer University of Osijek, Osijek, Croatia

²Faculty of Food Technology, Josip Juraj Strossmayer University of Osijek, Osijek, Croatia

E-mail: vrastija@pfos.hr

Phosphodiesterase type 5 (PDE5) is a cyclic guanosine monophosphate (cGMP)-specific enzyme and mostly expressed in smooth muscle tissue of corpus cavernosum, heart, lung, platelets, prostate, urethra, bladder, liver, brain, and stomach. Inhibitors of PDE5, prevent the hydrolysis of cGMP and become effective treatment to diseases associated with low cGMP level, such as pulmonary arterial hypertension [1]. It has been well-documented that pyrazole-containing compounds exhibit diverse chemotherapeutic potentials, such as antileukemic and antiproliferative agents. Beside, halogenated organic compounds has been widely use as many drug candidates [2]. Recently, we have synthesized a novel series of halogenated pyrazolines. Molecular docking study was performed to explain *in silico* the binding interaction with the PDE5 (PDB: 4oew). Molecular docking has confirmed that compound 5-(2,6-dimethoxyphenyl)-3-(4-fluorophenyl)-4,5-dihydro-1H-pyrazole-1-carbaldehyde has the lowest total energy binding ($-105,69 \text{ kcal mol}^{-1}$). The binding interactions of the most active compound have shown strong hydrogen bonding and van der Waals interactions with the target protein.

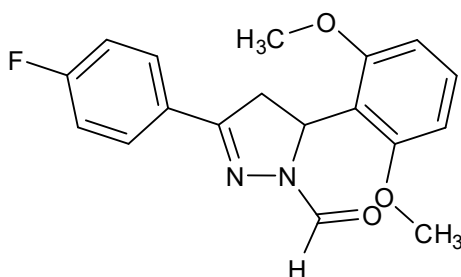

Figure 1: Molecular structure of derivate of pyrazoline as the most promising inhibitor of phosphodiesterase type 5.

References

- [1] J. Ren, Y. He, W. Chen, T. Chen, G. Wang, Z. Wang, Z. Xu, X. Luo, W. Zhu, H. Jiang, J. Shen and Y. Xu, *J. Med. Chem.* **57** (2014) 3588-3593.
- [2] S. A. F. Rostom, M. H. Badr, H. A. A. El Razik, H. M. A. Ashour and A. E. A. Wahab, *Arch. Pharm. Chem. Life Sci.* **344** (2011) 572-587.

**Estimation of the random correlation level of molecular descriptors in
structure-property modeling**
**Izračun razine nasumične korelacije molekularnih deskriptora u modeliranju
odnosa između strukture i svojstva**

Viktor Bojović,¹ Jadranko Batista,² Ana Amić,³ Bono Lučić¹

¹NMR Center, Ruđer Bošković Institute, Zagreb, Croatia

²University of Mostar, Faculty of Science and Education, Mostar, Bosnia and Herzegovina

³Department of Chemistry, Josip Juraj Strossmayer University of Osijek, Osijek, Croatia

E-mail: viktor.bojovic@irb.hr

Few years after the introduction of structure-property/activity models [1], the research community has become aware that some correlations can be obtained by chance [2]. In models relating structure of molecules described by molecular structural descriptors and their properties, the level of chance correlation present in each model is usually estimated by different randomization procedures. Such an approach is a part of validation protocols defined for structure-toxicity models used in environmental protection [3]. It came out that an appropriate model should have a smaller number of significant molecular descriptors containing maximal amount of useful and stable structural information. Stability of structural information means that the values of descriptor should not be significantly changed upon small conformational structural changes. However, many molecular descriptors calculated for most data sets are highly monotonous [4]. By performing intensive simulations of correlations between two randomized variables, we can obtain information about the distribution of chance correlation coefficients. The information content in a variable will be related to the range of random correlation with variables having the same (or similar) distribution, as well as with variables having arbitrary distributions. The level of minimal, maximal and the most probable chance correlation will be calculated and related to the distribution of descriptors. Analysis will be made on two-class classification variables, and an analogy with results for other variables will be established. Obtained results and conclusions will be used to define new steps in validation procedure for estimating the quality of structure-property models.

References

- [1] C. Hansch and T. J. Fujita, *J. Am. Soc.* **86** (1964) 1616-1626.
- [2] J. G. Topliss and R. J. Costello, *J. Med. Chem.* **15** (1972) 1066-1068.
- [3] Guidance Document on the Validation of [(Q)SAR] Models, ENV/JM/MONO(2007)2, 2017.
- [4] Talete srl, DRAGON program, www.talete.mi.it.

Acknowledgment: The work of doctoral student Viktor Bojović has been fully supported by the “Young researchers' career development project – training of doctoral students” of the Croatian Science Foundation funded by the European Union from the European Social Fund.

Halogen bonding proclivity of the morpholinyl fragment oxygen atom in cocrystal building blocks

Mogućnost nastajanja halogenske veze s kisikovim atomom morfolinskog fragmenta u građevnim blokovima kokristala

Vinko Nemec, Dominik Cinčić

Kemijski odsjek, Prirodoslovno-matematički fakultet, Sveučilište u Zagrebu, Zagreb, Hrvatska

E-pošta: vnemec@chem.pmf.hr

Kisikovi atomi su, uz dušikove atome, među najčešće korištenim i najzastupljenijim akceptorima halogenske veze [1]. Pretragom baze podataka *Cambridge Structural Database* za motiv halogenske veze između atoma broma ili joda i morfolinskog kisikova atoma pronađena su samo 23 podatka, od čega su tri slučaja kokristali s halogeniranim perfluoriranim donorima halogenske veze. Od njih, dva su kokristali morfolina s 1,4-dijodtetrafluorbenzenom odnosno 1,4-dibromtetrafluorbenzenom, dok treći odgovara kokristalu morfolinskog adukta koordinacijskog spoja kobalta(II) s 1,4-dijodtetrafluorbenzenom. Kako bi istražili mogućnost nastajanja halogenske veze s periferno smještenim kisikovim atomom morfolinskog fragmenta većeg građevnog bloka, reakcijom u otopini sintetiziran je imin izveden iz 2-hidroksi-1-naftaldehida i *N*-aminomorfolina, **nam**, a zatim iz smjese imina i bakrova(II) acetata monohidrata i odgovarajući metalni koordinacijski spoj, $\text{Cu}(\text{nam})_2$.

Za eksperimente kokristalizacije odabrano je šest donora halogenske veze različitog geometrijskog razmještaja donorskih atoma ili različite donorske jakosti: 1,4-, 1,3- i 1,2-dijodtetrafluorbenzen, jodpentafluorbenzen, 1,4-dibromtetrafluorbenzen i 1,3,5-trijodtrifluorbenzen. Pretraživanje nastajanja kokristalâ provedeno je mehanokemijskim putem, mljevenjem smjese reaktanata uz prisutnost male količine tekućine, te je utvrđeno da **nam** daje kokristale sa svih šest donora, a $\text{Cu}(\text{nam})_2$ samo s tri. Kristalizacijom iz otopine dobiveno je pet jediničnih kristala koji su zatim okarakterizirani difrakcijom rentgenskog zračenja. U svim je strukturno okarakteriziranim kokristalima prisutna halogenska veza $\text{X}\cdots\text{O}$ između donorskog atoma halogena i kisikova atoma morfolinskog fragmenta, što ukazuje na to da je takav kisikov atom dobar akceptor halogenske veze i ima potencijal u kristalnom inženjerstvu. Nadalje, parametar relativnog skraćenja tih halogenskih veza je u rasponu 13,2 – 16,6 %, iz čega se može zaključiti da je riječ o jakim halogenskim vezama. Termička stabilnost kokristalâ imina istražena je razlikovnom pretražnom kalorimetrijom, i može se povezati s brojem i vrstom halogenskih veza, kao i ostalih prisutnih usmjerenih interakcija.

Reference

- [1] C. R. Groom, I. J. Bruno, M. P. Lightfoot i S. C. Ward, *Acta Cryst. B* **72** (2016) 171-179.
- [2] D. Cinčić, T. Friščić i W. Jones, *Chem. Eur. J.* **14** (2008) 747-753.
- [3] G. Lapadula, N. Judaš, T. Friščić i W. Jones, *Chem. Eur. J.* **16** (2010) 7400-7403.

Influence of structurally similar compounds on crystal forms of Entacapone Utjecaj srodnih spojeva na kristalne forme entakapona

Vitomir Vušak,¹ Ernest Meštrović^{1,2}

¹PLIVA Croatia Ltd., Zagreb, Croatia

²Current address: Xellia d.o.o., Zagreb, Croatia

E-mail: Vitomir.Vusak@pliva.com

Polymorphism in Active Pharmaceutical Ingredients (API) is a widespread phenomenon that has been observed in more than half of known pharmaceutical substances [1]. Different polymorphs typically have different physical and chemical properties, such as solubility, melting point, *etc.* These differences may affect the production process (filtration, miscibility), but also can change stability and bioavailability of the active substances in the final dosage form [2]. Therefore, the process of crystallization and obtaining desired polymorph of certain particle properties is one of the most important challenges in the selection and application of API.

As described in literature, in several cases the addition of small amount of impurities (additives) had the influence on nucleation kinetics, crystal growth and morphology [3]. However, only a small number of articles describe the impact of impurities on crystallization of API.

Entacapone (Figure 1) is a selective and reversible inhibitor of catechol-*O*-methyltransferase enzyme and is used together with the active substances Levodopa and Carbidopa in the treatment of symptoms of Parkinson's disease. It is known that Entacapone shows polymorphism and 9 different polymorphic forms have been described. The influence of related compounds on crystallization outcome and variability of the Entacapone polymorphism will be presented.

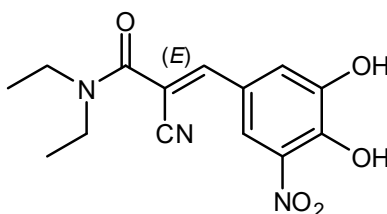

Figure 1: Structure of Entacapone.

References

- [1] P. H. Karpinski, *Chem. Eng. Technol.* **22** (2006) 233-237.
- [2] E. H. Lee, *Asian J. Pharm.* **9** (2014) 163-175.
- [3] A. R. Klapwijk, E. Simone, Z. K. Nagy and C. C. Wilson, *Cryst. Growth Des.* **16** (2016) 4349-4359.

Synthesis and characterization of selected *N,N'*-substituted bis(pyridinium aldoximes) and their pentacyano(pyridinium aldoxime)ferrate(II) complexes
Sinteza i karakterizacija odabranih *N,N'*-supstituiranih bis(piridinijevih aldoksima) i njihovih pentacijano(piridinij-aldoksim)ferat(II)-kompleksa

Vladimir Damjanović,¹ Danijela Cvijanović,¹ Jasna Lovrić,¹ Blaženka Foretić¹

¹Department of Chemistry and Biochemistry, School of Medicine, University of Zagreb, Zagreb, Croatia

E-mail: vladimir.damjanovic@mef.hr

Aldoxime derivatives of pyridinium cation are biologically active compounds having potential pharmacological application. As strong nucleophilic agents in aldoximate zwitterion form, $R\text{-Py}^+\text{-C(H)=N-O}^-$, they are used as effective reactivators of the human acetylcholinesterase inhibited by organophosphorus compounds (e.g. pesticides or chemical warfare nerve agents). The biological function and pharmacological effects of pyridinium aldoximes are closely related to their structural features, acidity of aldoxime functional group and their capability to coordinate to metal ions. Aquapentacyanoferrate(II) ion, $[\text{Fe}(\text{CN})_5(\text{OH}_2)]^{3-}$, represents a structural model of important octahedrally coordinated iron(II) centres found in protein macromolecules. The labile sixth coordination site and great stability of pentacyanoferrate(II) moiety in aquapentacyanoferrate(II) ion make it a good selective probe for the investigation of ambidentate ligand reactivity and the coordination mode. *N,N'*-bis(pyridinium-2-aldoxime)tetramethylene dibromide (QMB2-2Br) and its 3-isomer (QMB3-2Br) and 4-isomer (QMB4-2Br) were used to explore the influence of the position of aldoxime group on pyridinium ring on their properties and reactivity towards $[\text{Fe}(\text{CN})_5(\text{OH}_2)]^{3-}$. Ionization ability in the order $\text{QMB2} > \text{QMB4} > \text{QMB3}$, determined in aqueous media, was found to be in good agreement with their structural differences and consequent resonance stabilization of their aldoximate zwitterions. The kinetic study on the formation and dissociation of the corresponding $[\text{Fe}(\text{CN})_5(\text{QMB})]^{(3-n)-}$ complexes was performed in buffered aqueous media in the pH range 4–11 at 25 °C and deduced kinetic parameters have been correlated with σ - and π -bonding properties of the examined bis(pyridinium aldoxime) ligands. The notable influence of the ligands' isomerism on their reactivity towards aquapentacyanoferrate(II) ion was obtained. The established decrease of the formation rate constants in the order $\text{QMB3} > \text{QMB4} > \text{QMB2}$ was in accordance with the increasing steric hindrance. The slightly pH-dependent dissociation rates were found, which, along with the distinctive position of the MLCT band in the electronic absorption spectra, strongly supported the *N*-coordination of the aldoxime group. Furthermore, all complexes can be classified as labile while the ligands have more pronounced σ -donor than π -acceptor ability. Spectroscopic, elemental and thermogravimetric analysis of the isolated solids supports the fact that all complexes are mononuclear pentacyano(QMB)ferrates(II).

Complexation of homocyclopeptides with halides and oxoanions in acetonitrile and dimethyl sulfoxide

Kompleksiranje homociklopeptida s halogenidima i oksoanionima u acetonitrilu i dimetilsulfoksidu

Gordan Horvat,¹ Siniša Tarana,¹ Nikolina Vidović,² Nikola Cindro,¹ Giovanna Speranza,² Vladislav Tomišić¹

¹Department of Chemistry, Faculty of Science, University of Zagreb, Zagreb, Croatia

²Università degli Studi di Milano, Milan, Italy

E-mail: ghorvat@chem.pmf.hr

Cyclopeptides are promising class of anion receptors owing to the spatial proximity of backbone amide groups and also to the variety of sidechain substituents that can affect the receptor properties [1-3]. Complexation affinities of three cyclopeptide derivatives (Figure 1) for halide ions, thiocyanate and oxoanions were studied in acetonitrile and dimethyl sulfoxide. Ligand **L1** is a pentaleucine cyclopeptide derivative whereas the other two cyclopeptidic ligands are comprised of lysine subunits protected by *tert*-butylcarbonyl (BOC) group. Ligand **L2** is built out of four such subunits whereas ligand **L3** contains five of them. Stability constants of **L1**, **L2** and **L3** complexes with studied anions were determined by means of microcalorimetric and ¹H NMR titrations. To get more detailed insight into the binding of anions by the investigated cyclopeptide derivatives, classical molecular dynamics simulations were carried out.

The ligands showed larger affinity for all anions in acetonitrile than in dimethyl sulfoxide. It was found that the stability of the anion complexes of pentameric compounds **L2** and **L3** was higher when compared to the complexes of tetrameric ligand **L1**. The results of ¹H NMR titrations and molecular dynamics simulations indicated that the bound anions were coordinated by the amide groups of cyclopeptide receptors. In the case of **L1** and **L2** complexes with H₂PO₄⁻ anion, the participation of carbamate protons in the anion coordination was observed.

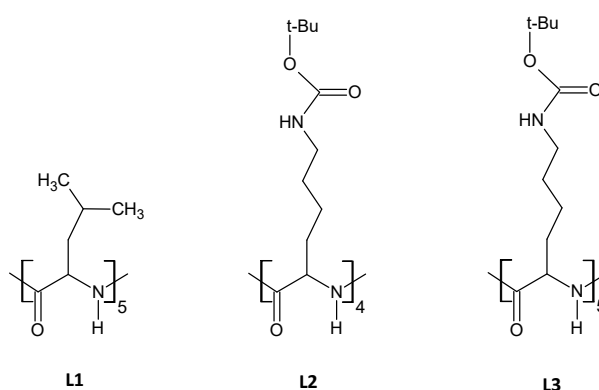

Figure 1: Structures of cyclopeptide ligands.

References

- [1] S. Kubik, *Acc. Chem. Res.* **50** (2017) 2870-2878.
- [2] R. B. P. Elmes and K. A. Jolliffe, *Chem. Commun.* **51** (2015) 4951-4968.
- [3] P. A. Gale, *Chem. Commun.* **47** (2011) 82-86.

Reactions of copper(II) and nickel(II) hexafluoroacetylacetonates with pyridine-based amides: synthesis and characterization. Reakcije heksafluoroacetilacetonatnih kompleksa bakra(II) i nikla(II) s amidnim derivatima piridina: sinteza i karakterizacija.

Željka Soldin,¹ Dijana Kos,¹ Boris-Marko Kukovec,² Marijana Đaković¹

¹Department of Chemistry, Faculty of Science, University of Zagreb, Zagreb, Croatia

²Department of Physical Chemistry, Faculty of Chemistry and Technology, University of Split, Split, Croatia

E-mail: zeljka@chem.pmf.hr

The rational design of functional molecular solids is one of the main challenges in crystal engineering [1,2]. Properties of crystalline solids are closely connected with the manner in which building units are aligned and linked together in the solid state. Understanding and controlling noncovalent interactions, in particular hydrogen bonds, is essential for establishing reliable connections between molecular and supramolecular structure. Strong directionality, sufficient strength, tunability and selectivity of hydrogen bonds enables synthesis of desired supramolecular architectures. The employing of rather weak and reversible intermolecular interactions in the building of organic networks is well known, but their role as well as the role of conventional hydrogen bonds in the assembly of metal-containing architectures is still much less studied. In our attempts to control molecular geometry and supramolecular assembly we synthesized a series of copper(II) and nickel(II) coordination compounds. We employed neutral hexafluoroacetylacetonates, $[\text{Cu}(\text{hfa})_2(\text{H}_2\text{O})_2]$ and $[\text{Ni}(\text{hfa})_2(\text{H}_2\text{O})_2]$ (hfa^- = hexafluoroacetylacetonate ion) to react with N-heterocyclic ligands equipped with the amide functionality, and to produce our desired metal-containing building blocks. Hexafluoroacetylacetonate ligand was used due to the strong electron withdrawing capability of the terminal $-\text{CF}_3$ groups to lessen the hydrogen-bond acceptor capability of the donating oxygen atoms. On the fifth and sixth coordination site we introduced pyridine-based ligands (4-acetamidopyridine, 4-acpy; 4-propaneamidopyridine, 4-propy) bearing the amide group, well established supramolecular functionality in purely organic systems. The compounds were characterized by single crystal X-ray structure analysis and IR spectroscopy. Thermal stability of coordination compounds was investigated by TGA/SDTA analysis.

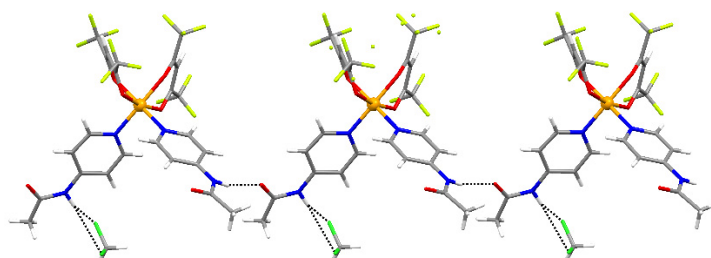

Figure 1: Hydrogen-bonded 1D chain in $[\text{Cu}(\text{hfa})_2(4\text{-acpy})_2]\cdot\text{CH}_2\text{Cl}_2$.

References

- [1] G. R. Desiraju, *J. Chem. Sci.* **122** (2010) 667-675.
- [2] C. B. Aakeröy, J. Desper and J. Valdés-Martínez, *CrystEngComm* **6** (2004) 413-418.

Development of ultra-high performance liquid chromatographic method for the analysis of Elvitegravir degradation products

Razvoj metode tekućinske kromatografije ultravisoke djelotvornosti za analizu razgradnih produkata lijeka elvitegravira

Zlata Lasić,¹ Irena Radić,¹ Luka Jerić,¹ Nives Galić²

¹Pliva Croatia Ltd., Zagreb, Croatia

²Faculty of Science, University of Zagreb, Zagreb, Croatia

E-mail: zlata.lasic01@pliva.com

Chemical stability of pharmaceutical molecules is a matter of great concern as it affects the safety and efficacy of the drug product [1]. Impurities in pharmaceutical product are the unwanted chemical compounds that remain within the active pharmaceutical ingredient (API), or are formed during production process or by degradation of API [2]. In order to provide a safe use of drugs, it is necessary to know structure and origin of impurities. Impurities can be toxic and carcinogenic and they can cause side effects and affect the activity and stability of the drug product. Regulatory agencies are requiring strict drug quality control, constant monitoring and impurity profiling. The drug purity testing includes analytical methods aimed at detection, identification, structural characterization and quantitative determination of impurities.

Elvitegravir (ELV) belongs to a novel class of anti-retroviral agents, integrase strand transferase inhibitors, which inhibit the integrase enzyme and prevent the virus replication [3]. The chemical name of ELV (Figure 1.) is 6(3-chloro-2-fluorobenzyl)-1-[(2S)-1-hydroxy-3-methylbutane-2-yl]-7-methoxy-4-oxo-1,4-dihydroquinoline-3-carboxylic acid. A new simple and rapid stability indicating method for determination of impurities in ELV active pharmaceutical ingredient has been developed and validated using reverse phase ultra-high performance liquid chromatography. The main peak of Elvitegravir from process and degradation impurities was successfully separated. DryLab software was used for optimizing chromatographic conditions: time gradient, column temperature and pH value of mobile phase. Degradation products caused by forced degradation were analyzed by LC-MS/MS coupled system. Possible ELV degradation pathways were predicted by analyzing obtained MS and MS/MS spectra.

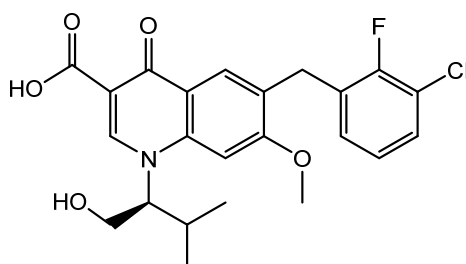

Figure 1: Chemical structure of Elvitegravir.

References

- [1] M. Blessy, R. D. Patel, P. N. Prajapati and Y. K. Agrawal, *J. Pharm. Anal.* **4** (2014) 159-165.
- [2] N. Rama Rao, S. S. Mani Kiran and N. L. Prasanthi, *Indian J. Pharm. Educ. Res.* **44** (2010) 301-310.
- [3] J. F. Mouscadet, O. Delelis, A. G. Marcelin and L. Tchertanov, *Drug Resist. Updat.* **13** (2010) 139-150.

Application of flow chemistry in process development of active pharmaceutical ingredients (APIs)

Primjena protočne kemije u razvoju procesa sinteze aktivnih farmaceutskih supstancija

Zrinka Mastelić Samardžić, Moris Mihovilović, Ozren Wittine, Aida Omerbašić, Vitomir Vušak
Teva, Pliva R&D, Zagreb, Croatia

E-mail: zrinka.mastelic-samardzic@pliva.com

The concept of "flow chemistry" defines a general range of chemical processes that occur in a continuous flowing stream, conventionally taking place in a reactor zone. The application of flow chemistry relies on the concept of pumping reagents using many reactors types to perform specific reactions. The most common types of reactors are plug flow reactors and column reactors, whilst for specific chemistries more sophisticated reactor designs might be needed. Flow equipment provides chemists with unique control over reaction parameters enhancing reactivity, increasing process safety or in some cases enabling new reactions.

In cases when processes in batch give unsatisfactory results regarding: yield, purity, safety, harsh reaction conditions and/or high costs, the solution can be found in transferring the reaction in the flow process.

This work represents different examples of transfer of batch processes to flow. All reactions that will be presented were tested on the laboratory scale during development of processes for active pharmaceutical ingredients (API) synthesis in Pliva R&D.

The aim of this work is to summarize advantages and disadvantages of flow processes. Main problems and challenges that were experienced during batch to flow transfer will be specially pointed out.

All experiments were performed in a Vapourtec flow RS400 system in different types of tube and chip reactors depending of type of tested reaction (Figure 1).

Reactions which gave the best results in flow are going to be considered as candidates for further development and scale up.



Figure 1: Vapourtec flow RS400 system.

Analytical study of soils in Dalmatia Analitička analiza tla na području Dalmacije

Zvonimir Jažo, Mateo Glumac, Josip Radić

Kemijsko-tehnološki fakultet, Sveučilište u Splitu, Split, Republika Hrvatska

E-pošta: mateo.glumac.bacola@gmail.com

Tlo je biološki aktivan, porozni medij koji je nastao u najvišem sloju Zemljine kore. Jedan je od osnovnih supstrata koji omogućuju život s ulogom skladištenja vode i nutrijenata, kao medij za filtraciju i razgradnju štetnih tvari i kao važan dio ciklusa ugljika te drugih elemenata kroz globalni ekosistem [1]. U ovom radu analizirane su pojedine kemijske vrste u tlu koje predstavljaju važnije faktore za rast i razvoj bilja, kao što su aktualna i izmjenjiva pH-reakcija tla, puferska sposobnost, ukupni sadržaj karbonata, sadržaj aluminija po Sokolovu, lakopristupačni fosfor po AL metodi, amonijački dušik po Nessleru, sadržaj ekvivalenta aktivnog vapna, udio organske tvari, sadržaj humusa te udio teških metala (Cu, Cd, Zn, Pb, Mn i Fe) [2].

Uzorci tla prikupljeni su u kolovozu 2018. na 14 lokacija diljem Dalmacije i otoka te jedan uzorak na području Ljubuškog u Bosni i Hercegovini. Kemijskom analizom prikupljenih uzoraka dobiveni su rezultati: aktualna pH reakcija tla bila je u rasponu od 7 do 8,5 pH jedinica; izmjenjiva pH reakcija u rasponu od 6,4 do 7,5 pH jedinica; puferska sposobnost u većini uzoraka bila je prema djelovanju kiselina; ukupni sadržaj karbonata kretao se u rasponu od 0 do 16 %; sadržaj aluminija po Sokolovu bio je u rasponu 0 do 14 mg / 100 g tla; lakopristupačni fosfor po AL metodi kretao se u rasponu od 5 do 105 mg/kg tla uz jednu iznimku iznosa 1029,78 mg kg⁻¹; amonijački dušik po Nessleru kretao se u rasponu od 40 do 280 mg kg⁻¹; sadržaj ekvivalenta aktivnog vapna kretao se u rasponu od 4,6 do 14,7 %; udio organske tvari kretao se u rasponu 4 do 35 %; sadržaj humusa kretao se u rasponu 0,6 do 3,4 %. Dobiveni rezultati u skladu su s rezultatima drugih autora [1,2]. Analiza teških metala dala je rezultate u rasponu: za bakar (15 – 283 mg kg⁻¹); kadmij (0,05 – 0,45 mg kg⁻¹); cink (3,7 – 186 mg kg⁻¹); olova (0 – 54 mg kg⁻¹); mangan (338 – 1398 mg kg⁻¹); i željezo (2720 – 20973 mg kg⁻¹). Analiza teških metala pokazala je da tla u Dalmaciji nisu zagađena teškim metalima [2,3]. Obradom dobivenih podataka uočeno je postojanje korelacije među nekim sastojcima tla.

Reference

- [1] G. Sposito, *The chemistry of soils*, Oxford University Press, 2008, New York.
- [2] V. Vukadinović, V. Vukadinović, *Ishrana bilja*, Sveučilište Josipa Jurja Strossmayera u Osijeku, Osijek, 2011.
- [3] G. Tóth, H. Herman, M. R. Da Silva, L. Montanarella, *Environ. Int.* **88** (2016) 299-309.

**Investigating the morphological properties of calcium oxalate monohydrate:
crystal formation in systems with different chemical complexity**
**Istraživanje morfoloških karakteristika kalcijeva oksalata monohidrata:
formiranje kristala u sustavima različite kemijske kompleksnosti**

Anamarija Stanković,¹ Silvija Šafranko,² Jasminka Kontrec,³ Branka Njegić Džakula,³ Daniel Mark Lyons,³ Berislav Marković,¹ Damir Kralj³

¹Department of Chemistry, J. J. Strossmayer University of Osijek, Croatia

²Faculty of Food Technology Osijek, J. J. Strossmayer University of Osijek, Croatia

³Ruđer Bošković Institute, Zagreb, Croatia

E-mail: astankovic@kemija.unios.hr

Urolithiasis, the formation of urinary stones in different parts of kidney or bladder, is a specific form of pathological biomineralization [1]. Recently, an increasing prevalence of kidney stones in industrial countries is observed and the interest of scientists to explain their pathogenesis with a special focus on calcium oxalate stones is renewed.

Calcium oxalates crystallize in the form of hydrated salts: thermodynamically stable calcium oxalate monohydrate [2,3] (COM, $\text{CaC}_2\text{O}_4 \cdot \text{H}_2\text{O}$), metastable dihydrate [4,5] (COD, $\text{CaC}_2\text{O}_4 \cdot 2\text{H}_2\text{O}$) and trihydrate [6,7] (COT, $\text{CaC}_2\text{O}_4 \cdot 3\text{H}_2\text{O}$).

The kidney stones formation under biological conditions can be triggered by various metabolic disorders such as: hypercalciuria, hypocitraturia, hyperoxaluria and the change in the urine acidity. The mechanisms and the conditions under which they crystallize are still not completely clarified [1].

In this work, the spontaneous precipitation and characterization of calcium oxalate monohydrate under conditions of hyperoxaluria ($c_i(\text{Ca}^{2+}) = 7.5 \cdot 10^{-3} \text{ mol dm}^{-3}$ and $c_i(\text{C}_2\text{O}_4^{2-}) = 6.0 \cdot 10^{-3} \text{ mol dm}^{-3}$) is reported. The experiments were conducted in a model system ($I_c = 0.3 \text{ mol dm}^{-3}$ NaCl, which imitates the physiological conditions in the human body) at two initial pH ($\text{pH}_i = 5.0$ and 9.0) and with the addition of amino acids reportedly important for pathologic biomineralization [8,9]. The amino acids selected for the addition are often found in the urine of healthy people and in the organic matrix which is an integral part of kidney stones. The reactant solutions were mixed under controlled hydrodynamic and thermodynamic conditions. Changes in the structure and morphology of precipitated calcium oxalate monohydrate were observed by means of PXRD, SEM, IR and TGA.

References

- [1] B. Hess, R. L. Ryall, J. P. Kavanagh, S. R. Khan, D. J. Kok, A. L. Rodgers and H. G. Tiselius, *Eur. Urol.* **40** (2001) 220-230.
- [2] Lj. Brečević and D. Kralj, *J. Cryst. Growth* **79** (1986) 178-184.
- [3] Lj. Brečević, D. Kralj and J. Garside, *J. Cryst. Growth* **97** (1989) 460-468.
- [4] C. Conti, M. Casati, C. Colombo, M. Realini, L. Brambilla and G. Zerbi, *Spectrochim. Acta A: Mol. Biomol. Spectrosc.* **128** (2014) 413-419.
- [5] P. Brown, D. Ackermann and B. Finlayson, *J. Cryst. Growth* **98** (1989) 285-292.
- [6] D. Škrtić, M. Marković, Lj. Komunjer and H. Füredi-Milhofer, *J. Cryst. Growth* **66** (1984) 431-440.
- [7] D. Škrtić, H. Füredi-Milhofer and M. Marković, *J. Cryst. Growth* **80** (1987) 113-120.
- [8] K. Kohri, M. Takada, Y. Katoh, K. Kataoka, M. Iguchi and T. Kurita, *Int. Urol. Nephrol.* **21** (1989) 9-16.
- [9] S. S. Atanassova, P. Panchev and M. Ivanova, *Amino Acids* **38** (2010) 1277-1282.

The application of surfactant sensor at optimization of composition in fabric softeners formulation

Primjena tenzidnog senzora pri optimiranju sastava formulacije oplemenjivača rublja

Maia Aničić,¹ Mateja Budetić,² Mirela Samardžić²

¹*Saponia d.d., Osijek, Republika Hrvatska*

²*Odjel za kemiju, Sveučilište Josipa Jurja Strossmayera u Osijeku, Osijek, Republika Hrvatska*

E-pošta: Maia.Anicic@saponia.hr

Tenzidi su sastavni dio većine deterdžentskih proizvoda, među kojima važno mjesto zauzimaju i oplemenjivači rublja. Na tržištu oplemenjivači rublja zauzimaju drugo mjesto po udjelu odmah poslije deterdženata za strojno pranje rublja. Oplemenjivači rublja prekrivaju površinu tekstilnih vlakana električki nabijenim tvarima, najčešće kationskim tenzidima, koji neutraliziraju površinu vlakna, koja je uglavnom negativno nabijena statičkim elektricitetom, dajući vlaknima mekoću, pahuljast izgled i ugodan miris. Koriste se u završnoj fazi strojnog ili ručnog pranja [1,2]. Kationski tenzidi predstavljaju glavne sastojke oplemenjivača rublja, premda njihovo djelovanje u sinergiji s ostalim sastojcima proizvoda izaziva i druge korisne učinke na vlakna i poboljšava antistatička svojstva. Stoga je izbor i koncentracija kationskog tenzida ili kombinacije kationskih tenzida, kao i njihova interakcija s ostalim sastojcima proizvoda najveći izazov za proizvođače oplemenjivača rublja [3].

Pri optimiranju sastava formulacije oplemenjivača rublja korišten je senzor vlastite konstrukcije s tekućom membranom na bazi višestjenčanih ugljikovih nanocjevčica (MWCNT) kemijski modificiranih sulfonatnim i cetilpiridinijevim ionom [4]. Ispitan je odziv senzora na kationske tenzide koji bi mogli biti dio formulacije oplemenjivača rublja. Optimirani su vrsta i udio kationskih tenzida u formulaciji te je ispitan utjecaj dodatka različitih koncentracija nekoliko vrsta silikona i njihovih stabilizatora na određivanje kationskih tenzida u formulaciji kako bi se razvio proizvod s optimalnim odnosom kvalitete i cijene proizvoda.

Reference

- [1] B. Wahle i J. Falkowski, *Rev. Prog. Color.* **32** (2002) 118-124.
- [2] K. Obendorf, V. Dixit i D. J. Woo, *Surfact. Deterg.* **12** (2009) 225-230.
- [3] J. A. Ackerman, *J. Am. Oil Chem. Soc.* **60** (1983) 1166-1169.
- [4] M. Hajduković, M. Samardžić, O. Galović, A. Széchenyi, M. Sak-Bosnar, *Sens. Actuators, B* **251** (2017) 795-803.

Spectroscopic and chemometric investigation of odorants Spektroskopsko i kemometričko istraživanje mirisnih spojeva

Marina Poljak,¹ Adriana Kendel,² Ines Primožič,² Snežana Miljanić,² Tomica Hrenar²

¹*Saponia d.d., Perfumery R&D, Osijek, Croatia*

²*Department of Chemistry, Faculty of Science, University of Zagreb, Zagreb, Croatia*

E-mail: Marina.Poljak@saponia.hr

Spectroscopic measurements of 82 selected odorants were performed using attenuated total reflectance (ATR) spectroscopy. The set included 6 different types of main odor notes of perfumery [1]. Principal component analysis (PCA) was carried out on a set of obtained spectra, as well as on their 1st and 2nd derivatives. The quality of PCA models was assessed using cross-validation methods and the optimal number of principal components for the representation in the reduced space was determined [2]. In the case of ATR spectra, the first principal component accounted for more than 50 % of the total variance among the samples and the optimal number of components was 5. The results were additionally improved using spectral derivatives.

Classification of these odorants was established and underlying spectral differences among the spectra were determined by investigating the principal component loadings [3]. These differences are caused by the variations in chemical composition. It was found that ATR analysis in combination with PCA can distinguish between various odor samples. Odorants subjected to the chemometric analyses can be divided into several major groups (clusters). Investigation of the principal component loadings determined the major differences among the ATR spectra regarding structural patterns present in the chemical structures. These differences are associated with the total number of aromatic and/or aliphatic functional groups and their structure, reflecting variations in composition of different odor notes.

References

- [1] P. Kraft, J. A. Bajgrowicz, C. Denis and G. Fráter, *Angew. Chem. Int. Ed.* **39** (2000) 2980-3010.
- [2] O. Jović, T. Smolić, I. Primožič and T. Hrenar, *Anal. Chem.* **88** (2018) 4516-4524.
- [3] A. Bosak, A. Ramić, T. Šmidlehner, T. Hrenar, I. Primožič and Z. Kovarik, *PLoS ONE* **13** (2018) e0205193.

Synthesis and characterization of new fluorescent indicator for selenium detection

Sinteza i karakterizacija novog fluorescentnog indikatora za detekciju selenija

Martina Andrijević, Andrea Dandić, Mateja Budetić, Mirela Samardžić, Aleksandar Sečenji
Department of Chemistry, Josip Juraj Strossmayer University of Osijek, Osijek, Croatia

E-pošta: mandrijevic@kemija.unios.hr

Selenij (Se) je element u tragovima koji u niskim koncentracijama djeluje kao važan mikroelement u živim organizmima, a u visokim koncentracijama može biti toksičan. Eksplozivni porast poznavanja uloge selenija u biološkim sustavima uzrokuje još veći porast potrebe za određivanjem njegove koncentracije u različitim uzorcima. Najčešće korištena metoda za određivanje selenija je atomska apsorpcijska spektroskopija (AAS) no njezin nedostatak je vrlo skupa instrumentacija. Alternativna metoda određivanja koncentracije selenija je fluorimetrija uz korištenje fluorescentnih indikatora [1] koji selektivno formiraju fluorescentni kompleks sa selenijem. Postojeći indikatori nisu dovoljno selektivni i osjetljivi da bi se AAS-metoda mogla u potpunosti zamijeniti fluorimetrijom. U ovome radu opisana je sinteza novog indikatora za selektivno kompleksiranje i fluorescentnu kvantifikaciju koncentracije selenija. Kao osnovni fluorescentni spoj izabran je 1,8 naftalimid [2] koji se pokazao kao izuzetno fotostabilna osnova za razvoj fluorescentnih indikatora s visokim kvantnim učinkom i velikim Stokesovim pomakom. Kao polazni spoj korišten je 4-brom-1,8-naftalanhidrid koji se u reakciji s primarnim aminima prevodi u supstituirani ciklički imid. U ovome radu za prevođenje anhidrida u imid korišteni su 2-(2-aminoetoksi)etanol, aminoetanol, propilamin, heksilamin i cikloheksilamin s ciljem reguliranja vodotopljivosti sintetiziranih imida. Slijedeća modifikacija podrazumijeva uvođenje 2-vicinalne amino skupine za kompleksiranje i Se (IV), koji se poznatim mehanizmom veže na nevezne elektronske parove dušikovih atoma i na taj način sprječava fotoinducirani prijenos elektrona (engl. *photo induced electron transfer*, PET), te se intenzitet fluorescencije pojačava razmjerno koncentraciji selenija.

Reference

- [1] G. Alfthan, *Anal. Chim. Acta.* **165** (1984) 187-194.
[2] S.-L. Wang, L. Zhong and Q.-H. Song, *Chem. Eur. J.* **24** (2018) 5652-5658.

Diastereo- and enantiopure helicene 2,2'-bipyridines: a new type of chiroptical switches

Dijastereomerno i enantiomerno čisti helicenski 2,2'-bipiridini: novi tip kirooptičkih prekidača

Irena G. Stará, Ivo Starý, Jiří Klívar, Michal Šámal, Lucie Bednárová
Institute of Organic Chemistry & Biochemistry CAS, Prague, Czech Republic

E-mail: stara@uochb.cas.cz

2,2'-Bipyridine along with a large family of its congeners have attained exceptional popularity across inorganic chemistry, organic chemistry and catalysis owing to their pronounced ability to form chelate complexes with transition metals in various oxidation states. However, helicene-derived 2,2'-bipyridines are so far rare in the literature and there is only a single example of their function as a chiroptical switch [1].

Herein, we developed a versatile asymmetric synthesis of the C_2 symmetric helicene 2,2'-bipyridines that relied on the double intramolecular [2+2+2] cycloisomerisation of a centrally chiral dicyanotetrayne or triyne (Figure 1). Starting from enantiopure centrally chiral building blocks, a multiple chirality relay took place; we reached an effective central-to-helical-to-axial chirality transfer that was controlled by various factors including the 1,3-allylic-type strain [2] leading to sterically constricted atropoisomers of the embedded 2,2'-bipyridine unit. Chiroptical properties of the helicene 2,2'-bipyridines were studied to find large responses to various solvents, acids and metal cations. The oxa[6]helicene derivative (-)-(M,R,R),(M,R,R)-2 exhibits an off/on switching ability when treated by acido basic/metal cation agents. Hence, it represents a new paradigm of effective chiroptical and fluorescence switches.

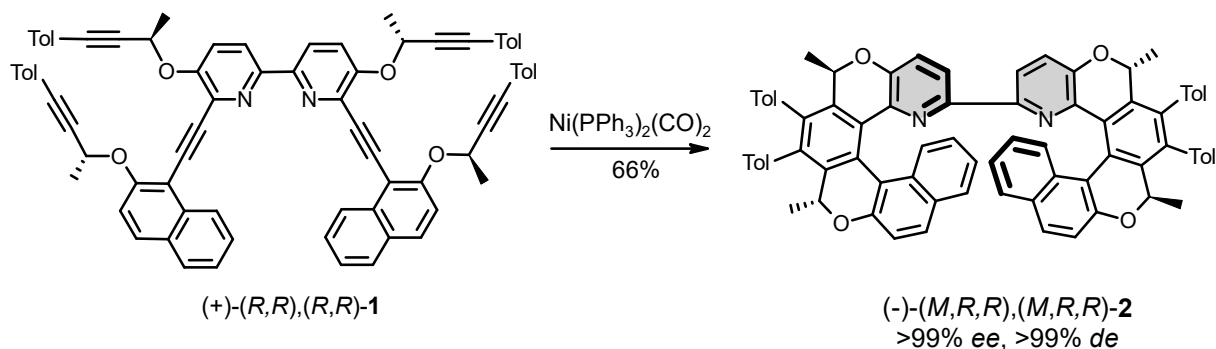

Figure 1: Asymmetric synthesis of the C_2 symmetric helicene 2,2'-bipyridines.

References

- [1] N. Saleh, B. Moorem, M. Srebro, N. Vanthuyne, L. Toupet, J. A. G. Williams, C. Roussel, K. Deol, G. Muller, J. Autschbach and J. Crassous, *Chem. Eur. J.* **21** (2015) 1673-1681.
- [2] (a) J. Žádny, A. Jančařík, A. Andronova, M. Šámal, J. Vacek Chocholoušová, J. Vacek, R. Pohl, D. Šámal, I. Císařová, I. G. Stará and I. Starý, *Angew. Chem. Int. Ed.* **51** (2012) 5857-5861; (b) M. Šámal, S. Chercheja, J. Rybáček, J. Vacek Chocholoušová, J. Vacek, L. Bednárová, D. Šámal, I. G. Stará and I. Starý, *J. Am. Chem. Soc.* **137** (2015) 8469-8474.

**POSTERSKA PRIOPĆENJA
KEMIJSKO I BIOKEMIJSKO INŽENJERSTVO**

***POSTER PRESENTATIONS
CHEMICAL AND BIOCHEMICAL ENGINEERING***

Preparation and characterization of lurasidone hydrochloride solid dispersions

Priprava i karakterizacija čvrstih disperzija lurasidon-hidroklorida

Joško Barbarić, Krunoslav Žižek

Sveučilište u Zagrebu, Fakultet kemijskog inženjerstva i tehnologije, Zagreb, Republika Hrvatska

E-pošta: barbaric@fkit.hr

Znatan broj nosintetiziranih djelatnih tvari farmaceutske industrije (između 40 i 60 %) odlikuje loša topljivost u fiziološkom rasponu pH-vrijednosti. Topljivost djelatne tvari nužan je preduvjet za njezinu apsorpciju kroz membrane probavnog sustava čime direktno utječe i na njezinu bioraspoloživost te na farmakološki učinak lijeka. Jedna od slabo topljivih djelatnih tvari je i lurasidon-hidroklorid (LRS HCl), atipični antipsihotik korišten u liječenju shizofrenije i bipolarnog poremećaja.

Brojne tehnike usmjerene su k povećanju topljivosti djelatnih tvari, a jedna od zastupljenijih je priprava čvrstih disperzija, smjesa fino raspršene djelatne tvari u inertnom nosaču (matrici).

U okviru ovog istraživanja pripravljene su čvrste disperzije lurasidon-hidroklorida i poli(vinil-pirolidona), polimera amorfnе strukture, primjenom dviju procesnih tehnologija: sušenja raspršivanjem i sušenja smrzavanjem (liofilizacija). S ciljem dokazivanja potencijalnih interakcija djelatne tvari i polimera, kao i određivanja faznog sastava mješavina, karakterizacija pripremljenih čvrstih produkata podrazumijeva primjenu niza instrumentalnih tehnika: diferencijalne pretražne kalorimetrije (DSC), rendgenske difrakcije analize praha (XRPD analiza), infracrvene spektroskopije s Fourierovim transformacijama (FTIR) i pretražne elektronske mikroskopije (SEM). Ispitan je utjecaj različitih metoda pripreve čvrstih disperzija na morfološka svojstva uzoraka, kao i na brzinu otpuštanja (otapanja) djelatne tvari pri definiranoj pH-vrijednosti ispitivanog medija. Rezultati ispitivanja ukazuju na potencijalnu primjenjivost čvrstih disperzija lurasidon-hidroklorida u razvoju mješavina za tabletiranja i, u konačnici, razvoja dozirnog oblika lurasidon-hidroklorida dobrih primjenskih sredstava.

Preparation and *in vitro* characterization of pharmaceutical pellets Priprava i *in vitro* karakterizacija farmaceutskih peleta

Matija Gretić, Gordana Matijašić, Mateja Štanfel, Nikola Rimac

Sveučilište u Zagrebu, Fakultet kemijskog inženjerstva i tehnologije, Zagreb, Republika Hrvatska

E-pošta: mgretic@fkit.hr

U farmaceutskoj industriji pelete se mogu definirati kao sferične čestice proizvedene aglomeriranjem sitnih prašaka ili granula djelatnih i pomoćnih tvari upotrebom odgovarajuće tehnologije. Istraživanje peleta potaknuto je njihovim terapijskim i tehnološkim prednostima u odnosu na konvencionalne dozirne oblike što je posljedica njihove višestruke prirode. Najčešće korištena tehnika peletiranja, ekstrudiranje i sferoniziranje, ima za cilj proizvesti pelete s uklopljenom djelatnom tvari kao i inertne pelete na koje se različitim postupcima nanosi djelatna tvar. Kako bi se kontroliralo oslobađanje djelatne tvari iz peleta one se često oblažu. Svojstva peleta znatno ovise o načinu pripreme, procesnim uvjetima, postupku sušenja i komponentama koje čine formulaciju.

U ovom radu istraživanje je provedeno u nekoliko koraka te se sastoji od pripreme peleta, njihove karakterizacije, nanošenja djelatne tvari i određivanja djelotvornosti ugradnje. Pripremljene su pelete mikrokristalne celuloze u kojima je dodatkom NaCl postignuta zadovoljavajuća poroznost. Dronedaron-hidroklorid u obliku nanosuspencije nanesen je na pelete vakuumskom impregnacijom nakon čega su pelete obložene hidroksipropil-metil-celulozom uz dodatak bojila kako bi se vizualizirala obloga. *In vitro* ispitivanjem dobiveni su profili oslobađanja djelatne tvari iz peleta te su opisani odgovarajućim kinetičkim modelom. Cilj ovog rada bio je proizvesti pelete i ispitati njihov potencijal kao nosača djelatne tvari dronedaron-hidroklorida. Povećanje sadržaja nastojalo se postići pripremom djelatne tvari u obliku nanosuspencije. Smanjenje veličine čestica djelatne tvari do nanometarskih dimenzija može znatno povećati njenu bioraspoloživost.

Extraction of metals, boron and phosphorus from waste animal fat using deep eutectic solvents

Ekstrakcija metala, bora i fosfora iz otpadne životinjske masti pomoću niskotemperaturnih eutektičnih otapala

Ana Petračić, Aleksandra Sander, Matija Cvetnić

Fakultet kemijskog inženjerstva i tehnologije Sveučilišta u Zagrebu, Zagreb, Hrvatska

E-pošta: apetracic@fkit.hr

Otpadne životinjske masti sadržavaju brojne nečistoće poput vode, metala, raznih elemenata u tragovima i slobodnih masnih kiselina. Kako bi masti bile prikladne za bazno kataliziranu transesterifikaciju, odnosno sintezu biodizela, potrebno ih je pročistiti. Cilj ovog rada je ekstrakcija metala, bora i fosfora iz sirovine jer ti elementi imaju loš utjecaj na skladišna i uporabna svojstva biodizela, odnosno mogu dovesti do oksidacije tijekom skladištenja te do stvaranja naslaga i začepljenja sustava dovoda goriva u automobilu.

Sadržaj metala (Na, K, Ca, Mg, Fe), bora i fosfora u otpadnoj životinjskoj masti određen je pomoću masenog spektrometra s induktivno spregnutom plazmom (ICP-MS). Uzorci su pripremljeni mikrovalnom digestijom uz prisustvo dušične kiseline i vodikova peroksida. Za pročišćavanje otpadne životinjske masti korištena su četiri različita niskotemperaturna eutektična otapala, na bazi kolin-klorida i kalijeva karbonata uz glicerol i etilen-glikol kao donore vodikovih veza, te dva adsorbensa na bazi bentonita. Provedeno je pročišćavanje u jednom stupnju (ekstrakcija i adsorpcija), u dva stupnja kombinacijom ekstrakcije i adsorpcije, odnosno kombinacijom dva otapala te ekstrakcija u tri stupnja uz promjenjiv maseni omjer otapala i sirovine.

Na temelju dobivenih rezultata može se zaključiti da je ekstrakcija učinkovitija od adsorpcije, s iznimkom otapala na bazi kalijeva karbonata koja nisu bila uspješna za uklanjanje kalija. Porast masenog omjera otapala i masti te broja stupnjeva ekstrakcije ne utječe u velikoj mjeri na učinkovitost procesa. Osim metala, bora i fosfora, tijekom ekstrakcije s otapalima na bazi kalijeva karbonata također se ekstrahiraju i slobodne masne kiseline.

Preparation and characterization of mini-tabs for oral delivery of lurasidone hydrochloride

Priprava i karakterizacija minitableta za oralnu primjenu lurasidon-hidroklorida

Krunoslav Žižek, Iva Gavran, Joško Barbarić

Sveučilište u Zagrebu, Fakultet kemijskog inženjerstva i tehnologije, Zagreb, Republika Hrvatska

E-pošta: kzizek@fkit.hr

Minitablete su višejedinični sustavi za oralnu primjenu lijeka. Relativno nov i atraktivan pristup pri formuliranju lijekova nudi brojne prednosti u usporedbi s monolitnim, ali i drugim višejediničnim dozirnim oblicima (pelete, mikrosfere i granule) te omogućuje točno i individualno doziranje prilagođeno ciljanoj populaciji bolesnika.

Lurasidon-hidroklorid (LRS HCl) koristi se u liječenju shizofrenije i bipolarnog poremećaja. Jedini komercijalno dostupan oblik tog atipičnog antipsihotika je konvencionalna tableta Latuda. Djelatnu tvar karakterizira niska topljivost u vodenom mediju te slaba apsorpcija u organizmu i niska bioraspoloživost lijeka. Stoga, cilj ovog istraživanja bio je pripremiti minitablete povećane topljivosti i brzine otpuštanja lurasidon-hidroklorida te pogodnih u liječenju epizodnih poremećaja shizofrenije.

Pripravljena je čvrsta disperzija LRS HCl u hidrofilnoj polimernoj matrici. Korištena je polukristalna polimerna tvar poli(etilen-glikol) 4000 te procesna tehnologija liofilizacije uz prethodno smrzavanje otopina kapljevitim dušikom. Uzorci su sušeni u liofilizatoru pedeset sati u uvjetima visokog vakuuma i niske temperature. Minimalan sadržaj vlage ukazao je na uspješno provedenu liofilizaciju svih uzoraka. Dobiveni liofilizati karakterizirani su rendgenskom difrakcijom praha, diferencijalnom pretražnom kalorimetrijom i Fourier-transformiranom infracrvenom spektroskopijom. Dobiveni difraktogrami ukazuju na kristalni fazni sastav svih mješavina. Sve mjerne tehnike upućuju na dobru pripremu čvrstih disperzija. Rezultati infracrvene spektroskopije i termogrami ukazuju na moguće postojanje fizikalnih interakcija između lurasidon-hidroklorida i polimerne matrice. Postizanjem bolje interakcije komponenata povećava se topljivost djelatne tvari, te posljedično i bioraspoloživost lijeka.

U pripravi minitableta korištene su čvrste disperzije LRS HCl u hidrofilnom poli(etilen-glikolu) te granule pomoćnih tvari manitola, natrijeve kroskarmeloze i poli(etilen-glikola). Primjenom ekscentrične tabletirke i prilagođene okrugle matrice dobivene su minitablete promjera 3 mm. Karakterizacija minitableta podrazumijevala je ispitivanje ujednačenosti masa minitableta, testiranje njihove raspadljivosti, te određivanje sadržaja djelatne tvari. *In vitro* ispitivanjima testirana je topljivost djelatne tvari te su utvrđeni profili njezina otpuštanja iz minitableta. Vrijeme raspadljivosti za sve minitablete manje je od 3 minute. Na uzorku od 10 minitableta nalazi se prosječno 85 % LRS HCl od ciljanog sadržaja. Profili otpuštanja u laboratorijskom okruženju te prisutnosti McIlvaineova pufera (pH = 3,8) ukazuju na brže otpuštanje djelatne tvari iz minitableta pripremljenih iz čvrstih disperzija liofilizata.

Continuous liquid-liquid extraction by deep eutectic solvents in a millireactor Kontinuirana kapljevinska ekstrakcija primjenom niskotemperaturnih eutektičnih otapala u milireктору

Anamarija Mitar, Marija Lukić, Jasna Prlić Kardum

Fakultet kemijskog inženjerstva i tehnologije Sveučilišta u Zagrebu, Hrvatska

E-pošta: jprlic@fkit.hr

Kako bi se uklonili sumporovi i dušikovi spojevi iz goriva, koji su glavni uzrok onečišćenja zraka (SO_x i NO_x) i nastajanja kiselih kiša, proveden je proces pročišćavanja modelnog FCC benzina kontinuiranom kapljevinskom ekstrakcijom s tri niskotemperaturna eutektična otapala (engl. *Deep Eutectic Solvent*, DES) i tri nanosuspenzije (NS) u milireктору izrađene proizvodnjom rastaljenim filamentom (engl. *Fused Filament Fabrication*, FFF).

U klasičnim postupcima hidrodiesulfurizacije (HDS) i hidrodienitrifikacije (HDN) pročišćavanje goriva provodi se pri visokim tlakovima (30 do 100 bar), visokim temperaturama (350 °C) i uz velike količine vodika i katalizatora. Ekstrakcija sumporovih i dušikovih spojeva iz goriva primjenom novih dizajniranih otapala, DES-ova dobra je alternativa spomenutim HDS i HDN procesima. Budući da se DES-ovi pripremaju jednostavno iz netoksičnih i obnovljivih komponenti, ekstrakcija se provodi pri blagim uvjetima te je za uklanjanje pojedinih sumporovih spojeva uspješnija od HDS procesa [1,2].

Milireaktori kružnog poprečnog presjeka kanala (ϕ 2,5 mm) i duljine 50 cm izrađeni su od polimernih materijala poli(mliječne kiseline) (PLA) i poli(etilen-tereftalat)-glikola (PETG) pri čemu nije uočeno odstupanje u rezultatima.

Odabrano je najbolje sekundarno otapalo, istražena mogućnost primjene nanosuspenzija te je ispitan utjecaj vremena zadržavanja, τ , na djelotvornost ekstrakcije. Sastav modelnog goriva, prije i nakon postupka pročišćavanja, određen je plinskom kromatografijom. Rezultati istraživanja pokazali su da je najbolje sekundarno otapalo pripremljeno od tetrabutilamonijeva bromida i mravlje kiseline, dok poboljšanje prijenosa tvari primjenom pripremljenih nanosuspenzija nije postignuto. Najbolja djelotvornost procesa postignuta je za vrijeme zadržavanja, $\tau \approx 6$ min.

Reference

- [1] J. Eßer, P. Wasserscheid i A. Jess, *Green Chem.* **7** (2004) 316-322.
- [2] M. Larriba, M. Ayuso, P. Navarro, N. Delgado-Mellado, M. Gonzales-Miquel, J. Garcia i F. Rodriguez, *ACS Sust. Chem. Eng.* **6** (2018) 1039-1047.

Effect of temperature in degradation of a real sample of biodegradable fraction from mixed municipal waste during composting
Utjecaj temperature u razgradnji realnog uzorka biorazgradljive frakcije iz miješanog komunalnog otpada kompostiranjem

Tomislav Domanovac,¹ Dajana Kučić Grgić,² Monika Šabić Runjavec,²

Marija Vuković Domanovac²

¹IPZ Uniprojekt TERRA, Zagreb

²Sveučilište u Zagrebu, Fakultet kemijskog inženjerstva i tehnologije, Zagreb

E-pošta: msabic@fkit.hr

Biorazgradljivi komunalni otpad je otpad koji se može razgraditi biološkim aerobnim ili anaerobnim postupkom i obuhvaća biološki razgradljive vrste otpada podrijetlom iz kućanstva i otpad koji je po prirodi i sastavu sličan otpadu iz kućanstva, sa znatnim udjelom u miješanom komunalnom otpadu. Kompostiranje je jedna od tehnologija recikliranja biorazgradljivog komunalnog otpada u stabilan produkt – kompost – koja se zbog okolišne prihvatljivosti sve više koristi. Razgradnju biorazgradljive tvari provode aerobni mikroorganizmi. Tijekom kompostiranja generira se toplina unutar reaktora što je posljedica egzotermne reakcije biorazgradnje i količina razvijene topline proporcionalna je oksidaciji organske tvari. Vrijednost temperature pri kojoj se postiže biorazgradnja ovisi o tvari koja se razgrađuje. Praćenje i održavanje temperature jedan je od najvažnijih dijelova upravljanja i vođenja sustava za kompostiranje.

U ovom radu provedena je aerobna obrada realnog uzorka biorazgradljive frakcije iz miješanog komunalnog otpada u reaktorskom sustavu. Konverzija hlapive tvari iznosila je do 55,7 %. Omjer C/N smanjio se s početne vrijednosti od 21,3 do 10,3. Vrijednost temperature kretala se do 64 °C uz trajanje termofilne faze od 3,5 dana. Na temelju eksperimentalnih rezultata izabran je kinetički model i procijenjeni su parametri modela. Reakcijska entalpija koja je iznosila 640,4 kJ kg_{HT}⁻¹ izračunata je iz mjerenih temperatura unutar reaktora uz pretpostavku da je oslobođena toplina proporcionalna napredovanju razgradnje organske tvari. Dobro slaganje modela s eksperimentalnim rezultatima ukazuje na mogućnost primjene modela u realnim uvjetima.

Pyridine and thiophene separation from hydrocarbon mixtures using DES based on choline chloride and propylene glycol – a LLE study
Odjeljivanje piridina i tiofena iz smjesa ugljikovodika primjenom DES-a na bazi kolin-klorida i propilen-glikola – istraživanje ravnoteže kapljevina-kapljevina

Kristina Zagajski Kučan, Marko Rogošić

University of Zagreb, Faculty of Chemical Engineering and Technology, Zagreb, Croatia

E-mail: kzkucan@fkit.hr

Classical methods for separation of mixtures into components involve the use of organic solvents which are volatile, potentially explosive and toxic. The trend is to replace harmful solvents with environmentally friendly ones. The mixture of choline chloride and propylene glycol in molar ratio of 1:3 (ChCl-PG 1:3) belongs to a group of environmentally friendly solvents called deep eutectic solvents (DES), which are characterized by low vapor pressure, non-flammability, biodegradability and simple preparation from non-toxic compounds. In this work, liquid-liquid equilibria for the six quasi-ternary systems involving one hydrocarbon component (*n*-hexane, *n*-heptane or *i*-octane), pyridine or thiophene and ChCl-PG 1:3 were experimentally determined at atmospheric pressure and 25 °C in order to investigate the potential of ChCl-PG 1:3 for the extraction of pyridine and thiophene from hydrocarbon mixtures. The equilibrium data were presented in terms of experimental tie lines and correlated with NRTL and UNIQUAC coefficient activity models. Moreover, physical properties of ChCl-PG 1:3 important for its use as an extractive solvent (density, viscosity, refractive index, electrical conductivity and thermal properties) were measured. The obtained results indicate that ChCl-PG 1:3 is more suitable for the removal of pyridine than thiophene from hydrocarbon mixtures.

Effect of Mg(OH)₂ addition on thermal properties of poly(vinyl chloride) Utjecaj dodatka Mg(OH)₂ na toplinska svojstva poli(vinil-klorida)

Miće Jakić, Jelena Jakić, Iva Radonić, Martina Vidović
Kemijsko-tehnološki fakultet, Sveučilište u Splitu, Hrvatska

E-pošta: mjakic@ktf-split.hr

Poli(vinil-klorid) (PVC) je široko primjenjivi plastomerni materijal koji se dobiva procesom polimerizacije vinil-klorid monomera. S obzirom na to da dobro reagira s različitim dodacima, poznato je više od stotinjak vrsta PVC-a koji se primjenjuju u raznim granama industrije, od građevinskog materijala do materijala za proizvodnju odjeće. S druge strane, PVC pokazuje i čitav niz nedostataka, odnosno glavni nedostatak je što do toplinske razgradnje dolazi relativno rano, već pri temperaturi tek nešto višoj od temperature staklastog prijelaza PVC-a [1]. Međutim, toplinska svojstva PVC-a mogu se mijenjati dodatkom različitih aditiva koji i u malim količinama mogu znatno promijeniti svojstva PVC-a. Zbog današnjih zahtjeva za očuvanjem okoliša nužno je istražiti nove mogućnosti modifikacije svojstava PVC-a ekološki prihvatljivim dodacima. Jedan od ekološki prihvatljivih dodataka je i magnezijev hidroksid, Mg(OH)₂, koji se uobičajeno koristi kao usporivač gorenja polimernih materijala [2-4]. U ovom radu istraživana je utjecaj dodatka Mg(OH)₂ dobivenog iz morske vode na toplinska svojstva PVC-a primjenom termogravimetrijske analize (TG) i diferencijalne pretražne kalorimetrije (DSC). Temeljem rezultata TG analize može se zaključiti kako dodatak Mg(OH)₂ do 5 mas. % poboljšava toplinsku stabilnost PVC-a. S druge strane, temeljem rezultata DSC analize može se zaključiti kako dodatak Mg(OH)₂ nema utjecaj na staklište PVC-a.

Reference

- [1] Z. Janović, *Polimerizacije i polimeri*, HDKI – Kemija u industriji, Zagreb, 1997., str. 332-339.
- [2] M. Schiller, *PVC Additives: Performance, Chemistry, Developments and Sustainability*, Carl Hanser Verlag GmbH & Co., München, 2015.
- [3] A. Ebdam, S. Jameh-Bozorghi, M. Yousefi and A. Niazi, *Bulg. Chem. Commun.*, Special issue (2017) 152-158.
- [4] D. Matlhomola Molefe, J. Labuschagne, W. Wilhelm Focke, I. van der Westhuizen and O. Ofosu, *J. Fire Sci.* **33** (2015) 493-510.

Numerical investigation of the membrane position effect on gas holdup and shear stress rate in bubble column with immersed membrane
Numeričko istraživanje utjecaja položaja membrane na zadržavanje plina i brzinu smičnog naprezanja u koloni s mjehurićima i uronjenom membranom

Veselin Iliev, Dessislava Moutafchieva
University of Chemical Technology and Metallurgy, Sofia, Bulgaria

E-mail: dmoutaf@uctm.edu

The aim of the present study is to determine the influence of the position of immersed membrane in a bubble column on gas holdup, shear strain rate and distribution of bubbles, by means of computational fluid dynamics (CFD) methods. A CFD model accounting for aeration and membrane configuration was developed. Membranes were located at three different positions, 0.5 or 0.10 m from the column wall. The simulation results were compared with those obtained for different axial membrane vertical distances ($H = 0.1, 0.2$ and 0.3 m) from the sparger with bubble diameters of 3 mm, 6 mm and 12 mm. The influence of the flow rate on the accumulation of sludge was estimated by calculating the shear stress rate near to the membrane surface. Although the aeration may scour the membrane surface and prevent the formation of cake layer, the effects of inlet air flowrate and the bubble diameter on the shear strain rate were also investigated. In the studied range of gas velocities (0.5 to 1.5 m s⁻¹), the highest value of 1.5 m s⁻¹ was found to provide the optimum aeration rate, at the vertical distance of the membrane module from the sparger of $H = 0.1$ m and at the bubble diameter of 3 mm. The influence of the bubble diameter on the shear stress rate values is more pronounced on the inner membrane surface. In addition, conical shaped membrane simulations were performed in order to study the influence of the membrane slope on the shear stress rate at the same air flowrate and bubble diameter. Average shear stress was found to increase with the increase of air flowrate as the membrane slope is changed.

Based on the obtained numerical results, it will be possible to define the optimum bubble size, membrane positioning, air flowrate and membrane bubble column design. CFD therefore provides a method for prediction of how the characteristics of the vessel affect the hydrodynamics and thus enables optimization of membrane bubble column design and performance.

Municipal wastewater reuse for irrigation by MBR and RO/NF processes Oporaba komunalne otpadne vode za navodnjavanje s MBR i RO/NF procesima

Davor Dolar, Klara Karadakić, Nina Čavarović, Marko Racar, Krešimir Košutić
University of Zagreb, Faculty of Chemical Engineering and Technology, Zagreb, Croatia

E-pošta: kkosutic@fkit.hr

Membranski bioreaktor (MBR), reverzna osmoza (RO) i nanofiltracija (NF) korišteni su za uporabu komunalne otpadne vode (KOV) Čakovec, Hrvatska u svrhu navodnjavanja poljoprivrednih površina. Parametri izlaznih struja uspoređeni su s propisanim vrijednostima Svjetske zdravstvene organizacije (WHO) i Organizacije za prehranu i poljoprivredu (FAO). Uvjeti rada u MBR-u bili su: ZW-1 ultrafiltracijska membrana u obliku šupljih vlakana površine 0,046 m², koncentracija mulja 12,47±1,38 g L⁻¹, vrijeme zadržavanja (HRT) 4,4 h, protok permeata 24,67±2,66 L m⁻² h⁻¹, temperatura 22,84±1,50 °C i aeriranje 20 L min⁻¹. MBR efluent dodatno je obrađivan s NF membranama (NF90 i NF270) te s RO membranom (XLE) pri tlaku od 12 bar.

MBR obradom KOV-a postignuto je visoko smanjenje kemijske potrošnje kisika (KPK), biokemijske potrošnje kisika (BPK₅), mutnoće u iznosima većim od 91 %, 95 % i 99 %, suspendiranih čestica (TSS) 100 %, dok je smanjenje električne provodnosti bilo svega oko 19 %. Dodatna obrada MBR efluenta s RO/NF membranama smanjila je ukupni otopljeni organski ugljik (DOC) i KPK u iznosima od 86 % i 71 %. Smanjenje električne provodnosti iznosilo je dodatnih 55 % s NF270, 94 % s NF90 i 95 % s XLE membranom.

MBR efluent nije zadovoljio WHO i FAO regulative s obzirom na slabo uklanjanje prisutnih soli, što je bilo i za očekivati za ZW-1 ultrafiltracijsku membranu. Dodatnom obradom s RO/NF membranama koncentracija soli (izražena električnom provodnošću) znatno je smanjena što je čak negativno utjecalo na kvalitetu dobivene vode namijenjene za navodnjavanje. Stoga je predloženo miješanje MBR efluenta i RO/NF permeata u omjeru 0,20:0,80 čime su zadovoljene propisane WHO i FAO vrijednosti.

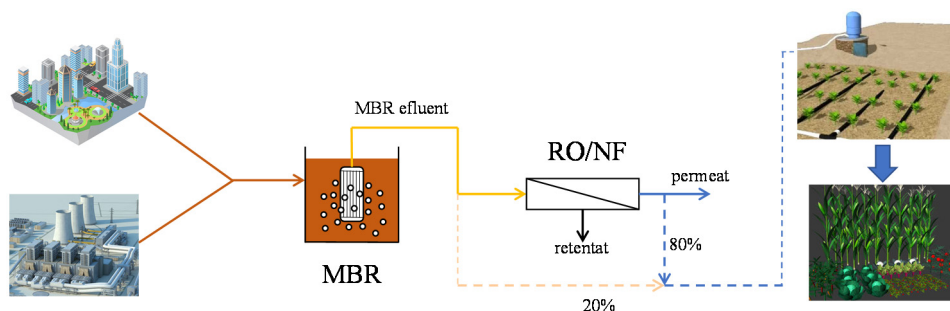

Slika 1: Shema procesa.

Napomena: Ovaj rad financiran je (1.492.908,72 HRK) u sklopu Programa Vlade Republike Hrvatske za poticanje istraživačkih i razvojnih aktivnosti u području klimatskih promjena za razdoblje od 2015. do 2016. godine uz podršku Ministarstva znanosti i obrazovanja, Ministarstva zaštite okoliša i prirode te energetske učinkovitosti i Hrvatske zaklade za znanost, u sklopu projekta Izravna oporaba komunalne otpadne vode za navodnjavanje membranskim tehnologijama (ReHOHMem) (PKP-2016-06-8522).

Preparation and characterization of amorphous solid dispersion obtained *via* spray drying technology
Priprava i karakterizacija amorfnе čvrste disperzije dobivene sušenjem raspršivanjem

Igor Nežić¹, Aleksandra Sander,² Ernest Meštrović^{1,3}

¹PLIVA Croatia LTD, Zagreb, Croatia

²Faculty of Chemical Engineering and Technology, Zagreb, Croatia

³Current address: Xellia d.o.o., Zagreb, Croatia

E-mail: igor.nezic@pliva.com

Drying is perhaps the oldest, most common and most diverse of chemical engineering unit operations. Over four hundred types of dryers have been reported in the literature while over one hundred distinct types are commonly available [1]. Spray drying, amongst other technologies, is a well-established technology for the production of amorphous products. It offers the possibility to modify powder characteristics such as particle size, particle morphology, crystallinity and the amount of residual solvent [2].

In this work, the possibility of obtaining a stable amorphous solid dispersion of 5-(4-(4-(5-Cyano-1*H*-indol-3-yl)butyl)piperazin-1-yl)benzofuran-2-carboxamide hydrochloride and hydroxypropyl methylcellulose in a spray-dryer was examined. Taking into account solubility of all ingredients, their crystallization and chemical stability, influence of material of construction on their stability, optimal system for spray drying process was chosen. A solution of the hydrochloride crystalline structure of the active pharmaceutical ingredient and polymer in a mixture of water and acetonitrile was dried at different temperatures, nozzle configurations and flow rates of nitrogen used for atomization, as well as the flow rates of the solution. The influence of the process conditions on the properties of the product was analyzed. The final dried products were characterized and identified with a variety of analytical and physical methods. The results showed that a stable amorphous solid dispersion of the high purity active pharmaceutical ingredient is obtained with a spray drying, and that the optimal conditions of the process are defined.

References

- [1] A. S. Mujumdar, *Guide to industrial drying: principles, equipment and new developments*, Colour Publications, Mumbai, 2004.
- [2] P. Thybo, L. Hovgaard, J. S. Lindeløv, A. Brask and S. K. Andersen, *Pharm. Res.* **25** (2008) 1610-1620.

Optimization of microreactor system for enzymatic synthesis of biodiesel from edible and waste oil

Optimizacija mikroreaktorskog sustava za provedbu enzimatске sinteze biodizela iz jestivog i otpadnog ulja

Martin Gojun, Anita Šalić, Bruno Zelić

Sveučilište u Zagrebu, Fakultet kemijskog inženjerstva i tehnologije, Zagreb, Hrvatska

E-pošta: mgojun@fkit.hr

Prekomjerno korištenje fosilnih goriva u zadnjih 50-ak godina i njihov negativan utjecaj na okoliš rezultirali su razvojem alternativnih izvora energije. Kada je riječ o transportu, biogoriva, kao što je biodizel, sve se više primjenjuju kao čista i obnovljiva zamjena za dizel porijeklom iz nafte. Prednosti biodizela, mješavine monoalkilnih estera dugolančanih masnih kiselina, u odnosu na dizel porijeklom iz nafte očituju se u njegovoj biorazgradljivosti i obnovljivosti te manjoj emisiji štetnih plinova, što posljedično predstavlja manji negativan utjecaj na okoliš. Između različitih procesa sinteze biodizela, transesterifikacija je najčešće korištena tehnika. Ovaj konvencionalni proces proizvodnje biodizela ima i svoje nedostatke koji su riješeni korištenjem unaprijeđenih izvedbi reaktora, kao što su primjerice mikroreaktori, reaktori s oscilatornim protokom ili reaktori s centrifugom, čime se sam proces znatno intenzivira [1].

Mikroreaktori se u posljednjih nekoliko desetljeća sve više koriste kod sinteze različitih produkata koji svoju primjenu pronalaze u kemijskoj, farmaceutskoj i prehrambenoj industriji. Intenzifikacija procesa koji se provode u mikroreaktorima posljedica je učinkovitog prijenosa tvari i topline koji su rezultat velikog omjera površine i volumena mikroreaktora, odnosno njegovih malih dimenzija i s tim povezanim malim otporima prijenosu tvari i topline [2]. Iako je kemijska sinteza biodizela u mikroreaktoru do sada bila predmet brojnih istraživanja, primjena biokatalizatora za provedbu ovog procesa praktički nije opisana u literaturi. U ovom je radu kao katalizator za proizvodnju biodizela korišten enzim lipaza porijeklom iz gljivice *Thermomyces lanuginosus* dok su kao supstrat upotrijebljeni jestivo i otpadno ulje. Kako bi se utvrdio "idealni sustav" za provedbu procesa sinteze biodizela ispitane su različite konfiguracije mikroreaktora. Nadalje, praćeni su i drugi parametri koji utječu na proces proizvodnje biodizela kao što su veličina mikrokanala, vrijeme zadržavanja, temperatura reakcije te porijeklo katalizatora [3].

Reference

- [1] A. Mazubert, J. Aubin, S. Elgue and M. Poux, *Green Process Synth.* **3** (2014) 419-429.
- [2] A. Madhawan, A. Arora, J. Das, A. Kuila and V. Sharma, *Biomass Convers. Biorefin.* **8** (2018) 485-496.
- [3] S. Budžaki, A. Šalić, B. Zelić and M. Tišma, *Chem. Biochem. Eng. Q.* **29** (2015) 329-333.

Volatile organic compounds abatement in metal and ceramic monolith reactors

Uklanjanje hlapivih organskih spojeva u metalnim i keramičkim monolitnim reaktorima

Marina Duplančić, Vesna Tomašić, Zoran Gomzi
Faculty of Chemical Engineering and Technology, University of Zagreb, Croatia

E-mail: marina.duplancic@fkit.hr

Excessive emissions of volatile organic compounds (VOCs) into the environment, which mainly result from different industrial plants and motor vehicles, greatly affect the quality of the air and thus the quality of life. Intensive research with the aim of reducing the concentrations of volatile organic compounds in the atmosphere has been done during last several decades. Recently, research in this area is focused on the application of process intensification methodology, which involves several approaches, such as integration of catalytic and adsorption processes and development and application of structured catalysts, in particular monolithic reactors.

Here we present results of our research related to the development of a metal (Al/Al₂O₃-MnCuO_x) and ceramic (Cordierite-MnCuO_x) monolithic catalyst/reactors used for catalytic oxidation of a representative volatile organic compound. Toluene was chosen as a model component because it is used in various industries and is often emitted in the environment as a result of the production and use of different organic chemicals, solvents, dyes and similar products. The catalytic tests with monolith catalysts/reactors were carried out at different space times, changing the space times by varying the reaction mixture flow rate over constant monolith reactor length.

Comparison of results obtained by the metal monolithic reactor (0.024 g catalytically active component) and ceramic monolithic reactor (0.065 g catalytically active component) at the same reaction conditions (448 K and 92 cm³min⁻¹) has shown the lower conversions of toluene (72.25 % vs. 98.59 %) over metal monolithic reactor. However, after comparison according to the intrinsic activity, metal monolithic reactor outperforms the ceramic one with almost twice the amount of converted toluene *per* gram of deposited catalytically active component *per* hour (1315.55 vs. 662.8 mg of converted toluene *per* g of catalyst *per* hour).

Finally, a one-dimensional (1D) heterogeneous model of the monolith reactor that included the interphase diffusion was proposed and the key parameters of the reactor model were estimated. It was confirmed that the proposed model describes experimental results very well and therefore can be successfully applied to describe catalytic performances of both reactors within the reaction conditions range used in this research.

Acknowledgment: This work was funded by the Croatian Science Foundation through the project „Intensification of photocatalytic and catalytic processes for treatment of waste water and waste gases“, IN-PhotoCat (IP- 2018-01-8669).

***In silico* analysis of herbicides – impact on human health**

***In silico* analiza herbicida – utjecaj na ljudsko zdravlje**

Vesna Pehar,¹ Davor Oršolić,² Višnja Stepanić^{2,3}

¹Croatian Defence Academy „Dr. Franjo Tuđman“, Zagreb, Croatia

²Centre of Research Excellence for Marine Bioprospecting – BioProCro, Ruđer Bošković Institute, Zagreb, Croatia

³Division of Molecular Medicine, Ruđer Bošković Institute, Zagreb, Croatia

E-mail: yesna.pehar34@gmail.com

Herbicides are chemical compounds intended for selective destruction of weeds. However, besides the target, weed toxicity, herbicides may exert various degrees of toxicity to off-target organisms. Revealing their off-target activities are of great interest in human health risk assessment processes since potentially everyone may be exposed to these compounds [1]. Hence, we have explored the collected data set of 509 approved herbicides for uncovering potential harmful effects of herbicides on human health. Experimental data have been gathered from literature and open accessed databases. Molecular descriptors have been computed using appropriate software. The models obtained by using *in silico* approaches revealed links between the toxic effects with the structural and physicochemical properties of specific classes of herbicides. The aim of the research has been to find structure-activity relationships (SAR) rules that would facilitate the synthesis of new herbicides that are less harmful for human health.

References

[1] V. I. Lushchak, T. M. Matviishyn, V. V. Husak, J. M. Storey and K. B. Storey, *EXCLI J.* **17** (2018) 1101-1136.

Alumina production from purified Bayer liquor Proizvodnja glinice iz pročišćene Bayerove otopine

Biljana Milovanović¹, Đurđa Oljača¹, Stefan Pavlović², Gordana Ostojić¹, Zoran Obrenović¹

¹Alumina Ltd., Zvornik, Bosnia & Herzegovina

²University of Belgrade, Institute of Chemistry, Technology, and Metallurgy,
Belgrade, Republic of Serbia

E-mail: biljana.milovanovic@birac.ba

Removal of some impurities from Bayer liquor, such as zinc compounds, allows obtaining alumina with low content of impurities incorporated in the crystalline structure. Impurities in alumina influence the quality of products obtained from alumina during electrolysis. In this research, the purification method presented in our previous paper was used for the purification of Bayer liquor, from which alumina was produced [1]. Crystallization of Bayer liquor was conducted at 52 °C during 24 h, whereas aluminum hydroxide with specific structural properties was used as the seed. The crystallization product (aluminum hydroxide) was calcined at 950 °C for 2 h with the heating rate of 5 °C min⁻¹. The obtained alumina (Alumina I) is compared with alumina obtained without Bayer liquor purification (alumina from bauxite refinery „Alumina“ I.t.d., Zvornik, B&H – Alumina II). Zinc content is determined by atomic absorption spectroscopy. Structural and morphological properties are characterized by XRD, FT-IR, N₂-physisorption, and particle size analyzer. Zinc content as ZnO in the initial and purified Bayer liquor was 0.0494 g dm⁻³ and 0.0057 g dm⁻³, respectively. Alumina from bauxite refinery contains 0.0260% ZnO, whereas the zinc content in alumina obtained after Bayer liquor purification was 0.016% ZnO. XRD analysis (Figure 1) showed that crystal structure is not destroyed and characteristic lines for both samples are at a 2θ angle: 34.2, 37.2, 40.7, and 49.8. Bands characteristic for γ-Al₂O₃ and α-Al₂O₃ in pseudoboehmite structure can be observed at low wavenumbers in the obtained FT-IR spectra [2]. Specific surface area and average pore diameter are shown in Table 1. These values are similar for both alumina samples.

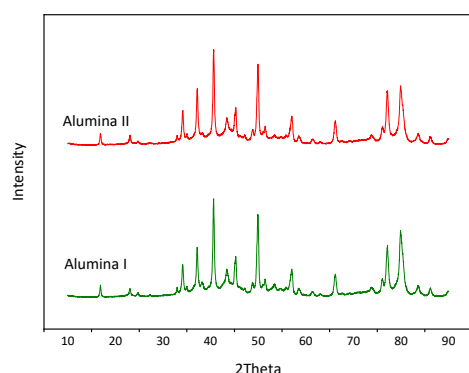

Figure 1: XRD pattern of the produced alumina.

Sample	S _{BET} (m ² /g)	D _{av} (μm)
Alumina I	47.5	4.00
Alumina II	53.8	1.62

References

- [1] Đ. Oljača, B. Milovanović, S. Pavlović, R. Smiljanić, Z. Obrenović and R. Filipović, *Proceedings of the 12th Conference of Chemists, Ecologists and Technologists of the Republic of Srpska*, Faculty of Technology, 2018, Banja Luka, p. 43.
- [2] C. Liu, K. Shih, Y. Gao, F. Li and L. Wei, *J. Soils Sediments* **12** (2012) 724-733.

Effect of organically modified montmorillonite Cloisite 10A and Cloisite 30B on crystallinity and thermal properties of poly(ethylene oxide)
Utjecaj organski modificiranih montmorilonita Cloisite 10A i Cloisite 30B na kristalnost i toplinska svojstva poli(etilen-oksida)

Irena Krešić, Matko Erceg
Kemijsko-tehnološki fakultet, Sveučilište u Splitu, Split, Hrvatska

E-pošta: merceg@ktf-split.hr

U ovom radu provedena je priprema i karakterizacija nanokompozita poli(etilen-oksida) (PEO), $\bar{M}_w = 100000$, i organski modificiranih montmorilonita Cloisite 10A i Cloisite 30B. Uzorci PEO-a s modificiranim montmorilonitima kao nanopunilima pripremljeni su metodom interkalacije iz taljevine. Ispitan je utjecaj dodatka obaju nanopunila na toplinske prijelaze (staklište, talište, kristalište), stupanj kristalnosti i toplinsku postojanost PEO. Toplinski prijelazi i stupanj kristalnosti ispitivani su diferencijalnom pretražnom kalorimetrijom (DSC) dok je toplinska postojanost ispitana dinamičkom termogravimetrijom (TG). Iz DSC-analize vidljivo je da dodatak obaju nanopunila izraženije snižava staklište i talište PEO pri udjelima punila većim od 40 mas. %. Stupanj kristalnosti PEO raste pri udjelima nanopunila do 20 mas. % nakon čega se uočava njegovo smanjenje. Primjena infracrvene spektroskopije s Fourierovom transformacijom (FTIR) ukazuje na narušavanje spiralne konformacije makromolekula PEO dodatkom nanopunila Cloisite 10 A i Cloisite 30B. Temperatura kristalizacije snižava se s povećanjem udjela oba nanopunila, zbog njihova inhibicijskog utjecaja na kristalizaciju PEO. Primjenom TG-analize utvrđen je snažan negativan utjecaj obje vrste nanopunila na toplinsku postojanost PEO. Pri tome je negativan utjecaj dodatka Cloisite 10A znatno izraženiji u odnosu na Cloisite 30B.

Antifungal activity of the extracts of selected marine organisms Antifungalna aktivnost ekstrakata odabranih morskih organizama

Ana-Marija Cikoš,¹ Bojan Šarkanj,¹ Igor Jerković,² Marin Roje,³ Stela Jokić¹

¹Josip Juraj Strossmayer University of Osijek, Faculty of Food Technology Osijek, Osijek, Croatia

²Faculty of Chemistry and Technology, University of Split, Split, Croatia

³Ruđer Bošković Institute, Zagreb, Croatia

E-mail: acikos@ptfos.hr

Marine organisms represent a rich source of bioactive compounds with a high potential in therapeutic and industrial applications. It has been proven that these compounds possess a wide range of bioactivities, such as antioxidant, antimicrobial, antiproliferative and anti-inflammatory.

This study aimed to investigate antifungal activity of the extracts obtained with ultrasound-assisted extraction. Tested marine organisms included tunicate *Aplidium conicum*, green macroalga *Codium bursa*, brown macroalga *Cystoseira* sp. and cnidarian *Eunicella cavolinii* collected from the Adriatic Sea, in April 2018. Ultrasound-assisted extraction was performed at the ultrasound bath for each of mentioned organisms with two different solvents; water was used for the extractions of polar compounds, while dimethylsulfoxide (DMSO) was used for non-polar compounds. The conditions during the extraction were: the temperature of 30 °C and the time of 30 minutes, the concentration in case of *Codium bursa* was 20 mL g⁻¹, while for the other organisms it was 10 mL g⁻¹. The extracts prepared in water and DMSO were tested separately in order to compare their activities depending on the polarity of extracted compounds. The antifungal activity of these extracts was tested against the most common and problematic mycotoxigenic fungi including: *Alternaria alternata*, *Aspergillus flavus*, *Aspergillus ochraceus*, *Fusarium graminearum*, *Fusarium verticillioides* and *Penicillium expansum*. Antifungal testing was performed with standardized microdilution method which is in accordance with the NCCLS guidelines, document M38-A.

The obtained results showed that there is a significant difference in the activity against tested fungal species depending on the used extract (water or DMSO).

Subcritical water extraction of bioactive compounds from tobacco waste Ekstrakcija bioaktivnih komponenti iz duhanskog otpada vodom u subkritičnom stanju

Marija Banožić,¹ Tanja Gagić,² Mojca Škerget,² Stela Jokić¹

¹*Josip Juraj Strossmayer University of Osijek, Faculty of Food Technology Osijek, Osijek, Croatia*

²*University of Maribor, Faculty of Chemistry and Chemical Engineering Maribor, Slovenia*

E-mail: mbanozic@ptfos.hr

Industrial processing of tobacco generates large amounts of waste. Tobacco waste has high nicotine content. It also has a high content of solanesol and is rich in other alkaloids and phenolic compounds. Therefore, final disposal of tobacco waste in the environment is difficult. Re-using in the industry is suggested to limit their harm to the environment. This study evaluated subcritical water extraction (SWE) of bioactive compounds from tobacco waste (scrap, dust and midrib) obtained from tobacco processing factory “Fabrika duhana Sarajevo”. Recently, SWE has become a popular green extraction technique for the extraction of different classes of bioactive compounds from plant materials. The objectives of this work were: (a) to separate valuable compounds from tobacco waste by applying sustainable green separation process—subcritical water extraction (SWE); (b) identification and quantification of active compounds in obtained extracts using HPLC. Depending on applied extraction conditions (extraction temperature, time and solvent/solid ratio), different concentrations of active compounds were determined in the extracts. Contents of those compounds in tobacco waste were compared with starting material (tobacco leaves). Extracts were characterized with high level of nicotine and considerable amounts of nicotinic acid, nicotinamide, 5-(hydroxymethyl)furfural, furfural, 5-methylfurfural, 3,4-dihydroxybenzoic acid, chlorogenic acid and rutin.

Considering these bioactive compounds as tobacco waste ingredients is beneficial due to their biological properties such as antioxidant, anticancer, antifungal and other activity.

Crystallization process development strategy from lab to industrial scale Strategija razvoja procesa kristalizacije s laboratorijskog na industrijsko mjerilo

Matija Galjer, Franjo Jović, Eugen Marčelić, Amir Avdagić
Pliva Croatia, TAPI R&D, Zagreb, Croatia

E-mail: Matija.Galjer@pliva.com

Crystallization is a critical stage in the manufacture of an active pharmaceutical ingredient (API) where key attributes such as purity together with physical and mechanical properties of the crystals are set. The approach in our work is based on increased in-depth knowledge using experimental design, optimal choice of reaction vessel and in-time system monitoring [1]. They offer many advantages and benefits, including precise process control and improving the quality of API as well as the final form of medication.

The temperature profile applied during batch cooling crystallization affects the supersaturation level, which in turn affects the particle size distribution (PSD) [2]. PSD is also dependent on parameters such as: hydrodynamic properties (reactor geometry and added elements, mixing), shape of the metastable zone for certain solvent system, seeding (amount, addition and duration, temperature, PSD of seeds) [3].

In this work, crystallization of an API anhydride in methanol solution was explored. Several operational parameters such as temperature, seeding and hydrodynamics are controlled to achieve constant desupersaturation, consistent narrow particle size distribution around the desired mean, minimal attrition, and homogeneous growth conditions. Linear cooling profile from 60 to 0 °C in 2 h was modified to calculated optimal parabolic profile. The amount of seeds was in range from 0,025% to 2% in proportion to the mass of the API. Simulation tools were used for process modeling and optimization of mixing regimes regarding non-uniformity (<25% axial) and energy dissipation (maximal $\approx 1.5 \text{ W kg}^{-1}$) during the scale-up from laboratory (from 1 to 6 L scale) to pilot scale (100 L scale). The metastable zone has also been determined by using UV/Vis spectroscopy. Using a Focused Beam Reflectance Measurement probe throughout crystallization in-time, PSD and total crystal count have been measured. X-ray Powder Diffraction is used to confirm right crystal polymorph.

The control of PSD has been successfully implemented and desired PSD ($d_{10} > 2 \text{ }\mu\text{m}$, $d_{50} \sim 50 \text{ }\mu\text{m}$, $d_{90} < 180 \text{ }\mu\text{m}$) was achieved. Experiments in pilot plant have yielded similar results. Non-suspended mixing regime generated slightly inferior PSD to PSD of the preferred, suspended regime.

References

- [1] M. R. Abu Bakar, Z. K. Nagy, A. N. Saleemi and C. D. Rielly, *Cryst. Growth Des.* **9** (2009) 1378-1384.
- [2] L. Feng and K. A. Berglund, *Cryst. Growth Des.* **2** (2002) 449-452.
- [3] J. Ulrich and P. Froberg, *Front. Chem. Sci. Eng.* **7** (2013) 1-8.

Crystallization of a pharmaceutical cocrystal by advanced supersaturation control

Kristalizacija farmaceutskog kokristala naprednim vođenjem prezasićenosti

Damir Šahnić,¹ Dejan Kišiček,¹ Hrvoje Dorić,² Ivan Mohler,² Nenad Bolf²

¹PLIVA Croatia Ltd. (member of TEVA group), TAPI Research & Development, Zagreb, Croatia

²University of Zagreb, Faculty of Chemical Engineering and Technology, Zagreb, Croatia

E-mail: damir.sahnic@pliva.com

In situ monitoring and control of crystallization processes is receiving more and more interest in the pharmaceutical and specialty chemicals industries over the past two decades [1-2]. Physical characteristics of APIs such as the polymorphic form, morphology and particle size distribution which are important for subsequent downstream processing are determined by the crystallization process. By manipulating the supersaturation level as the driving force for crystallization, different outcomes with respect to the aforementioned characteristics can be achieved. To that end, robust control strategies of crystallization processes using supersaturation control, achieved by the combined use of Process Analytical Technologies (PATs) and chemometrics can be developed and applied to obtain the desired physical characteristics of APIs [2].

The development of a quantitative in-line ATR-UV/Vis spectroscopic method for solute concentration monitoring during a crystallization process of an API cocrystal is described. The method is comprised of a chemometric PLSR (partial least squares regression) calibration model used for solute concentration calculation from acquired spectra and actual temperatures. The use of this method together with the reactor temperature control achieved by applying feedback supersaturation control (SSC) during the course of a seeded cooling crystallization experiment is also described. Data acquisition for the model development, data preprocessing, model building and SSC was performed with the aid of a proprietary, in-house developed software suite, *CrystCal*. The developed method proved to be a robust and fast way to monitor the solute concentration *in-situ*, thereby enabling the SSC system to cool the crystallization mixture while keeping the supersaturation at a desired level. The developed system can be used for other target supersaturation levels and has a potential for application on other crystallization systems.

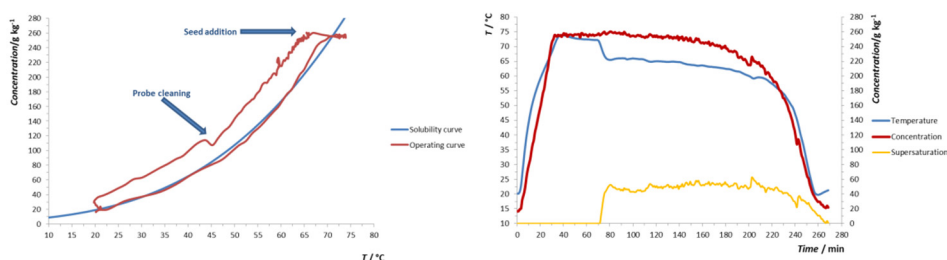

Figure 1: The result of a supersaturation controlled, seeded cooling crystallization experiment.

References

- [1] R. D. Braatz, *Annu. Rev. Control* **26** (2002) 87-99.
- [2] Z. K. Nagy and R. D. Braatz, *Annu. Rev. Chem. Biomol. Eng.* **3** (2012) 55-75.

Post-modified acid-base bifunctional ZIF-8 catalyst for the one-pot deacetalization-Knoevenagel tandem reaction
Post-modificirani bifunkcionalni kiselo bazni katalizator ZIF-8 za tandemsku reakciju deacetalizacije i Knoevenagelove kondenzacije u jednoj posudi

Yu-Ri Lee,¹ Xuan Huy Do,^{1,2} Kyung-Youl Baek^{1,2,3}

¹Materials Architecturing Research Center, Korea Institute of Science and Technology, Seoul, Republic of Korea.

²Division of Nano & Information Technology, KIST School, Korea University of Science and Technology, Seoul, Republic of Korea.

³Center for Convergent Chemical Process, Korea Research Institute of Chemical Technology, Daejeon, Republic of Korea.

E-mail: baek@kist.re.kr

The use of one-pot chemical synthesis processes has been recognized as a promising approach to reduce multi-step purification and improve overall efficiency. Recently, it was reported that zeolitic imidazolate framework ZIF-8 has a variety of active sites including hydroxyl, amine, low-coordinated Zn atoms, and free N moieties belonging to linkers [2], suggesting that ZIF-8 has not only acid sites but also base sites on its structure. We herein reported the synthesis of amine-functionalized ZIF-8 [1], ZIF-8-A with different amine contents from 15 to 61%, by the ligand exchange of 2-methylimidazole with 3-amino-1,2,4-triazole (Atz) *via* post-synthetic modification. In addition, to improve the acidity of the ZIF-8-A material, sulfonic acid group was functionalized on ZIF-8-A61, ZIF-8-A61-SO₃H, by the ring-opening reaction of 1,3-propanesulfone which reacted with amine groups of Atz on ZIF-8-A61. The prepared materials were assessed as a bifunctional acid–base catalyst for a one-pot deacetalization-Knoevenagel tandem reaction of benzaldehyde dimethylacetal and malononitrile under mild reaction conditions. Compared with the homogeneous catalyst and ZIF8-A series, ZIF-8-A61-SO₃H showed superior catalytic activity and selectivity, and was found to be reusable for up to five consecutive runs.

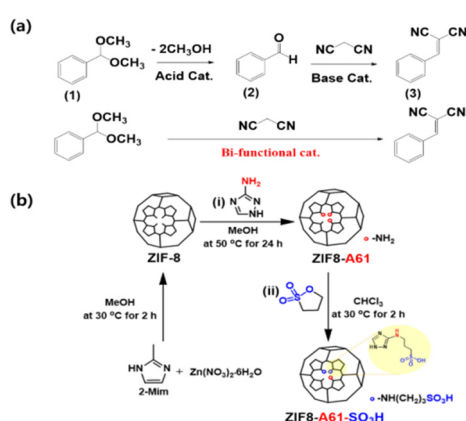

Figure 1: (a) One-pot deacetalization-Knoevenagel tandem reaction and (b) synthesis procedure for (i) amine-functionalized ZIF-8, ZIF8-A61, with 61% of 3-amino-1,2,4-triazole (Atz) conversion and (ii) acid-base bifunctionalized ZIF8-A61-SO₃H by the ring-opening reaction of 1,3-propanesultone performed on ZIF8-A61.

References

[1] K. Y. Cho, H. S. An, X. H. Do, K. S. Choi, H. G. Yoon, H. K. Jeong, J. S. Lee and K. Y. Baek, *J. Mater. Chem. A* **6** (2018) 18912-12919.

Photolytic and photocatalytic degradation of neonicotinoid insecticide imidacloprid Fotolitička i fotokatalitička razgradnja neonicotinoidnog insekticida imidakloprida

Kristina Babić,¹ Ivana Grčić,² Vesna Tomašić,¹ Zoran Gomzi¹

¹Fakultet kemijskog inženjerstva i tehnologije Sveučilišta u Zagrebu, Zagreb, Hrvatska

²Geotehnički fakultet Sveučilišta u Zagrebu, Varaždin, Hrvatska

E-pošta: kbabic@fkit.hr

Proizvodnja i primjena pesticida progresivno raste u posljednjih nekoliko desetljeća. U novije vrijeme raspravlja se o zloupotrebi pesticida i njihovu štetnom djelovanju na ljude, biljni i životinjski svijet te onečišćenju podzemnih voda, što je rezultat česte upotrebe tih kemikalija uz pogrešnu pretpostavku: „ako male koncentracije djeluju, veće će biti još učinkovitije“ [1,2].

Cilj ovog istraživanja je izučavanje fotolitičke i fotokatalitičke razgradnje neonicotinoida imidakloprida (C₉H₁₀ClN₅O₂), koji prema IUPAC-u dolazi pod kemijskim nazivom 1-(6-klor-3-piridinilmetil)-N-nitroimidazolidin-2-ilidenamin (slika 1), a primjenjuje se kao djelatna tvar u brojnim komercijalnim insekticidima (Kohinor, Magnum, Confidor, Gaucho, Macho i dr.) s ciljem sprječavanja, uništavanja ili suzbijanja štetnika u usjevima.

Fotorazgradnja imidakloprida provedena je u pločastom fotoreaktoru dimenzija 19 x 10 x 2,5 cm uz recirkulaciju reakcijske smjese pomoću peristaltičke pumpe (*Masterflex L/S, Cole Parmer*) koja omogućava rad pri protocima od 0,6 do 2900 ml min⁻¹. Za fotoinduciranu razgradnju modelne komponente korištene su dvije UV lampe (*Arcadia Bird Lamp Natural Sun T5; 8 W, 300 x 16 mm, 2,4 % UVB i 10 % UVA*) postavljene na udaljenosti 3 cm od reakcijske smjese. Intenzitet zračenja mjeren je UVX radiometrom (UVP) uz odgovarajuće senzore zavisno o tipu zračenja. Fotokatalitička razgradnja imidakloprida provedena je primjenom komercijalnog TiO₂ fotokatalizatora koji je neposredno prije provođenja fotokatalitičke razgradnje aktiviran na odgovarajući način, a korišten je u suspendiranom i imobiliziranom obliku. Reakcije fotorazgradnje provedene su pri pH 6,5–7, početnoj koncentraciji imidakloprida od 10 ppm te pri različitim protocima recirkulacije i sobnoj temperaturi. Analiza produkata fotolitičke i fotokatalitičke razgradnje provedena je tekućinskom kromatografijom visoke učinkovitosti (HPLC-DAD, *Shimadzu*).

Na temelju provedenih istraživanja predloženi su kinetički model i model reaktora te procijenjeni ključni parametri modela. U završnom dijelu izvedeni su zaključci o mehanizmu i učinkovitosti fotolitičke i fotokatalitičke razgradnje.

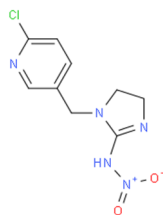

Slika 1: Strukturna formula imidakloprida.

Reference

- [1] T. Tišler, A. Jemec, B. Mozetič i P. Trebše, *Chemosphere* **76** (2009) 907-914.
[2] M. W. Aktar, D. Sengupta i A. Chowdhury, *Interdisc. Toxicol.* **2** (2009) 1-12.

Napomena: Ovaj je rad financirala Hrvatska zaklada za znanost projektom Intenzifikacija fotokatalitičkih i katalitičkih procesa za obradu otpadnih voda i otpadnih plinova, IN-PhotoCat (IP-2018-01-8669).

***Helichrysum italicum* as corrosion inhibitor**

***Helichrysum italicum* kao inhibitor korozije**

Zora Pilić, Ivana Martinović, Gloria Zlatić

Fakultet prirodoslovno-matematičkih i odgojnih znanosti, Sveučilište u Mostaru, BiH

E-pošta: zora.pilic@fpmoz.sum.ba

Velik tehnološki značaj metala i legura povod je iznimnog interesa znanstvenika za istraživanje fenomena pasiviteta i korozije. Pasivitet je povezan sa stvaranjem oksidnog filma na površini, debljine svega nekoliko nm, čije karakteristike presudno utječu na ponašanje tih materijala u korozivnom mediju, te su stabilni oksidni filmovi i odgovarajuća mehanička svojstva osnovni preduvjeti za uspješno korištenje. Kisela kiša jedan je od glavnih čimbenika koji izaziva brzu i intenzivnu koroziju metalnih materijala izloženih atmosferi. Pojavu kiselih kiša uzrokuju emisije otpadnih plinova (CO, CO₂, SO₂, NO_x, SO_x, i čestice prašine) u atmosferu kao posljedica spaljivanja fosilnih goriva. Kiša s pH < 5,6 smatra se kiselom kišom. Primjena inhibitora jedna je od metoda za suzbijanje korozijskih procesa. Kako je velik broj djelotvornih inhibitora štetan, u novije vrijeme ulažu se napor da se isti zamijene prirodnim, ekološki prihvatljivim tvarima. Biljni materijali bogati prirodnim antioksidansima, poput polifenolnih spojeva, pokazuju znatnu inhibiciju korozije, a lako su dostupni, netoksični i biorazgradljivi, te istraživanja autohtonog aromatičnog i ljekovitog bilja kao potencijalnih inhibitora korozije metala i legura postaju sve važnija.

Proces korozije bakra u simuliranoj otopini kisele kiše ispitivan je elektrokemijskim tehnikama uz dodatak vodenog ekstrakta *Helichrysum italicum* (HI) i bez njega. Dobiveni rezultati pokazuju kako biljni ekstrakt (dodan u koncentracijama: 0,01, 0,10, 0,50 i 1,00 g L⁻¹) doprinosi pasivaciji metala smanjenjem anodne gustoće struje uz stvaranje tanjih filmova većeg otpora u odnosu na film formiran u čistom elektrolitu. Otpor filma rastao je od 31 kΩ cm² za otopinu kisele kiše do 47 kΩ cm² pri dodatku ekstrakta koncentracije 1,00 g L⁻¹. Dodatkom ekstrakta HI od najniže do najviše ispitivane koncentracije povećava se učinkovitost inhibicije u rasponu od oko 10 % do 35 %. Analiza potenciodinamičkih polarizacijskih krivulja ukazuje kako je inhibicija korozije u ispitivanom sustavu posljedica blokiranja aktivnih mjesta na metalnoj površini što dovodi do promjene aktivacijske barijere. Istraživanjem utjecaja temperature u rasponu od 15 do 35 °C uz pomoć Arrheniusove jednadžbe utvrđeno je kako se energija aktivacije povećava od 40 kJ mol⁻¹ za otopinu čiste kisele kiše do 48 kJ mol⁻¹ pri dodatku ekstrakta koncentracije 1,00 g L⁻¹. Adsorpcija ekstrakta na površini metala odgovara fizisorpciji ($\Delta G = \sim 15 \text{ kJ mol}^{-1}$) i slijedi Freundlichovu izotermu. Koncentracija iona bakra u otopini, mjerena atomskom apsorpcijskom spektrometrijom, u skladu je s elektrokemijskim rezultatima, pri čemu je izmjerena koncentracija iona u otopini kisele kiše iznosila 357 μg L⁻¹cm⁻², a pri dodatku ekstrakta koncentracije 1,00 g L⁻¹ iznosila je 135 μg L⁻¹cm⁻².

Modelling reactive dye removal by ultrafiltration ceramic membranes Modeliranje separacije reaktivnog bojila primjenom ultrafiltracijske keramičke membrane

Viola Somogyi,¹ Maja Zebić Avdičević,² Réka H. Hargitai,¹ Endre Domokos,¹ Davor Ljubas,²
Slaven Dobrović²

¹University of Pannonia, Institute of Environmental Engineering, Veszprém, Hungary

²University of Zagreb, Faculty of Mechanical Engineering and Naval Architecture, Department of Energy, Power Engineering and Environment, Chair of Water and Environmental Engineering, Zagreb, Croatia

E-mail: hargitai.reka@mk.uni-pannon.hu

Textile industry effluents pose environmental risks due to the persistence of the additives and dye residues but membrane technology can effectively remove these contaminants. Since membranes, especially ceramic membranes are prone to fouling, which results in reduced membrane performance and increased operational costs, pretreatment may be necessary.

Wastewater containing reactive dye (Novacron Orange) was treated with a 1 kDa tubular multichannel ceramic membrane. Several versions of pretreatment solutions were experimented with, including filtration with submerged polyethylene (PE) hollow fiber membrane combined with different concentrations of magnesium chloride as coagulant to test the optimal efficiency. The rate of pollutant removal was characterized with the decrease in total organic carbon (TOC) concentration and color intensity reduction.

Modelling removal performance may assist the technology to predict fouling and necessary cleaning frequency. A membrane separation model was developed earlier by the research group to simulate filtration efficiency by combining a fouling model including pore blockage, pore constriction and cake layer formation with a modified Spiegler-Kedem-Katchalsky model for ultrafiltration to assess the permeate concentration as a function of the change in permeate flow rate. Experimental data from the treatment of the reactive dye wastewater were fed to the model to test its validity under different conditions. Parameters that are sensitive to the different types of pretreatment (membrane filtration and coagulation) were identified and comparative analysis of the results was carried out to evaluate the robustness of the model and to provide a clear understanding of membrane separation mechanisms regarding reactive dye removal from textile wastewater.

Ultrafiltration of textile mercerization wastewater using ceramic membranes – modelling fouling and performance

Ultrafiltracija otpadne vode iz procesa mercerizacije tekstila keramičkim membranama – ispitivanje radnih karakteristika i modela blokiranja pora

Maja Zebić Avdičević,¹ Viola Somogyi,² Davor Ljubas,¹ Endre Domokos,² Slaven Dobrović,²
Réka H. Hargitai,² Béla Varga²

¹University of Zagreb, Faculty of Mechanical Engineering and Naval Architecture, Department of Energy, Power Engineering and Environment, Chair of Water and Environmental Engineering, Zagreb, Croatia

²University of Pannonia, Faculty of Engineering, Institute of Environmental Engineering, Veszprem, Hungary

E-mail: vargabela@almos.uni-pannon.hu

Textile industry is rated as the most polluting sector though there are serious efforts to mitigate the environmental effects. Mercerization is the first stage of textile treatment: highly caustic alkaline solution of sodium hydroxide and auxiliary chemicals are used at high temperature to improve the textile fibre strength and dye efficiency by rearranging the cellulose molecules in the fibres.

With ultrafiltration (UF) separation processes suspended solids can be removed from wastewater generated after rinsing the treated cotton and the alkaline solution of surfactants may be reused. Since wastewater from mercerization process has high temperature and is extremely alkaline, ceramic membranes could be appropriate choice for its treatment.

Experiments were carried out on laboratory cross flow membrane set-up using mercerization wastewater without any changes or additions. Laboratory filtration experiments were conducted with two ceramic membranes 1 and 500 kDa in cross-flow filtration mode with complete retentate recycling at the cross-flow velocity (CFV) of 1 – 3 m s⁻¹. During separation tests, permeate flux decline and transmembrane pressures (TMP) were measured and these results were used to investigate the fouling mechanisms. The membrane performances were measured in terms of parameters such as pH, alkalinity, conductivity, total suspended solids (TSS), turbidity, and total organic carbon (TOC).

Hermia has developed four empirical models that correspond to four basic types of fouling: complete blocking, intermediate blocking, standard blocking and cake layer formation. In this work Hermia's models are used to investigate the fouling mechanisms involved in crossflow ultrafiltration using tubular multichannel ceramic membranes of 1 and 500 kDa MWCO. For the smaller MWCO the main drive for fouling was found to be intermediate blocking while for the larger pore size clogging appeared mostly due to gel layer formation.

A two-step method for purification of waste tyre pyrolysis oil Dvostupnjevita metoda pročišćavanja pirolitičkog ulja iz otpadnih guma

Tina Posedi,¹ Maja Fabulić Ruszkowski,² Aleksandra Sander,¹ Dijana Blažek,³
Iva Sanja Beer Romac³

¹Fakultet kemijskog inženjerstva i tehnologije Sveučilišta u Zagrebu, Zagreb, Hrvatska

²INA, Razvoj rafinerija i marketinga, Napredne tehnologije i razvoj proizvoda, Zagreb, Hrvatska

³INA, Razvoj rafinerija i marketinga, Centralni ispitni laboratorij, Zagreb, Hrvatska

E-pošta: tposedi@fkit.hr

Revidirana Direktiva o obnovljivim izvorima energije (eng. *Renewable Energy Directive*), tzv. RED 2 Direktiva 2018/2001 jedna je od ključnih direktiva iz paketa Čiste energije. Direktiva je u RH stupila na snagu 24. 12. 2018. s obvezujućim ciljem korištenja minimalno 32 % energije iz obnovljivih izvora u 2030.

S obzirom na visoko postavljene ciljeve, naftna industrija primorana je tražiti nove oblike obnovljivih izvora energije, poput goriva dobivenih porijeklom iz nebioloških materijala ili otpada koja bi se mogla dodavati u fosilna motorna goriva u malim udjelima. U tu svrhu započeta su istraživanja vezana uz mogućnost primjene pirolitičkih ulja dobivenih iz otpadnih guma koje karakterizira niz nepoželjnih karakteristika kao što su visok sadržaj sumpora, dušika, klora, čađe te visok kiselinski broj.

U svrhu reduciranja nepoželjnih karakteristika proveden je postupak koji je uključivao kombinaciju ekstrakcije niskotemperaturnim eutektičnim otapalima i adsorpcije. Ekstrakcija je provedena u svrhu smanjenja sadržaja dušika, klora i kiselinskog broja pri blagim reakcijskim uvjetima s različitim omjerima otapala i ispitivanog medija. Uklanjanje sumpora uključivalo je dvostupanjski postupak uz korištenje sulfatne kiseline i različitih adsorbensa. Definirani su optimalni uvjeti za oba postupka.

Tretirano pirolitičko ulje namiješano je u malom postotku u motorna goriva te su dobiveni zadovoljavajući rezultati. Dobiveni rezultati poslužit će u daljnjem ispitivanju s ciljem povećanja korištenja obnovljivih goriva iz otpada te smanjenja emisija stakleničkih plinova u naftnoj industriji.

Selection of the appropriate solvent and crystallization type for the active pharmaceutical ingredient fosamprenavir calcium Odabir odgovarajućeg otapala i tipa kristalizacije za djelatnu farmaceutsku tvar fosamprenavir-kalcij

Hrvoje Dorić, Luka Đuran, Ivan Vrban, Nenad Bolf, Jasna Prlić Kardum
Fakultet kemijskog inženjerstva i tehnologije Sveučilišta u Zagrebu, Zagreb, Hrvatska

E-pošta: hdoric@fkit.hr

Fosamprenavir-kalcij koristi se u liječenju HIV-a, a djeluje kao prolijek amprenavira. Metaboličkim djelovanjem u ljudskom tijelu iz fosamprenavira nastaje amprenavir koji služi kao inhibitor proteaze humanog virusa imunodeficiencije (HIV) s antivirusnim djelovanjem. Lijek se primjenjuje u tom obliku jer se tako sporije oslobađa u ljudskom tijelu te je njegovo djelovanje produljeno. Molekula fosamprenavir-kalcija može postojati u različitim kristalnim i amornim oblicima ovisno o načinu pripreme što je opisano u više patenata. U ovom istraživanju koristio se kristalni oblik 1.

Odabir otapala za provedbu rekristalizacije proveden je pomoću uređaja Crystal16. Cilj je bio odrediti otapalo koje pokazuje zadovoljavajuću ovisnost koncentracije otopljene tvari o temperaturi sustava. Voda, izopropanol, aceton, acetonitril, etanol gotovo ne otapaju ispitivanu djelatnu tvar (manje od 1 %) niti pri povišenim temperaturama, dok se u metanolu topljivost povećava s povišenjem temperature (pri $T = 35\text{ °C}$ $X_s > 150\text{ mg ml}^{-1}$). Za metanol i mješavinu metanola i vode (19:1) određene su širine metastabilne zone. Dodatak vode znatno povećava širinu metastabilne zone od 15 °C , koliko iznosi za čisti metanol, na 25 °C . Kristalizacija hlađenjem provedena je za sustav fosamprenavir-kalcij – metanol, dok je kristalizacija precipitacijom provedena za sustav fosamprenavir-kalcij – metanol uz dodatak vode i etanola kao antiotapala. Rezultati različitih načina provođenja kristalizacije prikazani su kroz usporedbu XRD-snimaka, mikroskopskih slika kristala i raspodjele veličina dobivenih kristala.

Istraživanje je provedeno kao preliminarno ispitivanje sustava koji će se primijeniti u daljnjem radu, koji se odnosi na mogućnost *on-line* praćenja raspodjele veličine kristala u procesu kristalizacije. Krajnji cilj istraživanja je razvoj napredne metode za vođenje procesa kristalizacije koja bi osiguravala željenu raspodjelu veličina kristala na kraju procesa.

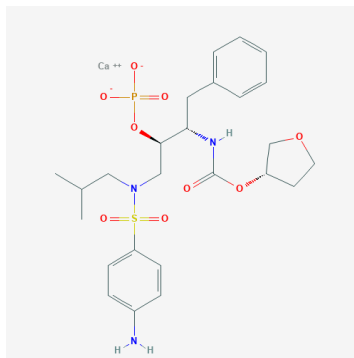

Slika 1: Molekula fosamprenavir-kalcija.

Influence of damp heat test on kinetics of the isothermal degradation of polymers

Utjecaj ubrzanog starenja na kinetiku izotermne razgradnje polimera

Matko Erceg, Kristina Knezović

Kemijско-tehnološki fakultet, Sveučilište u Splitu, Split, Hrvatska

E-pošta: kk907@ktf-split.hr

U ovom radu provedena je izotermna toplinska razgradnja dva polimerna materijala koji su bili izloženi ubrzanom starenju (engl. *damp heat test*) u trajanju od 1000 sati i 2000 sati. U svrhu usporedbe, izotermno su razgrađeni i uzorci polimernih materijala koji nisu bili izloženi ubrzanom starenju. Izotermna razgradnja je provedena koristeći *Pyris 1 TGA* u atmosferi dušika. Početna temperatura svih mjerenja bila je 50 °C. Prvi polimer izotermno je razgrađivan pri temperaturama 400 °C, 405 °C, 410 °C i 415 °C, a drugi pri temperaturama 430 °C, 435 °C, 440 °C i 445 °C. Brzina zagrijavanja od početne temperature do temperature izotermne razgradnje iznosila je 20 °C min⁻¹ za sve ispitivane uzorke. Podatci dobiveni izotermnom razgradnjom uporabljeni su za provedbu kinetičke analize. Kinetička analiza provedena je primjenom programa *Netzsch Thermokinetics Professional*. U prvom koraku primijenjena je Friedmanova izokonverzijska metoda uključena u program *Netzsch Thermokinetics Professional* kojoj je cilj utvrditi radi li se o kinetički jednostavnom ili kinetički složenom razgradnom procesu. Utvrđeno je da je toplinska razgradnja ovih polimera s kinetičkog stajališta složen, višestupanjski proces. Primjenom nelinearne regresijske analize izračunati su kinetički modeli koji najbolje opisuju složeni proces izotermne razgradnje ispitivanih polimernih materijala. Zaključeno je da ubrzano starenje utječe na kinetiku izotermne razgradnje ispitivanih polimernih materijala.

The human and *Chlamydomonas reinhardtii* alpha class-like glutathione transferases as tools for designing tailor-made protein nanostructures
Glutation-transferaze slične klasi alfa, humane odnosno iz alge *Chlamydomonas reinhardtii*, kao alati za krojenje proteinskih nanostruktura

Evi Chronopoulou,¹ Marianna Chatzikonstantinou,¹ Panos Madesis,² Nikos E. Labrou¹

¹Laboratory of Enzyme Technology, Department of Biotechnology,
Agricultural University of Athens, Athens, Greece.

²Institute of Applied Biosciences, CERTH, Thessaloniki, Greece

E-mail: lambrou@aua.gr

Understanding the genetic and molecular basis of the cellular detoxifying mechanism is an important goal towards the development of new enzymes with applications in pharmaceutical and cosmetics industries [1]. Glutathione transferases (GSTs, EC 2.5.1.18) are phase II metabolic enzymes that play important role in the detoxification of xenobiotic compounds. A genome survey of *Chlamydomonas reinhardtii* revealed the presence of fifteen GST-like isoenzymes (CrGSTs). A phylogenetic analysis was performed in an effort to examine the genetic relationships amongst CrGSTs and to further classify them within the GST superfamily classes. The phylogenetic reconstruction [2] showed the evolutionary distance relation between the classes alpha, pi, mu and sigma, which were clearly separated in one monophyletic branch. The same branch contains six entries. Among them, the CrGST2, CrGST6 and CrGST15 are closely related to the alpha class GST enzymes, which are found in vertebrates. GST enzymes that belong to the alpha class were the oldest members of this clade. The alpha class GSTs are considered as good model systems for engineering studies, due to their modular catalytic and binding features. The design of supramolecular GST architectures on molecular level (so called “bottom-up” fabrication) can be considered effective for the development of assembled structures, with customized characteristics with applications in pharmaceutical and cosmetic industries. The engineering and design of nanostructures was based on the alpha class GST-fold and was carried out by ‘lego’ chemistry, aiming at the design and development of novel protein folds that can be self-assembled into complex-structures. Surprisingly and in contrast with the complex topology of the globular GST enzymes, a motif with regularized interactions was found. Amino acid residues were selected as potential hot-spots for step-by-step site-directed mutagenesis. The results showed that the mutant and “lego” enzymes appear to exhibit improved catalytic efficiency without losing their structural stability. The discovery and characterization of these mutants depicts the potential of GSTs to be explored for the generation of complex architectures through protein engineering or by inserting specific repeat motifs. Therefore, it is a new strategy for expanding the natural library of GST scaffolds for advanced applications in pharmaceutical and cosmetics industries.

References

- [1] F. Perperopoulou, F. Pouliou and N. E. Labrou. *Crit. Rev. Biotechnol.* **38** (2018) 511-528.
[2] H. Garcia-Seisdedos, C. Empereur-Mot, N. Elad and E. D. Levy, *Nature* **548** (2017) 244-247.

Acknowledgment: We acknowledge financial support from H2020-MSCA-RISE-17 (Project No 778263) and from IKY Scholarship Program: Strengthening PostDoctoral Research, co-funded by the European Social Fund – ESF and the Greek government.

**POSTERSKA PRIOPĆENJA
MATERIJALI**

***POSTER PRESENTATIONS
MATERIALS***

Photocatalytic removal of bisphenol A by composite catalyst based on conductive polymer PEDOT Fotokatalitičko uklanjanje bisfenola A kompozitnim katalizatorom na bazi elektrovodljivog polimera PEDOT

Zvonimir Katančić, Mihovil Turniški, Hrvoje Kušić, Zlata Hrnjak-Murčić
Sveučilište u Zagrebu, Fakultet kemijskog inženjerstva i tehnologije, Zagreb, Hrvatska

E-pošta: katancic@fkit.hr

Otpadne vode ekološki su problem jer su vrlo često opterećene nepoželjnim, često i toksičnim organskim spojevima. Zbog toga ih je prije ispuštanja u okoliš potrebno obraditi različitim metodama. U današnje se doba sve više uz klasične mehaničke, fizikalne i biološke metode koriste napredni oksidacijski procesi. Fotokataliza, jedan od naprednih oksidacijskih procesa, zasniva se na razgradnji onečišćavala uz prisutnost katalizatora čije djelovanje aktivira svjetlost.

Kao najčešći fotokatalizator koristi se metalni poluvodič titanijev dioksid (TiO_2). Zbog velike energije zabranjene zone TiO_2 je aktivan samo pod UV svjetlom pa su u radu sintetizirani kompozitni fotokatalizatori na bazi elektrovodljivog polimera poli(3,4-etilendioksitofen) (PEDOT) koji zbog male energije zabranjene zone apsorbira vidljivo zračenje, te proširuje aktivnost TiO_2 u vidljivi dio spektra. Kemijskom polimerizacijom sintetizirani su kompozitni fotokatalizatori PEDOT-a i TiO_2 uz oksidanse željezov(III)klorid i amonijev persulfat (APS), te različite početne molarne udjele monomera EDOT-a od 2, 6 i 10 %.

Karakterizirani su infracrvenom spektroskopijom, termogravimetrijskom analizom, pretražnom i transmisijom elektronskom mikroskopijom, difuznom reflektancijskom spektroskopijom i plinskom adsorpcijsko-desorpcijskom analizom. Fotokatalitička aktivnost ispitana je praćenjem razgradnje modelnog onečišćivala bisfenola A (BPA) pod simuliranim Sunčevim zračenjem na tekućinskoj kromatografiji visoke učinkovitosti. U svrhu optimiranja uvjeta fotokatalize i pronalaska optimalnog pH, udjela PEDOT-a i koncentracije fotokatalizatora osmišljen je Box-Behnkenov plan eksperimenta.

Rezultati su pokazali da je površina TiO_2 jednoliko prekrivena slojem PEDOT-a debljine 5 do 10 nm te da se sintetiziranim fotokatalizatorima pod simuliranim Sunčevim zračenjem može ukloniti preko 50 % BPA u 60 minuta.

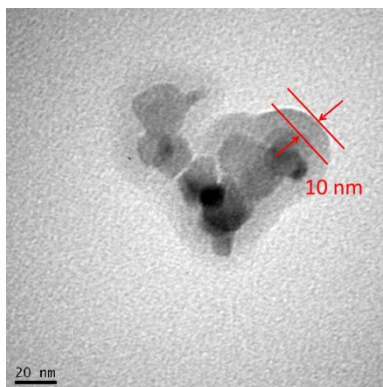

Slika 1: TEM snimka čestice TiO_2 prekrivene slojem PEDOT elektrovodljivog polimera.

Mechanochemical synthesis of cadmium doped ZnO nanoparticles Mehanokemijska sinteza nanočestica ZnO dopiranoga kadmijem

Katarina Mužina, Ivana Katarina Munda, Vilko Mandić, Stanislav Kurajica
Sveučilište u Zagrebu, Fakultet kemijskog inženjerstva i tehnologije, Zagreb, Hrvatska

E-pošta: kmuzina@fkit.hr

Cinkov oksid (ZnO) jedan je od najznačajnijih spojeva cinka, poluvodič koji svoju primjenu nalazi u raznim granama industrije zbog dobrih električnih i mehaničkih svojstava te termičke stabilnosti. Primjenu ZnO kao fotokatalizatora otežava velika energija zabranjene zone (3,7 eV) i brza rekombinacija elektrona i šupljina. Dodatkom dopanata može se smanjiti energija zabranjene zone cinkova oksida i ograničiti proces rekombinacije te tako povećati njegova fotokatalitička aktivnost. Jedan od dopanata koji se u tu svrhu koristi je kadmij. ZnO dopiran kadmijem moguće je pripremiti različitim metodama poput sinteze sagorijevanjem, termolize, koprecipitacije, sonokemijske sinteze, hidrotermalne sinteze, sol-gel procesa itd. Neke od navedenih metoda su kompleksne, teško ih je kontrolirati, zahtijevaju skupu opremu ili prekursore, neprikladne su za sintezu nanočestica ili dovode do visokog stupnja aglomeracije produkta. Mehanokemijska sinteza je jednostavna, ekološki i ekonomski prihvatljiva metoda dobivanja nanočestica koja omogućava dobivanje velike količine produkta.

U ovom radu mehanokemijskom sintezom pripravljene su nanočestice cinkova oksida dopiranoga kadmijem u različitim udjelima. Kao prekursori korišteni su ZnCl_2 , CdCl_2 i Na_2CO_3 , dok je NaCl upotrijebljen kao razrjeđivač. Uzorci su termički obrađeni pri $600\text{ }^\circ\text{C}$ u trajanju od 2 sata, isprani, te analizirani rendgenskom difrakcijom praha (XRD), infracrvenom spektroskopijom s Fourierovom transformacijom (FTIR), UV-Vis difuznom refleksijskom spektroskopijom (DRS), elektronskim pretražnim mikroskopom (SEM), energetske razlučujućom rendgenskom spektroskopijom (EDS) i adsorpcijom N_2 . Fotokatalitička aktivnost pripremljenih katalizatora vrednovana je u procesu razgradnje metilenskog plavila. Utvrđeno je da je mehanokemijskom sintezom moguće ugraditi do 2 mol. % kadmija u kristalnu rešetku cinkova oksida, dok veći udjeli rezultiraju pojavom drugih faza poput kadmijeva oksida i kadmijeva karbonata. Dopiranje utječe na povećanje kristalita ZnO, no veće promjene u morfologiji, energiji zabranjene zone, a sukladno tome i fotokatalitičkoj aktivnosti ZnO nisu uočene.

Influence of chemical treatment of wood wool on wood-cement composite flammability

Utjecaj kemijske obrade drvene vune na zapaljivost drvo-cementnog kompozita

Filip Brleković, Valentina Dragčević, Juraj Šipušić
Sveučilište u Zagrebu, Fakultet kemijskog inženjerstva i tehnologije, Zagreb, Hrvatska

E-pošta: fbrlekovi@fkit.hr

Drvo i cement vrijedni su i kvalitetni građevni materijali dokazani u praksi. Posebice zanimljiva mehanička, termoizolacijska i akustična svojstva posjeduje drvo-cementni kompozit pripremljen od tzv. drvene vune i cementa. Ovisno o dimenzijama drvene vune, te omjeru drvene vune i cementa moguće je pripremiti kompozit različite poroznosti i raspodjele veličina makropora. Ponašanje drvo-cementnog kompozita u požaru jedno je od odlučujućih svojstava koje se mora provjeriti na standardom propisan način. Osim količine dima i energije kojom drvo-cementni kompozit doprinosi požaru, presudno je i svojstvo tinjanja, odnosno polaganog gorenja bez prisutnosti vidljivog plamena. Budući da je tinjanje drvene vune/kompozita potencijalni izvor novog požara, vrlo je nepoželjno te ograničeno standardom propisanim ispitivanjem. Kako bi se i dalje mogao primjenjivati kao građevni materijal, potrebno je unaprijediti svojstva drvo-cementnog kompozita kako bi se požarna svojstva (količina dima, energija gorenja i tinjanje) što više smanjila. Drvo se od požara štiti organskim ili anorganskim spojevima (tzv. usporivači gorenja), no mehanizam njihova djelovanja je različit. Zbog mogućeg nepovoljnog djelovanja složenih organskih spojeva na vezanje i očvršćivanje cementa tijekom pripreme kompozita, prednost je dana anorganskim usporivačima gorenja. U ovom je radu ispitan utjecaj vrste i načina nanošenja tankog sloja anorganskog materijala na drvenu vunu na konačnu zapaljivost kemijski obrađene drvene vune. Uzorci drvene vune duljine 10 cm prvo su impregnirani otopinom aluminijeva sulfata-18-hidrata, nakon čega je dodana otopina amonijeva hidrogenfosfata kojom je izazvano taloženje aluminijeva fosfata unutar i na površini drvene vune. Uzorci su osušeni, a ciklus taloženja je proveden još jednom kako bi se usporedio utjecaj jednostruke i dvostruke impregnacije na zapaljivost kemijski obrađene drvene vune. Postupci ponavljani u jednom ili dva ciklusa trajali su približno 5 minuta. Ispitivanja gorivosti provedena su u aparaturi prilagođenoj drvenoj vuni i laboratorijskim uvjetima. Prilikom ispitivanja korišteni su termoparovi za mjerenje temperatura koje se postižu prilikom gorenja; uzorci su vagani prije i nakon gorenja te analizirani optičkim, stereo i pretražnim elektronskim mikroskopom. U laboratorijskom kalorimetru provedeno je ispitivanje utjecaja uporabljenih kemikalija na hidrataciju cementa. Provedene su i rendgenska difrakcijska analiza (XRD) te analiza infracrvenom spektroskopijom s Fourierovom transformacijom (FTIR) pojedinih uzoraka kako bi se utvrdio sastav bijelog anorganskog taloga. Najbolje rezultate dali su uzorci koji su tretirani 5%-tnim otopinama u dva ciklusa impregnacije.

Stability determination of concentrated alumina suspensions which contain waste alumina powder

Određivanje stabilnosti koncentriranih suspenzija aluminijeva oksida koje sadrže otpadni prah aluminijeva oksida

Milan Vukšić,¹ Irena Žmak,² Lidija Ćurković,¹ Andraž Kocjan,² Petra Jenuš²

¹*University of Zagreb, Faculty of Mechanical Engineering and Naval Architecture, Zagreb, Croatia*

²*Jožef Stefan Institute, Department of Nanostructured Materials, Ljubljana, Slovenia*

E-mail: petra.jenus@ijs.si

This paper reports the results of studying the alumina ceramics which contain a considerable amount of waste alumina powder. During the green machining of the green body, a certain amount of waste ceramic powder is generated which remains unused. In addition, the waste ceramic powder should be disposed of as a non-hazardous waste in a legally prescribed manner. In this paper the influence of Tiron dispersant on the stability of highly concentrated alumina ($\text{Al}_2\text{O}_3 - \text{Al}_2\text{O}_3$ (waste)) suspensions was investigated. The suspension stability of alumina particles has been investigated by measuring the viscosity and the zeta potential. Alumina particles were found to be optimally dispersed at pH between 8 and 10 with the dispersant Tiron. According to the conducted measurements, the investigated composition of waste alumina powder of 20 wt.% expressed on dry weight basis of alumina powders, with the addition of optimal amounts of additives, indicates possible application in the production of ceramics products by slip casting.

Acknowledgment: This work has been fully supported by Croatian Science Foundation under the project IP-2016-06-6000: "Monolithic and composite advanced ceramics for wear and corrosion protection" (WECOR) and Croatian-Slovenian bilateral project "Properties of monolithic and composite advanced ceramics obtained by conventional and non-conventional sintering methods".

Application and influence of microwaves on immobilization of TiO₂ photocatalyst on a carrier

Primjena i utjecaj mikrovalova na imobilizaciju fotokatalizatora TiO₂ na nosač

Igor Jaičinović,¹ Ivan Brnardić,¹ Ivana Grčić,² Kristina Tolić³

¹Sveučilište u Zagrebu, Metalurški fakultet, Sisak, Hrvatska

²Sveučilište u Zagrebu, Geotehnički fakultet, Varaždin, Hrvatska

³Sveučilište u Zagrebu, Fakultet kemijskog inženjerstva i tehnologije, Zagreb, Hrvatska

E-pošta: jajcinovic@simet.hr

Zaštita voda, njihovo pročišćavanje i priprema za ljudsku uporabu jedna je od najvažnijih tema zaštite okoliša. U današnje vrijeme, mikroonečišćenja u vodi, npr. farmaceutici, jedan su od najvećih problema s kojim se susreće znanstvena zajednica [1]. Utvrđivanje njihove prisutnosti nije samo posljedica razvoja analitičkih metoda nego i masovne uporabe farmaceutika kao jednog od najznačajnijeg oblika mikroonečišćenja [2]. Znanstvena istraživanja iz ovog područja usmjerena su u pronalazak novih metoda pročišćavanja voda, a primjer takvog procesa je fotokataliza kod koje dolazi do potpune razgradnje farmaceutika odnosno nastajanja neopasnih razgradnih produkata. U tu svrhu koriste se fotokatalizatori kao što je titanijev dioksid (TiO₂) koji se može primjenjivati u suspendiranom obliku što iziskuje dodatne troškove zbog separacije i posebne oblike reaktora. Ideja o imobilizaciji fotokatalizatora na inertni nosač privukla je pažnju zbog mogućnosti smanjenja troškova u separacijskim procesima nakon fotokatalize [3].

U ovom radu pripremljeni su i karakterizirani napredni fotokatalizatori, imobilizacijom TiO₂ na nosač sol-gel postupkom uz primjenu dva različita načina sušenja, klasičnoga i mikrovalnoga s različitim snagama mikrovalova od 180 do 900 W. Provedena je usporedba dobivenih fotokatalizatora kroz količinu vezanog TiO₂, morfologiju te razine fotokatalitičke aktivnosti. Katalizatori su karakterizirani pretražnom elektronskom mikroskopijom (SEM), energijsko disperzivnom rendgenskom spektroskopijom (EDS) i rendgenskom difrakcijskom analizom (XRD). Aktivnost fotokatalizatora ispitana je kroz sposobnost fotokatalitičke razgradnje salicilne kiseline (SA) u pilotnom reaktoru, praćene UV-VIS spektrometrom.

Reference

- [1] N. Khalid, A. Majid, M. Bilal Tahir, N. A. Niaz i S. Khalid, *Ceram. Int.* **43** (2017) 14552-14571.
- [2] Y. Luo, W. Guo, H. H. Ngo, L. D. Nghiem, I. F. Hai, J. Zhang, S. Liang i X. C. Wang, *Sci. Total Environ.* **474** (2014) 619-641.
- [3] B. Plavac, I. Grčić, I. Brnardić, V. Grozdanić i S. Papić, *React. Kinet. Mech. Cat.* **120** (2017) 385-401.

Modeling and testing of antimicrobial polymers Modeliranje i ispitivanje antimikrobnih polimera

Iva Rezić,¹ Maja Somogyi Škoc,¹ Lela Pintarić,¹ Vanja Ljoljić Bilić,² Ivan Kosalec²

¹Sveučilište u Zagrebu, Tekstilno-tehnološki fakultet, Zagreb, Hrvatska

²Sveučilište u Zagrebu, Farmaceutsko-biokemijski fakultet, Zagreb, Hrvatska

E-pošta: iva.rezic@ttf.hr

U razvoju novih materijala, kao i pri funkcionalizaciji ili modifikaciji postojećih, vrlo značajnu ulogu imaju metode statističke obrade podataka te matematičko modeliranje ponašanja kompleksnih sustava. U ovom će radu biti prikazani postupci modeliranja i optimiranja razvoja antimikrobnih polimera čija je namjena prevencija i liječenje kroničnih rana medicinskim tekstilom s antimikrobno aktivnim nanočesticama. Kronične rane javljaju se kod dijabetičara, pacijenata s opeklinama te ljudi s dekubitusima, pa je poseban fokus ovog istraživanja suzbijanje bakterijskih infekcija na koje ne djeluju antibiotici.

Klasične metode primjene antibiotika u liječenju i prevenciji kroničnih rana nailaze na velike probleme jer mikroorganizmi postaju otporni i praktički neuništivi uobičajenim antibiotskim tretmanima. Vrlo često infekcije takozvanim „zlatnim bakterijama“ završavaju fatalno te imaju ogromne štetne posljedice na ljudsko zdravlje, a postoji korelacija duljine boravka pacijenata u bolnici s infekcijama štetnim mikroorganizmima. Ovaj rad stoga prikazuje primjer uporabe matematičkih modela u razvoju antimikrobnih polimernih celuloznih materijala optimiranih s obzirom na njihova antimikrobna i uporabna svojstva, a prikazane su i metode ispitivanja funkcionaliziranih polimera (koje obuhvaćaju određivanje veličine nanočestica uređajem Nanoparticle Tracking Analyzer, pretražnim elektronskim mikroskopom s EDX detektorom te FTIR spektroskopijom). Optimirani sol-gel proces modifikacije polimera nanočesticama koje su aktivne u suzbijanju infekcija višestruko rezistentnih bakterija obuhvaća šest ulaznih parametara, a rezultat modeliranja i optimiranja je razvijeni novi materijal visoke fleksibilnosti sa slojem smjese nanočestica izuzetno aktivnih antimikrobnih svojstava.

Electrodeposition of MnO₂/graphene/nickel foam composite electrodes for supercapacitors

Elektrodepozicija pjenastih kompozitnih elektroda za superkondenzatore na osnovi MnO₂, grafena i nikla

Yu-Han Chu, Wein-Duo Yang

Department of Chemical and Materials Engineering, National Kaohsiung University of Science and Technology, Kaohsiung, Taiwan

E-mail: ywd@nkust.edu.tw

Graphene was prepared at different voltages firstly, and the nickel foam was immersed in graphene to prepare graphene/nickel foam composite material. The results of the study showed that the higher voltage has the lower electrochemical exfoliation effect, the sulfate ions were electrolyzed and hard to diffuse into the interlayers of graphite effectively. MnO₂ electrode was prepared by constant current deposition at different current density. The results of cyclic voltammetry showed that at the smaller current density MnO₂ develops nanostructure, which increases the capacitance because of the larger contact area between MnO₂ and electrolyte [1]. The MnO₂/nickel foam electrode prepared at a constant current density of 5 mA cm⁻², 10 mA cm⁻² and 15 mA cm⁻² has a capacitance of 179 F g⁻¹, 152 F g⁻¹ and 96 F g⁻¹ at scan rate 10 mV s⁻¹, respectively. The MnO₂/graphene/nickel foam electrode has capacitance value of 221 F g⁻¹, 159 F g⁻¹, and 133 F g⁻¹, confirming that graphene contributes to increase in capacitance [2]. After 1000 cycles, the MnO₂/Nickel foam retention rate was 84% and the MnO₂/graphene/nickel foam capacity retention rate was increased to 90%, confirming that graphene not only supported electrons but also increased the capacitance retention and increased the stability of the electrode sheet.

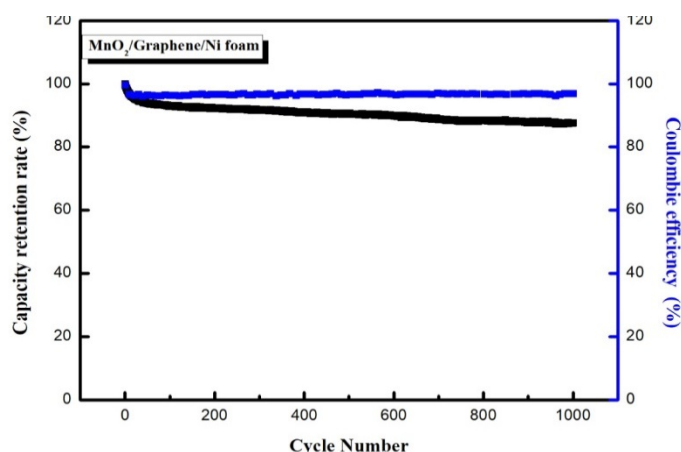

Figure 1: Capacity retention and Coulombic efficiency of MnO₂/graphene/Ni foam electrode.

References

- [1] M. H. Yang and B. G. Choi, *J. Electroanal. Chem.* **776** (2016) 134-138.
- [2] Y. Ding, N. Zhang, J. Zhang, X. Wang, J. Jin, X. Zheng and Y. Fang, *Ceram. Int.* **43** (2017) 5374-5381.

γ -irradiation synthesis of magnetic iron oxide nanoparticles and their ability to decolorize methylene blue organic dye

Sinteza magnetskih nanočestica γ -ozračivanjem i njihova uporaba za obezbojavanje organske boje metilenskog modrila

Ivan Marić,¹ Marijan Gotić,² Goran Štefanić,² Anđela Pustak,¹ Tanja Jurkin¹

¹Ruđer Bošković Institute, Radiation Chemistry and Dosimetry Laboratory, Zagreb, Croatia

²Ruđer Bošković Institute, Center of Excellence for Advanced Materials and Sensing Devices, Research Unit New Functional Materials, Zagreb, Croatia

E-mail: imaric@irb.hr

γ -irradiation is an attractive and ecologically friendly technique for synthesis of magnetic nanoparticles (NPs) at room temperature. It has the advantage of inducing electrons and other reducing species homogeneously throughout the sample. But unlike radiolytic synthesis of noble metal NPs, the radiolytic synthesis of iron oxide NPs is rarely investigated. One of the reasons is a very complex iron oxide chemistry that produces numerous phases. Also, magnetic NPs have a high tendency for agglomeration and due to these reasons, various polymers are used that act as dispersants and stabilizers of magnetic NPs in suspensions as well as growth and surface modifiers. In this work, we studied the influence of γ -irradiation dose, dose rate, pH and type of polymers on the magnetic iron oxide NPs synthesized using γ -irradiation. In order to achieve reducing conditions upon γ -irradiation, iron(III) chloride alkaline aq. solutions were purged with nitrogen in the presence of 2-propanol. Since ferrous ions (Fe^{2+}) that form upon γ -irradiation of iron(III) precursor are highly susceptible to oxidation, the final product depends not only on the γ -irradiation parameters, but also on the process of product isolation. In the presence of DEAE-dextran, irradiation with the dose of 36 kGy resulted in the formation of very small spherical substoichiometric magnetite NPs, whereas at higher dose (130 kGy) the magnetic δ -FeOOH nanodiscs were obtained. On the other hand, irradiation with 130 kGy in the presence of dextran sulfate resulted in the formation of mixed phases such as α -FeOOH, δ -FeOOH and iron(III) hydroxide sulfate. By admixing glycerol in irradiated suspensions, reduced intermediated phases such as $\text{Fe}(\text{OH})_2$ and Green Rust were captured thus confirming that γ -irradiation generated reducing conditions. In addition, we quantitatively determined the concentration of Fe^{2+} produced in irradiated suspensions by spectrophotometric technique (using 1,10-phenanthroline and ferrozine) as well as by redox titration using potassium permanganate, and compared these results with the amount of Fe(II) in isolated powders. The synthesized magnetic NPs were used for decolorization of methylene blue. Methylene blue (MB) is a cationic organic dye, which is used in color staining of domestic objects and in industry. The removal of MB from industrial wastewater is a major concern and attracts world-wide attention, because of its health issues and carcinogenic risks. The amino-dextran synthesized samples slowly and non-completely decolorized MB, however, the magnetic sulfate-dextran samples rapidly and completely decolorize MB within 180 min. Much higher MB decolorization effect of magnetic sulfate-dextran samples in comparison to the DEAE-dextran samples was explained by the formation of metachromatic complex between the cationic MB dye and anionic sulfate groups adsorbed on the magnetic NPs.

Acknowledgment: This work has been supported by Croatian Science Foundation under the project UIP-2017-05-7337 (POLRADNANOP).

The role of structural changes in sodium ion transport mechanism in phosphate glasses

Uloga strukturnih promjena u mehanizmu prijenosa natrijevih iona u fosfatnim staklima

Kristina Sklepić Kerhač,¹ Luka Pavić,¹ Gregory Tricot,² Petr Mošner,³ Ladislav Koudelka,³
Andrea Moguš-Milanković¹

¹*Ruđer Bošković Institute, Division of Materials Chemistry, Zagreb, Croatia*

²*Université de Lille 1, LASIR UMR-CNRS 8516, Villeneuve d'Ascq, France*

³*University of Pardubice, Faculty of Chemical Technology, Czech Republic*

E-mail: ksklepic@irb.hr

The constant rise of special requirements for energy storage systems has resulted in a rapid increase in the research of materials suitable for solid electrolytes and electrodes in all-solid-state ion batteries. In demand for safer, more efficient and less costly solutions, the question arises whether more naturally abundant sodium can replace lithium in ion batteries [1,2].

In this study, two sodium ion conducting glass series are investigated: $40\text{Na}_2\text{O}-(60-x)\text{P}_2\text{O}_5-x\text{GeO}_2$ and $40\text{Na}_2\text{O}-10\text{B}_2\text{O}_3-(50-x)\text{P}_2\text{O}_5-x\text{GeO}_2$, $x=0-30$ mol% in order to verify the mixed glass former effect (MGFE). Glass former exchange resulted in the significant electrical conductivity enhancement for both systems. Such behaviour is related to the increased mobility of Na^+ ions, due to the depolymerization of the (boro)phosphate network and the emergence of easily conductive pathways after germanate incorporation and formation of different mixed Ge/B/P structural units. With the help of 1D/2D MAS NMR techniques, we are able to determine and quantify structural units formed in the network and gain insight into local environment and links between these units, which is crucial for determining the sodium ion transport mechanism.

For better understanding of ionic transport in phosphate glasses, these results are compared to the study of $40\text{Na}_2\text{O}-(60-x)\text{P}_2\text{O}_5-x\text{MoO}_3/\text{WO}_3$, $x=0-50$ mol% glasses. In these systems, the ionic conductivity also increases significantly, as P_2O_5 is replaced by MoO_3/WO_3 (conditional network formers) implying that the mixture of phosphate and molybdate/tungstate units in glass network strongly facilitates transport of Na^+ ions similarly as in classical MGFE. The ability to adjust the electrical properties of these MGFE systems by simple compositional changes and structure tuning is a very useful feature for their specific use.

References

- [1] M. D. Slater, D. Kim, E. Lee and C. S. Johnson, *Adv. Funct. Mater.* **23** (2013) 947-958.
[2] A. Hayashi, K. Noi, A. Sakuda and M. Tatsumisago, *Nat. Commun.* **3** (2012) 856.

Inhibitory action of eucalyptol on aluminum corrosion in model solutions Inhibicijsko djelovanje eukaliptola na koroziju aluminija u modelnim otopinama

Jasna Halambek, Lucija Čović, Ines Cindrić
Veleučilište u Karlovcu, Karlovac, Hrvatska

E-pošta: jasna.halambek@vuka.hr

Metalni materijali još uvijek imaju važnu ulogu pri pakiranju i čuvanju prehrambenih proizvoda, posebice aluminij koji zbog svojih izvanrednih svojstava i dobre korozivne postojanosti zauzima drugo mjesto u ukupnoj potrošnji metala u prehrambenoj industriji. Aluminij i njegove slitine mogu doći u dodir s hranom tijekom proizvodnje, pripreme, a ponajviše čuvanja (limenke, spremnici, folije). Iako se većina prehrambenih proizvoda smatra blago korozivnom sredinom, neki sastojci, bilo prirodni ili dodani tijekom procesa proizvodnje, mogu djelovati jače ili slabije korozivno (različite organske kiseline, natrijev klorid, nitrati, nitriti, fosfati itd.) [1,2]. Dodatak različitih začina i aditiva u korozivnu sredinu može utjecati na smanjenje brzine korozije, tj. takve se komponente mogu smatrati inhibitorima korozije [3,4]. U ovom radu ispitana je inhibicijska djelotvornost eukaliptola na koroziju aluminija u modelnim otopinama limunske kiseline, askorbinske kiseline i natrijeva klorida odnosno 1 % $C_6H_8O_7$, 1 % $C_6H_8O_7$ + 1 % NaCl i 1 % $C_6H_8O_7$ + 1 % NaCl + 1 % $C_6H_8O_6$. Eukaliptol pripada skupini monocikličkih terpena koji se zbog svojega ugodnog mirisa i okusa koristi za poboljšavanje arome pekarskih i konditorskih proizvoda, mesnih prerađevina i bezalkoholnih pića. Ispitivanja provedena gravimetrijskom metodom potvrdila su inhibicijsko djelovanje eukaliptola u svim ispitivanim modelnim otopinama, a najveći stupanj zaštite aluminija postignut je u otopini 1 % limunske kiseline s dodatkom 300 ppm eukaliptola i to od 82,8 %. Koncentracija otopljenog aluminija određena je spektroskopski i kreće se u rasponu od 0,15 mg L⁻¹ do maksimalno 5,83 mg L⁻¹. Na osnovi strukture molekule eukaliptola (1,8-cineola) može se pretpostaviti da se njegove molekule vežu procesom kemijske adsorpcije na površinu aluminija stvarajući zaštitni sloj i na taj način štite aluminij od korozivnog djelovanja ispitivanih otopina. Da bi potvrdili dobivene rezultate inhibicijskog djelovanja eukaliptola na koroziju aluminija, površine aluminija snimljene su metalografskim mikroskopom.

Reference

- [1] M. Šeruga, *Kem. ind.* **40** (1991) 57-61.
- [2] K. Galić i N. Ciković, *Ambalaža* **2** (1996) 14-18.
- [3] J. Halambek, M. Cvjetko-Bubalo, I. Radojčić-Redovniković i K. Berković, *Int. J. Electrochem. Sci.* **9** (2014) 5496-5506.
- [4] A. Ninčević Grassino, J. Halambek, S. Djaković, S. Rimac Brnčić, M. Dent i Z. Grabarić, *Food Hydrocoll.* **52** (2016) 265-274.

Synthesis of cellulose based sorbents for oil spill cleanup Sinteza sorbena na bazi celuloze za uklanjanje naftnih onečišćenja

Elvira Vidović, Roko Blažić, Martina Budimir

Sveučilište u Zagrebu, Fakultet kemijskog inženjerstva i tehnologije, Zagreb, Hrvatska

E-pošta: evidov@fkit.hr

Celuloza je široko rasprostranjen polisaharid čija građevna jedinica sadrži tri hidroksidne skupine koje omogućuju njenu modifikaciju te primjenu derivata celuloze izvan komercijalno ustaljenih područja (tekstil, papir). U ovom radu provedena je kemijska modifikacija celuloze s kloridom oleinske kiseline kako bi se povećala hidrofobnost celuloze. Vezani, graftirani hidrofobni lanci oleinske kiseline omogućuju interakcije s nepolarnim kapljevina, kao na primjer naftnim ugljikovodicima, te primjenu celuloze kao posipnog adsorbensa pri onečišćenju okoliša naftnim produktima. Modifikacija celuloze provedena je u homogenim uvjetima pri različitim molarnim omjerima celuloze i oleinske kiseline (1:1, 1:2, 1:3). Modificirana celuloza karakterizirana je infracrvenom spektroskopijom (FTIR) te termogravimetrijskom analizom (TGA). Osim toga ispitano je bubrenje uzoraka u kloroformu te smjesi dizelskog goriva i vode (80 vol.% / 20 vol.%). Infracrvenom spektroskopijom utvrđena je prisutnost karbonilne skupine te dvostruke veze ugljik-ugljik što ukazuje na uspješnu modifikaciju celuloze kloridom oleinske kiseline. Zabilježena prisutnost vrpce OH skupine u infracrvenom spektru uzorka i s najvećim omjerom celuloza/klorid oleinske kiseline nakon modifikacije ukazuje na stupanj supstitucije manji od 3. Na temelju termogravimetrijske analize utvrđeno je da se toplinska stabilnost celuloze smanjila za ~ 70 °C neovisno o stupnju supstitucije celuloze. Uzorci modificirane celuloze sintetizirani s većim omjerom celuloze i klorida oleinske kiseline (1:2, 1:3) u smjesi dizelskog goriva i vode pokazuju ~ 50 % veći stupanj bubrenja u odnosu na čistu celulozu. Najveći stupanj bubrenja u smjesi dizelskog goriva i vode zabilježen je kod uzorka s omjerom celuloza/klorid oleinske kiseline 1:2.

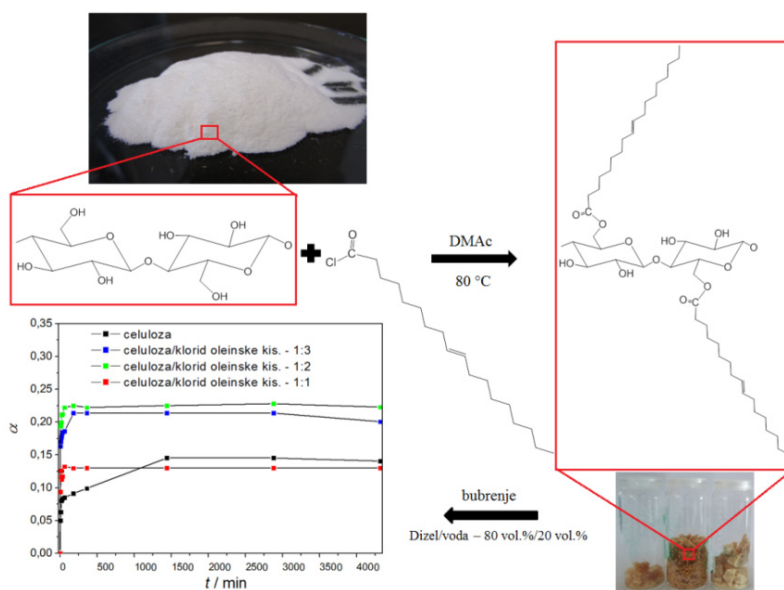

Slika 1: Shematski prikaz modifikacije celuloze s kloridom oleinske kiseline.

Impact of amine structure on the outcome of γ -irradiation of PDMS-based gel networks

Učinak strukture amina na ishod γ -zračenja gelnih mreža na osnovi PDMS-a

Ivana Cetina,¹ Irina Pucić,² Ana Šantić²

¹Croatian Defense Academy "Dr. Franjo Tuđman", Zagreb, Croatia

²Ruđer Bošković Institute, Zagreb, Croatia

E-mail: ivanacetina@gmail.com

PDMS-based "gel networks" [1] with gel-like properties but without a liquid component were obtained by low temperature curing of diglycidyl ether terminated poly(dimethylsiloxane), PDMS-DGE with selected aliphatic amines. Three diamines 1,3-diamino-2-propanol (DAP), diethylenetriamine (DETA) and triethylenetetramine (TETA) and a triamine tris(2-aminoethyl)amine (TAEA) were reacted with PDMS-DGE at 50 °C. To assess their stability to ionizing radiation, obtained gel networks were irradiated in ambient conditions at ⁶⁰Co γ -irradiation facility of Laboratory for Radiation Chemistry and Dosimetry (LRCD), Ruđer Bošković Institute (RBI). Gamma irradiation of PDMS can induce both crosslinking and degradation by chain scission [2]. Because non-irradiated gel networks contained unreacted epoxy groups [3], it was expected that radiation crosslinking will prevail over degradation. While the apparent firmness of gel networks irradiated up to 50 kGy was preserved, Soxhlet extraction in hexane revealed only a slight increase in gel content of most gel networks and even a slight decrease in case of TAEA cured gel network. The changes in thermal and dielectric properties were more pronounced and the radiation response was clearly influenced by the structure of used amine. The gel networks prepared using the amines that can either form hydrogen bonds like DAP or produce denser network like TAEA because of three primary amine groups were less influenced by irradiation. The conductivity of non-irradiated DAP cured gel network was the lowest and it increased very little on irradiation. On the other hand, both electrical conductivity and the enthalpy of endothermic transition of DETA cured gel network increased significantly on irradiation and its conductivity was almost 2 orders of magnitude greater than that of the corresponding non-irradiated one. In case of irradiated TETA cured gel network a slight reduction of the enthalpy of endothermic transition was observed and conductivity change was lower than for DETA cured one. Since Soxhlet extraction of irradiated TETA cured gel network showed a 10% higher gel content, all this indicates that its initial curing was less complete than in case of DETA although the diamines have very similar structure. Even though contribution of DAP, DETA, TETA and TAEA segments to cured PDMS gel networks is relatively small, their structure significantly influenced not only the properties on initial curing but also the outcome of irradiation even at a relatively low dose of 50 kGy.

References

- [1] R. G. Jones, J. Kahovec, R. Stepto, E. S. Wilks, M. Hess, T. Kitayama and W. V. Metanomski, *IUPAC: Compendium of Polymer Terminology and Nomenclature*, RSC Publishing, Cambridge, 2009, pp. 211-236.
- [2] A. S. Palsule, S. J. Clarson and C. W. Widenhouse, *J. Inorg. Organomet. Polym.* **18** (2008) 207-221.
- [3] I. Cetina and I. Pucić, 25th Croatian Meeting of Chemists and Chemical Engineers, Book of abstracts, A. Šantić and M. Đaković, (eds.), p. 210.

Chemical modification of microcrystalline cellulose with long chain methacrylates

Kemijska modifikacija mikroceluloze dugolančanim metakrilatima

Roko Blažić, Elvira Vidović, Boris Kremenjaš

Sveučilište u Zagrebu, Fakultet kemijskog inženjerstva i tehnologije, Zagreb, Hrvatska

E-pošta: rblazic@fkit.hr

Mikroceluloza (MCC) je celuloza mikrometarskih dimenzija dobivena hidrolizom celuloznih vlakana. Mikrometarske dimenzije i biorazgradljivost MCC čine je potencijalnim punilom u polimernim materijalima, ali hidrofilna priroda celuloze onemogućava dobru raspodjelu punila u nepolarnoj polimernoj matrici. Da bi se poboljšala raspodjela unutar nepolarne matrice, provodi se modifikacija površine mikroceluloze. Jedna od metoda kemijske modifikacije površine mikroceluloze je graft-polimerizacija uz metakrilatni monomer u vodenom mediju. Do sada, u literaturi, najčešće je istraživani sustav koji uključuje vezanje poli(metil-metakrilata) na površinu celuloze. Graft-polimerizacija metil-metakrilata (MMA) na celulozi provodi se u vodenom mediju u kojem je monomer (MMA) otopljen, a kao inicijator se upotrebljava cerijev(amonijev) nitrat (CAN) koji omogućava stvaranje radikala na površini MCC te rast polimernog lanca s površine celuloze. U ovom radu istražena je mogućnost graftiranja poli(dodecil-metakrilata) (PDDMA) na površinu mikroceluloze. S obzirom na to da dodecil-metakrilat (DDMA) nije topljiv u vodi, graft-polimerizacija provedena je u metanolu uz CAN kao inicijator. Prilikom polimerizacije mijenjan je omjer DDMA (mmol) / MCC (g) (4 mmol g⁻¹, 10 mmol g⁻¹, 20 mmol g⁻¹). Graftiranje PDDMA na površinu MCC karakterizirano je infracrvenom spektroskopijom, dok je toplinska stabilnost mikroceluloze te modificirane mikroceluloze praćena termogravimetrijskom analizom (TGA). Graftiranje PDDMA na površinu MCC potvrđeno je preko vrpce karakteristične za karbonilnu skupinu u infracrvenom spektru modificirane celuloze. Graftiranjem polimernih lanaca na površinu MCC uočeno je smanjenje toplinske stabilnosti za oko 20 °C u odnosu na čistu celulozu (320 °C) kod uzoraka s nižim omjerom DDMA/MCC (4 i 10 mmol g⁻¹) dok je kod najvišeg omjera zabilježeno sniženje toplinske stabilnosti od oko 70 °C.

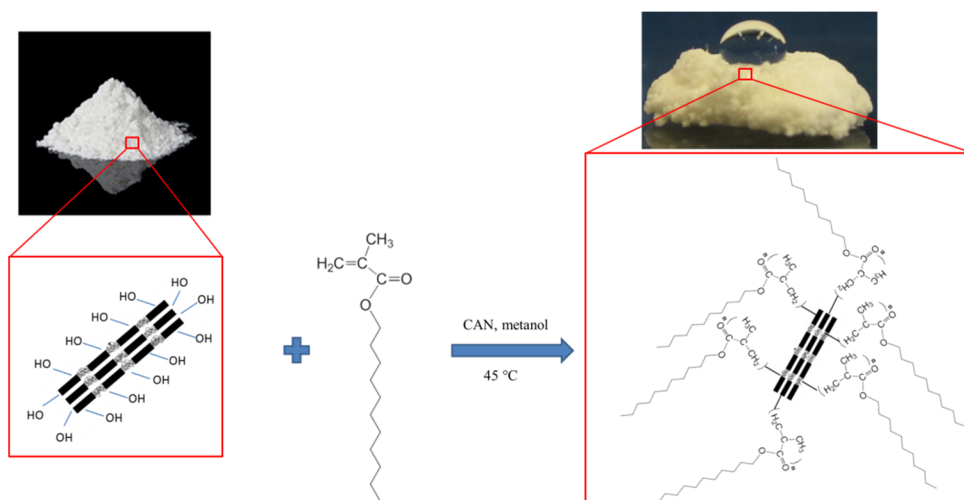

Slika 1: Shematski prikaz modifikacije mikroceluloze dodecil-metakrilatom.

The influence of the synthesis pathway on the morphology of zeolite beta crystals

Utjecaj načina sinteze na morfologiju kristala zeolita Beta

Ivana Landripet, Andreas Puškarić, Josip Bronić
Ruđer Bošković Institute, Zagreb, Croatia

E-mail: ivana.landripet@irb.hr

The BEA framework topology attracts much attention because of the three-dimensional large-pore channel system, large available micropore volume, and the presence of active sites in different concentrations that are useful in a number of acid-catalyzed reactions.

Intracrystalline diffusion of the reactants and products within zeolite crystals is limited, and can be avoided reducing the size of the crystals to nanoscale or by introducing mesoporous voids. Efficiency of the catalytic process can be improved by increasing the number of active places (*i.e.* Lewis and Brønsted acid places).

Samples of hierarchical zeolite beta was made by a feasible one-pot (one-step) method, which is suitable for application in industrial production. Introduction of mesoporous voids (hierarchical structure of the crystals) was obtained using additional mesoporous template (*e.g.* CTAB) during catalyst synthesis, or by postsynthesis treatment of classically synthesized microcrystals by dealumination/desilication. Crystalline size and morphology was adopted by the addition of ammonium fluoride. Fluoride ions have a structure-directing role and induce formation of the nanosized crystals.

The synthesis resulted in micro- and mesoporous zeolite beta (hierarchical structure) with micrometer and nanometer size crystals, what is confirmed using characterization by infrared spectroscopy, X-ray powder diffraction, scanning electron microscopy, particle size analysis and infrared physisorption measurements.

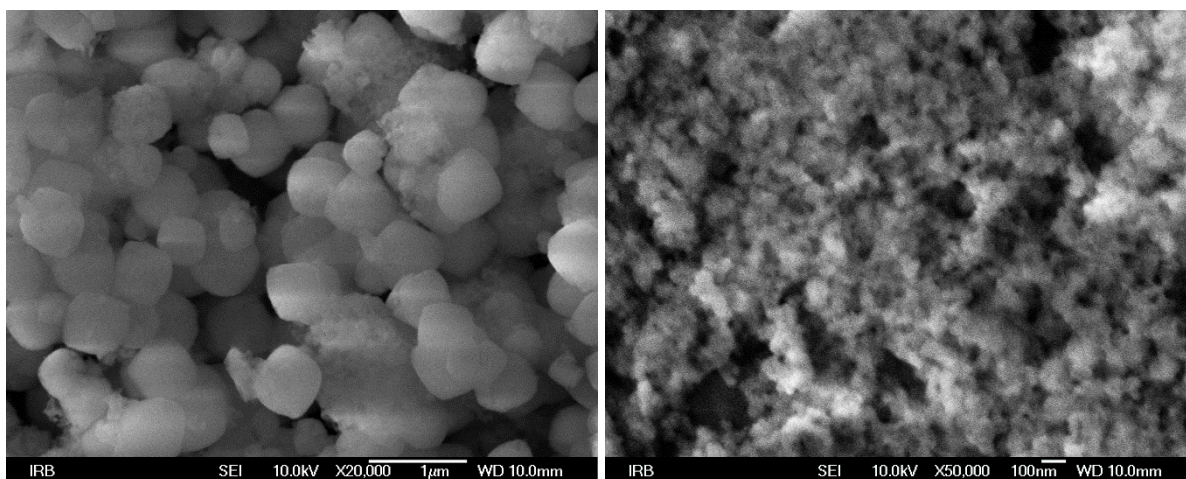

Figure 1: SEM photos of zeolite beta obtained using: (left side) microporous template (TEAOH), and (right side) micro- and mesoporous (CTAB) template with NH_4F .

Acknowledgment: This work was supported by Croatian Science Foundation, Project IP-2016-06-2214.

**Preparation of magnesium substituted hydroxyapatite scaffold – the effect on
in vitro culture with human mesenchymal stem cells**
**Priprema magnezijem supstituiranog hidroksiapatitnog nosača –
utjecaj na kulturu *in vitro* s ljudskim mezenhimskim matičnim stanicama**

Leonard Bauer,¹ Anamarija Rogina,¹ Maja Antunović,¹ Inga Marijanović,² Marica Ivanković,¹
Hrvoje Ivanković¹

¹Sveučilište u Zagrebu, Fakultet kemijskog inženjerstva i tehnologije, Zagreb, Hrvatska

²Sveučilište u Zagrebu, Prirodoslovno-matematički fakultet, Biološki odsjek, Zagreb, Hrvatska

E-pošta: lbauer@fkit.hr

Mineralni dio ljudske kosti sastoji se od prirodnog nestehiometrijskog hidroksiapatita ($\text{Ca}_{10}(\text{PO}_4)_6(\text{OH})_2$) koji sadrži različite supstituente [1]. Magnezijev ion (Mg^{2+}) je, nakon karbonatnog iona (CO_3^{2-}), drugi najzastupljeniji supstituent u hidroksiapatitu koji znatno utječe na biološka svojstva i aktivnost koštanog tkiva [2,3].

Cilj rada je sustavnim istraživanjem utjecaja količine magnezijeva iona doprinijeti razumijevanju utjecaja parametara sinteze na strukturu i svojstva novog biokompatibilnog materijala temeljenog na hidroksiapatitu za primjenu u inženjerstvu koštanog tkiva. Iz sipine kosti, biogenog aragonitnog (CaCO_3) materijala visoke poroznosti i strukture slične ljudskoj kosti, hidrotermalno je sintetiziran karbonatni hidroksiapatit supstituiran magnezijem iz magnezijeva perklorata ($\text{Mg}(\text{ClO}_4)_2$).

Karakterizacijom materijala utvrđena je predominantna supstitucija karbonatom B-tipa (ugradnja CO_3^{2-} na poziciju PO_4^{3-}) svojstvena biološkim apatitima [4]. Potvrđeno je da supstitucija kalcija magnezijevim ionom manjeg ionskog radijusa od kalcija smanjuje veličinu kristalne ćelije hidroksiapatita te povećava njegovu topljivost odnosno brzinu bioresorpcije koštanog nadomjestka. Nakon što je indirektnom analizom *in vitro* s ljudskim embrionalnim stanicama (Hek293) potvrđeno da sintetizirani materijal nije citotoksičan, proveden je eksperiment *in vitro* s kulturom mezenhimskih matičnih stanica u trajanju od 21 dana. Provedene histološke analize potvrdile su nastanak kalcij-fosfatnih depozita te izraženiju pojavu kolagena i osteokalcina kod uzorka hidroksiapatita supstituiranog s 1 % magnezija. Može se zaključiti da sintetizirane, magnezijem supstituirane okosnice hidroksiapatita pogoduju razvoju stanica više nego nesupstituirani hidroksiapatit.

Reference

- [1] J. B. Park, *Biomaterials Science and Engineering*, Plenum Press, New York, 1984
- [2] R. Z. LeGeros, R. Kijkowska, C. Bautista i J. P. LeGeros, *Connect. Tissue Res.* **33** (1995) 203-209.
- [3] A. Laskus i J. Kolmas, *Int. J. Mol. Sci.* **18** (2017) 2542-2564.
- [4] B. Wopenka i J. D. Pasteris, *Mater. Sci. Eng. C-Mater.* **25** (2005) 131-143.

Response of some poly(ethylene-terephthalate) based nanocomposites to various radiation types

Odziv nekih nanokompozita na osnovi poli(etilen-tereftalata) na različite vrste zračenja

Irina Pucić,¹ Ivana Cetina²

¹Ruđer Bošković Institute, Zagreb, Croatia

²Croatian Defense Academy "Dr. Franjo Tuđman", Zagreb, Croatia

E-mail: Irina.Pucic@irb.hr

The radiation response of polymers and (nano)composites depends on polymer matrix structure and radiation type. The overall outcome can be cross-linking and/or degradation [1]. The addition of (nano)fillers is expected to increase radiation stability of polymers [2]. Poly(ethylene-terephthalate), PET is a widely used thermoplastic polymer with excellent engineering properties. Unlike its photostability, the stability of PET to gamma-radiation is relatively high. The aim of this work was to assess how the addition of selected nanofillers influenced stability of PET to those types of radiation. Two PET nanocomposites based on 150 μm PET film, one containing 1% of nano-diamonds and the other containing combination of 1% of nano-diamonds and 0.5% graphene nanoplatelets [3] were studied in comparison to corresponding pure PET film and to another PET film, 12 μm thick, biaxially oriented to better distinguish structural changes if any. A part of the samples was gamma-irradiated in ambient conditions at ⁶⁰Co γ -irradiation facility of Laboratory for Radiation Chemistry and Dosimetry, Ruđer Bošković Institute (RBI) in Zagreb, Croatia to doses of order of MGy. Other samples were exposed to UV irradiation of 254 nm also in ambient conditions.

The samples were characterized by thermal analysis and FTIR spectroscopy. The addition of nanoparticles did not produce significant changes to non-irradiated PET except that graphene shifted its crystallization temperature to higher values. On the other hand nanoparticles influenced the response of PET to both types of radiation and it varied depending on the nanocomposite composition. All samples were relatively stable to gamma-radiation below 1 MGy and retained their mechanical properties. At higher gamma-dose of 2 MGy only biaxially oriented 12 μm thick PET film remained unaffected while all 150 μm films became brittle and cracked easily. Graphene and nanodiamond containing nanocomposite was somewhat less resistant to gamma-radiation than the one with nano-diamonds only or pure PET that had similar stability. Nanodiamonds slightly increased the stability of PET to photodegradation while additional graphene reduced the stability below that of pure PET film.

References

- [1] S. Aarya, K. Dev, S. K. Raghuvanshi, J. B. M. Krishna and M. A. Wahab, *Radiat. Phys. Chem.* **81** (2012) 458-462.
- [2] G. Wypych, *Handbook of Fillers*, 2nd ed., ChemTec Publishing, Toronto, 2000, pp. 485-495, 501-505.
- [3] L. Bistričić, V. Borjanović, M. Leskovac, L. Mikac, G. E. McGuire, O. Shenderova and N. Nunn, *J. Polym. Res.* **22** (2015) 39-51.

Cellulose-nanofibres-derived 3D graphene-like networks in sintered ceramic matrices

Trodimenzijske, grafenu slične mreže u sinteriranim keramičkim matricama izvedene iz celuloznih nanovlakana

Andraž Kocjan,¹ Ana Lazar,¹ Eduardo Ruiz-Hitzky,² Bernd Wicklein²

¹Department for Nanostructured Materials, Jožef Stefan Institute, Ljubljana, Slovenia

²Instituto de Ciencia de Materiales de Madrid (ICMM), Consejo Superior de Investigaciones Científicas (CSIC), Madrid, Spain

E-mail: andraz.kocjan@ijs.si

Establishing a 3D electrically percolating network in an insulating ceramic matrix is a key to numerous engineering and functional applications. To this end, using hydrophobic carbon nanofillers like graphene or carbon nanotubes is tempting, but still results in suboptimal performance due to processing challenges including colloidal instabilities in aqueous media. Here, we demonstrate an alternative, sustainable way by a small addition of cellulose nanofibers (CNF), which render highly homogeneous aqueous ceramic dispersions due to the increased hydrophilicity character and facilitates green machining of the consolidated green bodies. During sintering, natural CNFs [1] can be *in situ* transformed into graphene-like sheets connected to a 3D network enhancing both the transport and the mechanical properties of sintered Al₂O₃ and yttria-stabilised ZrO₂ (YSZ) ceramic matrices [2,3]. The advantage presented here is the colloidal processing in water of CNF hydrogels with ceramic powder suspensions, which guarantees uniform and homogeneous properties from the bulk scale down to the nanoscale. The network architecture of the few-layered graphene (FLG) sheets also permits the decoupling of electrical and thermal conductivities, which represents a major obstacle in attaining efficient thermoelectric materials. The microstructure of the resulting materials was characterised by electron microscopy and spectroscopy (STEM/EELS), while the electrical and dielectrical properties were analysed by impedance spectroscopy. The materials showed high electrical conductivity at only 2% initial CNF content, while the FLG-YSZ nanocomposites exhibited mixed ionic-electronic conduction at ≤1% CNF, which is interesting for electrode materials in solid-oxide fuel cells.

Besides the transport properties, the incorporated CNF improve the (green) mechanical properties and also enable the use of technologically important machining methods for electro-conductive ceramics. We envisage that our results can advance the processing science and technology to provide the improved hierarchical graphene composite materials needed for advanced applications in fields like energy and telecommunications.

References

- [1] B. Wicklein, A. Kocjan, G. Salazar-Alvarez, F. Carosio, G. Camino, M. Antonietti and L. Bergström, *Nature. Nanotech.* **10** (2015) 277-284.
- [2] A. Kocjan, R. Schimdt, A. Lazar, J. Prado-Gonjal, J. Kovač, M. Logar, F. J. Mompean, M. Garcia-Hernandez, E. Ruiz-Hitzky and B. Wicklein, *Nanoscale* **10** (2018) 10488-10497.
- [3] A. Kocjan, B. Wicklein and E. Ruiz-Hitzky, Patent PCT/EP2017/078239.

Preparation of monolithic catalyst supports using 3D-printing technology Priprema monolitnih nosača katalizatora tehnologijom 3D-ispisa

Filip Car, Vesna Tomašić, Domagoj Vrsaljko
Sveučilište u Zagrebu, Fakultet kemijskog inženjerstva i tehnologije, Zagreb

E-pošta: fcar@fkit.hr

Pojam se monolita u reakcijskom inženjerstvu odnosi na tvorevine nepromjenjive i pravilne geometrije, koje u pravilu služe kao nosači katalitički aktivnih komponenti, tj. katalizatora. Monolitni se katalizator uglavnom dobiva na način da se na stijenke osnovne, u pravilu inertne monolitne strukture, nanese sloj nosača koji sadrži katalitički aktivne tvari, tj. jedan ili više katalitičkih materijala (najčešće Pt, Pd, Rh i sl.).

U ovom je radu za izradu monolitnih nosača katalizatora primijenjen postupak stereolitografije (SLA) koji se ubraja u postupke aditivne proizvodnje, tj. 3D-ispis. Za izradu monolitnih nosača korištena je komercijalna smola *Ceramic Resin* proizvođača Formlabs. Pritom je (slika 1) definirano nekoliko željenih oblika kanala te dimenzije kanala i debljina stijenki monolita.

Rezultati ispitivanja pokazali su da je orijentacija modela tijekom 3D-ispisa važan čimbenik, pri čemu se jedino izrada modela postavljenog okomito na podlogu pokazala zadovoljavajućom. Kod izrade modela postavljenih pod kutom od 20° u odnosu na osi x i y primijećeno je da su svi izrađeni modeli imali ukošene kanale, što nije bio slučaj kod izrade modela s drugim vrstama smola za 3D-ispis. Svaku dimenziju pojedinog modela tijekom pripreme za 3D-ispis potrebno je uvećati za određeni faktor kako bi kompozitni monolit nakon pirolize i sinteriranja imao ciljane dimenzije. Ovisno o modelu korišteni su faktori povećanja od 1,00 do 1,25 za osi x i y te od 1,12 do 1,40 za os z. Kod izrađenih modela primijećeno je smanjivanje vanjskog promjera za 9 do 16 % i duljine za 16 do 22 %.

Iz dobivenih rezultata zaključuje se da se kod izrade modela posebna pozornost mora obratiti na odabir optimalnih faktora uvećanja modela za sve tri koordinatne osi kako bi se izradili modeli zadovoljavajućih konačnih oblika i dimenzija te osigurala potrebna mehanička stabilnost.



Slika 1: Monolitni nosači katalizatora izrađeni 3D-ispisom.

**POSTERSKA PRIOPĆENJA
ZAŠTITA OKOLIŠA**

***POSTER PRESENTATIONS
ENVIRONMENTAL PROTECTION***

Development of the device for preparation of the reference sample for the flow velocity and concentration of solid particles in waste gas Razvoj uređaja za pripremu referentnog uzorka brzine strujanja i koncentracije krutih čestica u otpadnom plinu

Hrvoje Nikl,¹ Matija Cvetnić,² Tomislav Bolanča,² Marko Rogošić²

¹*Cerium d.o.o., Zagreb, Hrvatska*

²*Fakultet kemijskog inženjerstva i tehnologije Sveučilišta u Zagrebu, Hrvatska*

E-pošta: hrvoje.nikl@cerium.hr

Dio redovitoga postupka akreditacije ispitnih i umjernih laboratorija je i međulaboratorijska usporedba koja, između ostaloga, zahtijeva i određivanje sustavne pogreške laboratorija (engl. *laboratory bias*) koji se najčešće određuje pomoću tzv. referentnih materijala ili uzoraka poznate vrijednosti mjerenoga svojstva.

U radu je opisana izvedba postrojenja za pripremu referentnog uzorka brzine strujanja i koncentracije krutih čestica u otpadnom plinu iz nepokretnog izvora s ciljem provedbe međulaboratorijske usporedbe. Budući da u literaturnim podacima ne postoji model prema kojem se može odrediti odgovarajući kriterij međulaboratorijske usporedbe, jer su u stvarnim uvjetima mjerenja rezultati promjenjivi, ne postoji definirani referentni uzorak. Stoga mjerenje teško može zadovoljiti uvjete stabilnosti, homogenosti, ponovljivosti i obnovljivosti koncentracije krutih čestica u otpadnome plinu. Problem je riješen izvedbom postrojenja koje omogućava provođenje međulaboratorijskih usporednih mjerenja s visokom preciznošću i točnošću što rezultira točnim ocjenjivanjem sposobnosti svakog pojedinog laboratorija za provedbu odgovarajućih mjerenja.

Postrojenje se sastoji od dimovodnog kanala, centrifugalnog ventilatora, dozatora čestica i platforme za provedbu mjerenja. Stalan protok zraka u kanalu te ravnomjerno doziranje mase praha (stakleni baloni Tip K, proizvođač 3M) u jedinici vremena rezultirat će točnom masenom koncentracijom krutih čestica u plinu. Za provjeru točnosti računskih vrijednosti brzine strujanja plina i koncentracije krutih čestica odabrana su mjerna mjesta koja zadovoljavaju zahtjeve normi za odgovarajuća mjerenja (ISO 10780, ISO 9096, ISO 13284-1).

Homogenost referentnog uzorka dokazana je provedbom niza mjerenja i ispitivanja te statističkom analizom rezultata. Stabilnost i homogenost brzine strujanja plina na odabranom mjernom mjestu potvrđena je mjerenjem diferencijalnoga i statičkoga tlaka i temperature u definiranim točkama poprečnog presjeka dimovodnoga kanala, zatim mjerenjem atmosferskoga tlaka te izračunavanjem brzine strujanja plina. Nakon toga dokazana je homogenost i stabilnost koncentracije krutih čestica. Nakon dokazivanja homogenosti, stabilnosti i ponovljivosti rezultata mjerenja, definirane su referentne vrijednost brzine strujanja plina i koncentracije krutih čestica te odgovarajuće mjerne nesigurnosti čime je ostvaren postavljeni cilj.

Application of ferrates(VI) for the removal of pharmaceuticals in water Primjena ferata(VI) za uklanjanje farmaceutika u vodi

Josipa Papac, Marin Kovačić, Ana Lončarić Božić

Faculty of Chemical Engineering and Technology of the University of Zagreb, Zagreb, Croatia

E-mail: jpapac@fkit.jr

The application of pharmaceuticals is a growing problem and also a main pathway for their introduction into waste water. Some pharmaceuticals are present within the Water Framework Directive and classified in the group of emerging water pollutants because of their harmful effects to the environment and human health [1]. Even though they have been detected in low concentrations (ppm, ppb) in the environment, they represent a problem due to their physicochemical features and properties. Therefore it is a matter of high importance to consider synergistic effect of their mixtures which can result with even more far-reaching consequences for the environment [2]. Conventional waste water treatment systems have a low efficiency for removal of pharmaceuticals and they remain in the water after treatment. The development of new methods for waste water treatment with a higher effectiveness is necessary. Lately, ferrates (VI) became a promising new oxidation agent. Due to their high oxidation potential ($E^{\circ} = +2.20$ V in acidic media) they have shown high efficiency for removal and degradation of organic pollutants in water [3].

The aim of this work was to establish the level of removal of pharmaceuticals such as carbamazepine, dexamethasone and diclofenac as separate substances or in a mixture using potassium ferrate (K_2FeO_4) in aqueous media. For that purpose the design of experiment and response surface methodology were applied for establishing optimal conditions in a batch reactor. The process was followed by high performance liquid chromatography (HPLC) with diode array detector (DAD) for the determination of the concentration of pharmaceuticals during treatment. Besides that, environmental aspects such as chemical oxygen demand (COD) and total organic carbon (TOC) have been established. Changes of water quality parameters, e.g. chemical oxygen demand (COD) and total organic carbon (TOC) indicated a low mineralization extent.

References

- [1] Water Framework Directive, WFD (2000/60/EC)
- [2] F. Pomati, C. Orlandi, M. Clerici, F. Luciani and E. Zuccato, *Toxicol. Sci.* **102** (2008) 129-137.
- [3] K. V. Sharma, L. Zboril and S. J. Varma, *Acc. Chem. Res.* **48** (2015) 182-191.

Acknowledgment: This study has been fully supported by the Croatian Science Foundation under the project Modeling of Environmental Aspects of Advanced Water Treatment for Degradation of Priority Pollutants, MEAoWT (IP-09-2014-7992).

**Photooxidative degradation of pharmaceuticals and pesticides in water:
mechanistic modelling approach**
**Fotooksidativna razgradnja farmaceutika i pesticida u vodi:
mehanističko modeliranje**

Antonija Tomić, Matija Cvetnić, Tomislav Bolanča, Mirjana Novak Stankov, Šime Ukić, Hrvoje Kušić, Ana Lončarić Božić

University of Zagreb, Faculty of Chemical Engineering and Technology, Zagreb, Croatia

E-mail: atomic@fkit.hr

Pharmaceuticals and pesticides are of particular concern due to their ubiquity in the aquatic environment and their health effects. They are often hardly biodegradable and physicochemical technologies are required for their removal from water. For these reasons there is a need to explore effective and environmentally acceptable methods of treatment for the removal of pharmaceuticals and pesticides from water. Amongst possible solutions, advanced oxidation processes (AOPs) show great potential. AOPs are based on the generation of highly reactive radical species, primarily hydroxyl radicals (HO[•]) and are capable to provide complete degradation/mineralization of the majority of organics in water.

This work deals with the degradation effectiveness of the UV-C/H₂O₂ oxidation of seventeen pharmaceuticals and pesticides. Several process parameters were monitored: conversion and mineralization kinetics of the investigated pollutant, oxidant consumption, and change of pH-values during the treatment. Based on these parameters, a mathematical/mechanistic model (MM) was developed to predict process effectiveness of UV-C/H₂O₂ oxidation for the degradation of pharmaceuticals and pesticides.

MM was employed in order to simultaneously predict the behavior of several process responses providing a solid base for future scale-up. The developed MM is flexible and accurate. It can be used for the prediction of degradation effectiveness of pharmaceuticals and pesticides with complex structures by UV-C photo-assisted AOPs in the presence of hydrogen peroxide as oxidant.

**Kinetic studies of nitrofurantoin photolysis and identification of
photodegradation products**
**Kinetika fotolitičke razgradnje nitrofurantoina i identifikacija produkata
fotorazgradnje**

Martina Biošić,¹ Dario Dabić,¹ Irena Škorić,² Sandra Babić¹

¹*Department of Analytical Chemistry, Faculty of Chemical Engineering and Technology, University of Zagreb, Zagreb, Croatia*

²*Department of Organic Chemistry, Faculty of Chemical Engineering and Technology, University of Zagreb, Zagreb, Croatia*

E-mail: iskoric@fkit.hr

Today it is well established that continuous input and persistence of pharmaceuticals in the environment could have a great impact not only on the environment, but also on human health. Therefore, public and scientific concern on this topic has progressively increased. Nitrofurantoin is an antibiotic frequently used in human for the treatment of urinary tract infection with relatively high excretion rate (approximately one third excreted unchanged in urine). Since information about its fate and behaviour in the environment is negligible compared to some other pharmaceuticals, the objective of this study was to investigate its photolytic degradation under environmentally relevant conditions.

Nitrofurantoin was irradiated under simulated sunlight in different water matrices in order to investigate influence of both direct and indirect photolysis. Besides that, influence of different water constituents (humic acids, chloride, nitrate, phosphate and sulphate ions) on its photolytic degradation was also studied. Furthermore, pH-value as one of the important factors that can have an effect on photolysis was also taken into account.

Besides kinetic investigation of nitrofurantoin photolysis, the photodegradation products were identified and their toxicity, together with toxicity of active component was determined by *Vibrio fischeri* bacteria.

Acknowledgment: This study has been partly supported by the Croatian Science Foundation under the project Fate of pharmaceuticals in the environment and during advanced wastewater treatment (PharmaFate) (IP-09-2014-2353).

**Interlaboratory comparison measurement of gas velocity and concentration
of solid particles in the waste gas**
**Međulaboratorijsko usporedbeno mjerenje brzine strujanja i koncentracije
krutih čestica u otpadnom plinu**

Hrvoje Nikl,¹ Matija Cvetnić,² Marko Rogošić,² Tomislav Bolanča²

¹*Cerium d.o.o., Zagreb, Hrvatska*

²*Fakultet kemijskog inženjerstva i tehnologije Sveučilišta u Zagrebu, Hrvatska*

E-pošta: hrvoje.nikl@cerium.hr

U radu je opisano prvo međulaboratorijsko usporedbeno mjerenje brzine strujanja i koncentracije krutih čestica u otpadnom plinu na postrojenju posebno konstruiranom upravo za tu namjenu. S obzirom na sve izraženije opterećenje okoliša otpadnim emisijama, zakonski okvir propisuje, između ostalog, metode mjerenja i učestalost mjerenja koncentracije krutih čestica u zraku iz nepokretnih izvora. Budući da ne postoje standardizirani načini provjere mjernih sposobnosti laboratorija koje se bave tim mjerenjima, konstruirano je postrojenje koje daje referentne vrijednosti brzine strujanja plina i masene koncentracije krutih čestica u otpadnom plinu. Takav referentni uzorak zadovoljava sve uvjete stabilnosti, homogenosti, ponovljivosti i obnovljivosti. Stoga se iz rezultata dobivenih na uređaju može s visokom preciznošću i točnošću odrediti standardna devijacija međulaboratorijskog usporedbenog mjerenja potrebna za ocjenu pojedinih laboratorija.

Kako bi laboratoriji dokazali svoju mjernu sposobnost, u svakom akreditacijskom ciklusu (najmanje jednom u pet godina) moraju prisustvovati međulaboratorijskome usporedbenome mjerenju za metode za koje su akreditirani. U ovdje opisanom mjerenju sudjelovala su četiri neovisna ispitna laboratorija akreditirana prema međunarodnoj normi ISO/IEC 17025 za mjerenje emisije onečišćujućih tvari u zrak iz nepokretnih izvora. Na temelju eksperimentalnih rezultata i njihove statističke obrade određene su standardne devijacije, odnosno odabran je kriterij međulaboratorijskoga usporedbenoga mjerenja brzine strujanja plina i koncentracije krutih čestica u otpadnom plinu. Uspješnost pojedinog laboratorija ocijenjena je izračunavanjem z-vrijednosti propisane normom (ISO/IEC 17043, ISO 13528). Tri od četiri laboratorija dobila su zadovoljavajuće rezultate mjerenja brzine strujanja plina, dok su sva četiri laboratorija dobila zadovoljavajuće rezultate mjerenja koncentracije krutih čestica u otpadnom plinu.

Uspješna provedba opisanoga mjerenja zaokružuje izvornu zamisao da je takav uređaj za međulaboratorijsko usporedbeno mjerenje brzine strujanja i koncentracije krutih čestica u otpadnom plinu moguće izvesti i, nakon eksperimentalne provjere, uvesti u redovni akreditacijski ciklus. Rezultate međulaboratorijske usporedbe pojedini laboratoriji mogu koristiti u određivanju vlastite mjerne nesigurnosti, kako samih metoda, tako i rezultata mjerenja.

Ultrafiltracija kao predobrada kod uporabe sekundarnog efluenta s nanofiltracijom/reverznom osmozom: šuplja vlakna vs. ravne membrane Ultrafiltration as a pretreatment for secondary effluent reclamation with nanofiltration/reverse osmosis: flat sheet vs. hollow fiber membranes

Marko Racar, Klaudija Obajdin, Davor Dolar, Krešimir Košutić

Sveučilište u Zagrebu, Fakultet kemijskog inženjerstva i tehnologije, Zagreb, Hrvatska

E-pošta: mracar@fkit.hr

Istražena je ultrafiltracijska (UF) predobrada sekundarnog efluenta (SE) s ciljem njegove uporabe nanofiltracijom (NF) i reverznom osmozom (RO). U tu svrhu korištene su UF membrane u obliku šupljih vlakana (ZW-1) i ravne membrane (MW), a UF permeat obrađivan je s NF membranama (NF90 i NF270) te RO membranom (XLE). Radi utvrđivanja mehanizma blokiranja NF/RO membrana provedeno je modeliranje samoga fenomena blokiranja. Permeat dobiven nakon UF, NF i RO karakteriziran je radi utvrđivanja ispunjavanja standarda za ponovnu upotrebu vode u postrojenju za termičku obradu životinjskih nusprodukata (PTOŽN). ZW-1 membrana ublažila je pad protoka permeata u iznosu od 67,0% za NF270, 1,6% za NF90 i 38,0% za XLE membranu, dok je MW ravna membrana smanjila pad protoka 72,4% za NF270, 50,1% za NF90 i 68,1% za XLE. Rezultati modeliranja pokazali su da do blokiranja membrana dolazi zbog djelomičnog i potpunog blokiranja pora. Eksperimentalno je utvrđeno da su NF270 i XLE membrane manje sklone blokiranju. Najbolja kvaliteta permeata dobivena je s XLE membranom, odnosno njegove fizikalno-kemijske značajke zadovoljavaju standardne uvjete vode za proizvodnju pare. Ultrafiltracija SE s ravnom MW membranom rezultirala je smanjenjem blokiranja membrana i nastajanjem permeata koji je, uz naknadnu preventivnu dezinfekciju, prikladan za ponovnu upotrebu tijekom pranja u PTOŽNu. Kao najbolja metoda za obradu i uporabu sekundarnog efluenta pokazala se primjena UF s ravnom MW membranom u prvom koraku, a zatim RO s XLE membranom.

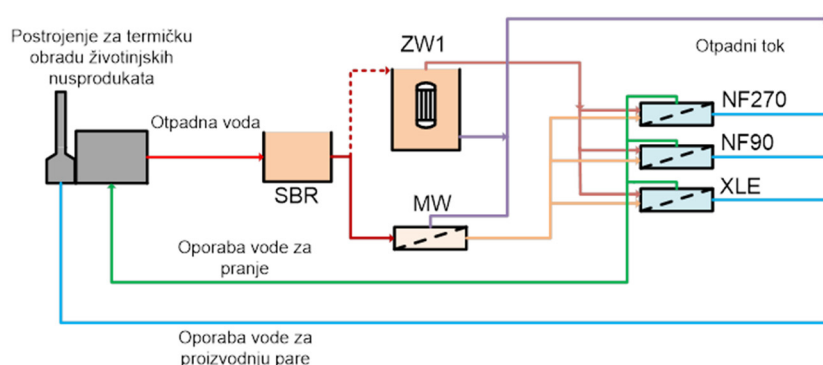

Slika 1: Shema procesa.

Napomena: Ovaj rad financiran je (1.492.908,72 HRK) u sklopu Programa Vlade Republike Hrvatske za poticanje istraživačkih i razvojnih aktivnosti u području klimatskih promjena za razdoblje od 2015. do 2016. godine uz podršku Ministarstva znanosti i obrazovanja, Ministarstva zaštite okoliša i prirode te energetske učinkovitosti i Hrvatske zaklade za znanost, u sklopu projekta *Izravna uporaba komunalne otpadne vode za navodnjavanje membranskim tehnologijama* (ReHOHMem) (PKP-2016-06-8522).

The influence of different natural and anthropogenic inhibitors on calcium carbonate precipitation in artificial karst water

Djelovanje različitih prirodnih i antropogenih inhibitora na taloženje kalcijeva karbonata u umjetnoj krškoj vodi

Nives Matijaković, Damir Kralj

Laboratory for Precipitation Processes, Ruđer Bošković Institute, Zagreb, Croatia

E-mail: nmatijak@irb.hr

Tufa is a natural, porous calcium carbonate material, which is predominantly calcite or magnesium calcite. Tufa is formed by deposition of calcium carbonate in fresh water streams, in the area of intensive water splashing (waterfalls) [1]. By degradation of plant material present, either in the water streams or on the riverside, complex organic molecules, like humic or fulvic acids are produced. Indeed, both classes of molecules are known to strongly inhibit the growth and deposition of calcium carbonate [2]. In addition, pollutants in the form of phosphates or various polyphosphates, which appear in the environment as a result of human activities, may significantly influence and inhibit the CaCO_3 precipitation [3]. The aim of this research was to propose and investigate a simple laboratory model of the tufa precipitation [4] in a presence of natural and anthropogenic additives: humic acid, fulvic acid, phosphate ions and polyphosphate ions. The experiments have been performed at different temperatures, while the polymorphic composition and morphology of spontaneously precipitated calcium carbonate have been determined, as well as the growth kinetics. The results indicated that the additives have a major influence on the polymorph composition, crystal morphology as well as on the kinetics. The strongest effect has been obtained in the presence of polyphosphates: humic acid < fulvic acid < phosphate < polyphosphate.

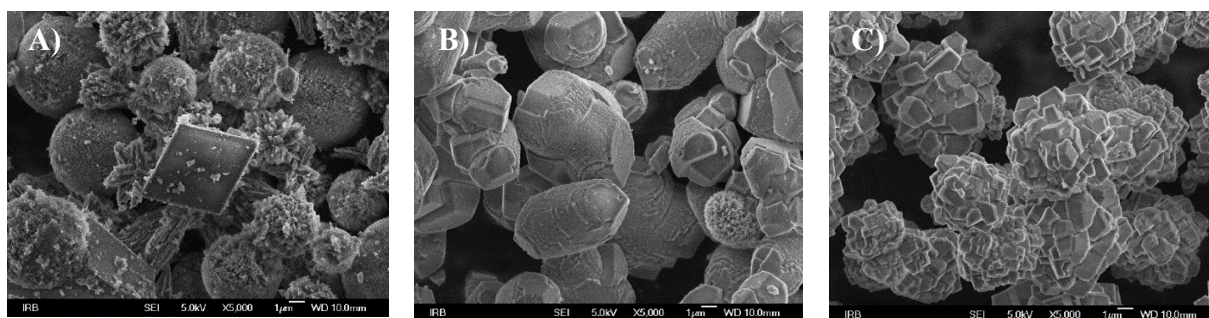

Slika 1: Scanning electron micrographs of the calcite samples precipitated in the presence of different concentrations of fulvic acid: A) $c_{\text{ful}} = 0$ ppm; B) $c_{\text{ful}} = 2$ ppm; C) $c_{\text{ful}} = 5$ ppm.

References

- [1] A. Sironić, J. Barešić, N. Horvatinčić, A. Brozinčević, M. Vurnek and S. Kapelj, *Appl. Geochem.* **78** (2017) 12-22.
- [2] N. Vdović and D. Kralj, *Colloids Surf.* **161** (2000) 499-505.
- [3] Y. Boulahlib-Bendaoud, S. Ghizellaoui and M. Tlili, *Desalin. Water Treat.* **38** (2012) 271-277.
- [4] K. Kovač, B. Sc. Thesis, University of Zagreb, Faculty of Science, Zagreb, 2008.

SEM/EDS analysis of the epiphytic lichen *Evernia prunastri* as the bioindicator of air pollution

SEM/EDS analiza epifitskog lišaja *Evernia prunastri* kao bioindikatora onečišćenja zraka

Emina Ramić,^{1,2} Jasna Huremović,² Sabina Žero,² Almir Olovčić²

¹Faculty of Pharmacy, University of Sarajevo, Sarajevo, Bosnia and Herzegovina

²Faculty of Science, University of Sarajevo, Sarajevo, Bosnia and Herzegovina

E-mail: emina.ramic@ffsa.unsa.ba

Epiphytic lichens are efficient air pollution biomonitors as they obtain nutrients, water and pollutants from the atmosphere. The aim of this study was at analyzing the surface of hyphae and the surface of the lichens *Evernia prunastri* (unwashed and washed in distilled water). Mass percentage of 26 selected elements: C, O, Na, Mg, Al, Si, P, S, Cl, K, Ca, V, Cr, Mn, Fe, Co, Ni, Cu, Zn, As, Cd, Sn, Sb, Hg, Pb and Bi was determined by scanning electron microscopy (SEM) and energy-dispersive X-ray spectroscopy (EDS). Mass percentage of: Na, Mg, V, Cr, Mn, Co, Ni, Zn, As, Cd, Sn, Sb, Hg, Pb was below the limit of detection of the applied method. The mass percentage of all other determined elements on the hyphae and surface of lichen was higher in unwashed samples, except for C, O, P, Fe, Cl, Ca and Cu. The elemental analysis of the unwashed lichen surface showed the prevalence of: O, C, Si, Cu and Bi. Results obtained in the unwashed and washed lichen samples showed that the cleaning with water can be used in order to eliminate adhering materials. Indeed, most of elements of interest for the environmental contamination accumulated by the lichens were not removed. SEM images showed particles that are flat, with irregular shape and edges, generally smooth and rounded indicating that the particles deposited were dry aerosol particles.

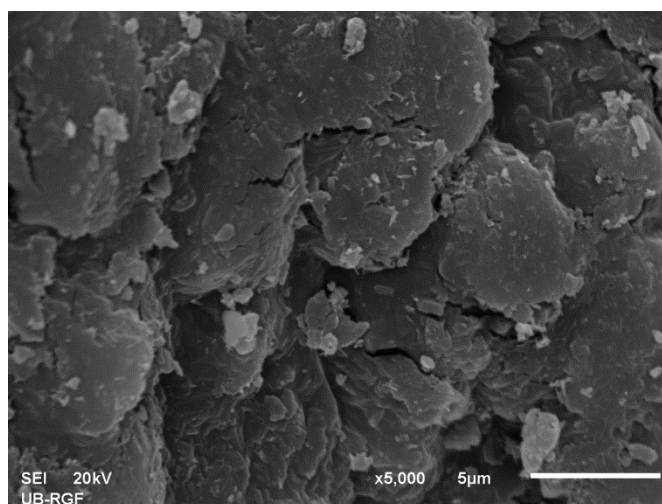

Figure 1: The SEM microscopic image of the unwashed surface of lichen *Evernia prunastri*.

Biosorption removal mechanism of U(VI) ions from aqueous solution Mehanizam uklanjanja U(VI) iona biosorpcijom iz vodenih otopina

Elma Šabanović, Mustafa Memić

University of Sarajevo, Faculty of Sciences, Department for Chemistry, Sarajevo, B&H

E-mail: elma_2508@hotmail.com

Uranium represents an important inorganic pollutant. Disposed into the soil, it may reach water, plants, food and finally it may be ingested by humans, while its chemical and radioactive toxicities are well known [1,2]. The present study is a continuation of the authors' previously reported investigation [3] regarding uranium removal mechanism from aqueous solution. *Citrus limon* peel (exocarp) was chemically treated by 0.25 mol L⁻¹ nitric acid, followed by 0.1 mol L⁻¹ sodium hydroxide and used for removal of U(VI) ions from aqueous solution in a uni-variant general procedure or batch method with the variation of one parameter. Experimental and theoretical studies were conducted to identify the reaction mechanism for U(VI) removal by modified lemon peel under the previously defined optimal parameters (medium pH 8, adsorbent amount 100 mg and contact time 60 min).

The correlation regression coefficients showed that the adsorption process can be well-described by Langmuir equation ($R^2 = 0.963$; $q_{max} = 24.4 \text{ mg g}^{-1}$). Additionally, the pseudo-second order kinetic and Weber-Morris diffusion models were confirmed ($R^2 = 0.999$ and 0.992 , respectively). In general, results of modeling indicated that the binding mechanism of uranium(VI) ions is complex and based on chemisorption, ion exchange and diffusion to the biomaterial.

The results indicated the possible use of lemon peel in a suitable economic, eco-friendly and effective wastewater treatment process. The proposed method could be a promising option for the uranium removal and pollution control.

References

- [1] R. Mehra, S. Singh and K. Singh, *Radiat. Meas.* **42** (2007) 441-445.
- [2] L. Zikovsky, *J. Radioanal. Nucl. Chem.* **267** (2006) 695-697.
- [3] M. Memić, E. Šabanović, M. Nuhanović, *Sixth international scientific conference „June 5th – World environment day“*, The Book of Abstracts, p. 45, 18-19th June 2018, Bihać, B&H.

Determination of arsenic in urine and serum samples with ICP-MS in areas of eastern Croatia

Određivanje koncentracija arsena u uzorcima urina i seruma stanovnika istočne Hrvatske metodom ICP-MS

Vlatka Gvozdić¹, Dinko Puntarić², Marina Vidosavljević³, Matijana Jergović⁴, Dragana Jurić⁵, Miroslav Venus⁶, Lidija Bijelić⁷, Ada Puntarić⁸

¹*Josip Juraj Strossmayer University Osijek, Department of Chemistry, Osijek, Croatia*

²*Universitas Studiorum Catholica Croatia, Zagreb, Croatia*

³*Vinkovci General Hospital, Vinkovci, Croatia*

⁴*Andrija Štampar School of Public Health, School of Medicine, University of Zagreb, Zagreb, Croatia*

⁵*Institute of Public Health, Slavonski Brod, Croatia*

⁶*Institute of Public Health Sv. Rok, Virovitica, Croatia*

⁷*Croatian Health Insurance Fund, Čakovec, Croatia*

⁸*University of Zagreb, Faculty of Science, Biology Department, Environmental Sciences Direction, Zagreb, Croatia*

E-mail: vgvozdic@kemija.unios.hr

Exposure to drinking water contaminated with arsenic is a global environmental problem that affects millions of people in different parts of the world. The groundwater in eastern Croatia has been found to contain very high concentrations of arsenic. Several studies conducted in previous decade have indicated that almost 200,000 people are daily drinking water with arsenic concentrations ranging from 10–610 $\mu\text{g L}^{-1}$ [1,2]. A systematic research of the arsenic concentrations in urine and serum of eastern Croatia populations was never made. Some published papers covered certain segments (water, soil, food, or biological specimens) of a limited geographical area and on a smaller number of samples. The aim of the present study was to evaluate variations in human exposure to arsenic in eastern Croatia based on arsenic concentrations in water, urine and serum samples collected from 505 inhabitants living in eastern Croatia. In this study we selected 391 inhabitants from areas with elevated concentrations in drinking water (Osijek, Našice, Čepin, Vladislavci, Dalj) as well as control population (114) exposed to concentrations of arsenic in drinking water that were below the EU maximum admissible level of 10 $\mu\text{g L}^{-1}$ (Vinkovci, Vukovar, Slavonski Brod). The arsenic concentrations differed significantly (Mann-Whitney test) in the samples of urine and serum ($p=0.036886$; $p=0.036889$) taken from two investigated areas. In urine samples from areas with elevated arsenic concentrations in drinking water, median values were from 19.40 to 73.40 $\mu\text{g L}^{-1}$ [3]. Median values for arsenic in urine and serum samples in Vinkovci, Vukovar and Slavonski Brod area were well below reference values (urine: from 3.8 to 8.5 $\mu\text{g L}^{-1}$; serum from 0.55–0.62 $\mu\text{g L}^{-1}$).

References

- [1] M. Habuda-Stanić, M. Kuleš, B. Kalajdžić and Ž. Romić, *Desalination* **210** (2007) 157–162.
- [2] M. Ćurković, L. Sipos, D. Puntarić, K. Dodig-Ćurković, N. Pivac and K. Kralik, *Pol. J. Environ. Stud.* **25** (2016) 981–992.
- [3] C. Minoia, E. Sabbioni, P. Apostoli, R. Pietra, L. Pozzoli, M. Gallorini, G. Nicolau, I. Alessio and E. Capodaglio, *Sci. Total Environ.* **95** (1990) 89–105.

**Removal of methylene blue dye in aqueous solution by
pretreated eggshells waste**
**Uklanjanje bojila metilenskog modrila iz vodene otopine
predobrađenom ljuskom jajeta**

Ines Cindrić, Jasna Halambek
Veleučilište u Karlovcu, Karlovac, Hrvatska

E-mail: ines.cindric@vuka.hr

Dye wastewater presents high impact to aquatic environment due to its toxicity, non-biodegradability and resistance. Chicken eggshell is one of the abundant inexpensive waste materials which can be applied successfully as a biosorbent for removal of various pollutants. The aim of this study is to investigate the efficiency of differently prepared chicken eggshell for removal of methylene blue dye from aqueous solution.

Batch mode adsorption studies for individual eggshell were performed by determining the efficacy of operating parameters, such as contact time (15 – 120 min), pH (3-12), adsorbent dose (5 – 75 g L⁻¹), initial dye concentration (25 – 100 mg L⁻¹) and type of adsorbent (the raw eggshell, acid activated eggshell, base activated eggshell). Methylene blue dye concentration was estimated spectrophotometrically by monitoring the absorbance at 665 nm using a UV-Vis spectrophotometer.

The results showed that with increasing contact time and adsorbent dose, the dye removal efficiency increased, but with increasing pH and initial dye concentration the removal efficiency decreased. The experimental data were fitted to three rate models and isotherm models. The maximum efficiency for the removal of methylene blue dye was achieved with acid activated eggshell at pH 10, contact time 20 min, adsorbent dose 50 g L⁻¹ and initial dye concentration 25 mg L⁻¹. Adsorption of methylene blue dye ($R^2 = 0.91$) follows the Freundlich isotherm.

The results of this study suggested that the chemically activated eggshells can be effective adsorbent for removal of the methylene blue dye from aqueous solution.

Chemical oxygen demand removal efficiency of oily water emulsion by electrocoagulation

Efikasnost uklanjanja kemijske potrošnje kisika uljno vodenih emulzija procesom elektrokoagulacije

Mirjana Čurlin,¹ Marjana Simonič²

¹*University of Zagreb, Faculty of Food Technology and Biotechnology, Zagreb, Croatia*

²*University of Maribor, Faculty of Chemistry and Chemical Engineering, Maribor, Slovenia*

E-pošta: mcurlin@pbf.hr

Uljno-vodne emulzije kao heterogeni grubo disperzni sustavi sastavni su dio različitih industrijskih procesa u prehrambenoj, farmaceutskoj, kemijskoj i metalo-prerađivačkoj industriji. Karakterizira ih složeni sastav te najčešće sadržavaju ulja (mineralna, biljna ili sintetska), masne kiseline, emulgatore, inhibitore korozije, baktericide i druge tvari. Emulzije koje dopijevaju u okoliš bez prethodne obrade imaju veoma nepovoljan utjecaj na vodeni okoliš, stoga se posebna pozornost treba posvetiti obradi. Procesi elektrokoagulacije uz membransko-filtracijske procese najčešće se upotrebljavaju u obradi uljno-vodenih emulzija. Uspješnost procesa elektrokoagulacije različitih vrsta komercijalnih uljno-vodenih emulzija praćena je preko određivanja kemijske potrošnje kisika (KPK). Rezultati istraživanja pokazuju učinkovitost uklanjanja KPK u rasponu od 57-69 %. Na učinkovitost uklanjanja velik utjecaj imaju pH emulzije, udaljenost između elektroda, jakost struje te čistoća elektroda. Stoga je od osobite važnosti definirati optimalne uvjete provedbe procesa elektrokoagulacije kao i odabir procesa predobrade emulzija koji uvelike utječe na uspješnost provedbe procesa.

**Characterization of polycyclic aromatic hydrocarbons in PM₁₀ and PM_{2.5}
fraction in Zagreb**
**Karakterizacija policikličkih aromatskih ugljikovodika u PM₁₀ i PM_{2,5} frakciji u
Zagrebu**

Zdravka Sever Štrukil, Ivana Jakovljević, Ranka Godec, Gordana Peh nec
Institut za medicinska istraživanja i medicinu rada, Zagreb, Hrvatska

E-pošta: zsever@imi.hr

Policiklički aromatski ugljikovodici (PAU) zajedno s nitro-derivatima čine veliku skupinu od preko 500 poznatih organskih spojeva. Današnja istraživanja usmjerena su na proučavanje PAU-a u zraku vezanih na lebdeće čestice aerodinamičkoga promjera manjega od 10 μm i 2,5 μm (PM₁₀ i PM_{2,5}) s obzirom na dulje zadržavanje takvih čestica u atmosferi, dubljem prodiranju u dišni sustav i posljedično štetnim učincima na zdravlje ljudi. 24-satni uzorci frakcije PM₁₀ i PM_{2,5} sakupljani su na filtrima od kvarcnih vlakana neprekidno 31 dan u siječnju 2017. na dvije lokacije u Zagrebu s različitim utjecajem izvora onečišćenja. Analiza PAU-a provedena je tekućinskom kromatografijom visoke djelotvornosti (HPLC) s fluorescentnim detektorom promjenjivih valnih duljina ekscitacije i emisije. Na gradskoj pozadinskoj postaji u blizini kućanstava (lokacija A) izmjerene su statistički značajno manje masene koncentracije za sve mjerene PAU-e u odnosu na gradsku prometnu postaju (lokacija B). Srednja vrijednost masenih koncentracija deset mjerenih PAU-a u PM₁₀ frakciji iznosila je 42,203 ng m⁻³ na lokaciji A odnosno 86,877 ng m⁻³ na lokaciji B. U PM_{2,5} frakciji izmjerene su ukupne masene koncentracije PAU-a u rasponu 7,000 – 76,166 ng m⁻³ na lokaciji A odnosno od 8,014 ng m⁻³ do 279,377 ng m⁻³ na lokaciji B. Linearnom regresijskom analizom masenih koncentracija PAU-a u PM₁₀ i PM_{2,5} frakciji utvrđeno je da je na lokaciji B više od 82 % mjerenih PAU sadržano u PM_{2,5} česticama u odnosu na PM₁₀. Za lokaciju A je taj odnos još i veći, odnosno dobiveno je da je više od 95 % PAU-a sadržano u manjim česticama (PM_{2,5}), osim za fluoranten i piren za koje je taj postotak bio veći od 62 %. Izračunati dijagnostički omjeri masenih koncentracija pojedinih PAU-a u PM₁₀ i PM_{2,5} frakciji ukazuju na ispušne plinove automobila kao dominantan izvor PAU-a na obje lokacije, te kućna ložišta na lokaciji A. Toksična ekvivalentna koncentracija (TEQ) dobivena zbrajanjem vrijednosti izmjerenih koncentracija pojedinog PAU-a u vanjskom zraku pomnoženih s toksičnim ekvivalentnim faktorom (TEF) pokazala je dvostruko višu vrijednost na lokaciji B (13,784 ng m⁻³) u odnosu na lokaciju A (6,965 ng m⁻³), pri čemu je benzo[a]piren (BaP) sudjelovao s više od 65 % na obje lokacije.

Determination of the atmospheric deposition of polycyclic aromatic hydrocarbons and polychlorinated biphenyls
Određivanje atmosferskog taloženja policikličkih aromatskih ugljikovodika i polikloriranih bifenila

Iva Šimić, Gordana Mendaš Starčević, Gordana Peh nec
Institute for Medical Research and Occupational Health, Zagreb, Croatia

E-mail: isimic@imi.hr

Atmospheric deposition represents an important removal mechanism from the atmosphere to the aquatic and terrestrial systems, and therefore is of great environmental concern. The presence of polycyclic aromatic hydrocarbons (PAHs) and polychlorinated biphenyls (PCBs) in bulk atmospheric deposition (wet and dry) represents a significant portion of waterbody contamination. The PAHs have gained much attention due to their mutagenic and carcinogenic potentials and have therefore been included in the European Union and United States Environmental Protection Agency (EPA) priority pollutant list. PCBs are widespread, highly persistent chemicals with harmful effects on the ecosystem and human health. They are prone to long-range transport by circulation of air masses, deposition on particles to which they are sorbed and wet and dry deposition washing them out from the atmosphere.

The aim of this study was at developing and validating a method for the extraction and determination of 12 PAHs (fluoranthene, pyrene, benz(a)anthracene, chrysene, benzo(b)fluoranthene, benzo(k)fluoranthene, benzo(j)fluoranthene, benzo(a)pyrene, benzo(e)pyrene, indeno(1,2,3-cd)pyrene, dibenz(a,h)anthracene and benzo(g,h,i)perylene) and 6 indicator PCBs congeners (PCB-28, PCB-52, PCB-101, PCB-138, PCB-153 and PCB-180) in deposition samples. The sample preparation was optimized for final analysis by gas chromatography (GC) with electron capture detector (ECD) (for PCBs) and mass spectrometric (MS) detection (for PAHs).

Different solid-phase extraction procedures were investigated and compared by analysing a model deposition sample. The fortified samples with surrogate standard (perylene-d12), PAHs and PCBs in mass concentrations of 0.05 ng ml^{-1} , were forced through a silica solid phase extraction cartridge. To achieve the best extraction procedure efficiency, the elution of retained compounds with different solvents was investigated. The best results were by elution with solvent mixture dichloromethane : *n*-hexane (1:1, v/v). The eluate was dried with anhydrous sodium sulphate, reduced to 2 mL under nitrogen and then analysed by GC-MS/MS and GC-ECD. The mass concentrations of PAHs were determined by internal standard method. The extraction recoveries for PCBs and PAHs were higher than 80% except for BeP, while the recovery of surrogate standard was higher than 50%. The detection limits obtained for PCBs and PAHs were from $0.07 \text{ ng m}^{-2}\text{d}^{-1}$ to $0.33 \text{ ng m}^{-2}\text{d}^{-1}$ and from $0.27 \text{ ng m}^{-2}\text{d}^{-1}$ to $1.44 \text{ ng m}^{-2}\text{d}^{-1}$, respectively.

The method was successfully applied to determine 12 PAHs and 6 PCBs in the bulk atmospheric deposition sampled from an urban background station in Zagreb.

Trend of acidic compounds in total deposited matter in Zagreb air Trend kiselih komponenti u UTT u zagrebačkom zraku

Valentina Gluščić, Gordana Peh nec, Mirjana Čačković, Silva Žužul
Institut za medicinska istraživanja i medicinu rada, Zagreb, Hrvatska

E-pošta: vgluscic@imi.hr

U radu su prikazani rezultati praćenja trendova kiselih komponenti (klorida, nitrata i sulfata) u ukupnoj taložnoj tvari (UTT) u zraku Zagreba u periodu od 2013. do 2017. Mjesečni uzorci UTT sakupljeni su upotrebom Bergerhoffova sakupljača na mjernoj postaji smještenoj u sjevernom rezidencijalnom dijelu grada sa umjerenom gustoćom prometa. Količina UTT određena je gravimetrijski, a analiza sadržaja klorida, nitrata i sulfata u UTT određena je ionskom kromatografijom. U promatranom razdoblju mjerenja, srednje godišnje vrijednosti klorida kretale su se od 0,083 mg/(m²d) do 1,1 mg/(m²d), nitrata od 5,09 mg/(m²d) do 2,35 mg/(m²d), a sulfata od 5,44 mg/(m²d) do 2,03 mg/(m²d). Rezultati pokazuju da razine nitrata u UTT u zraku Zagreba u razdoblju od 2013. do 2017. imaju statistički značajan padajući trend. Razine klorida i sulfata u UTT u zraku Zagreba u promatranom razdoblju također pokazuju padajući trend koji nije statistički značajan.

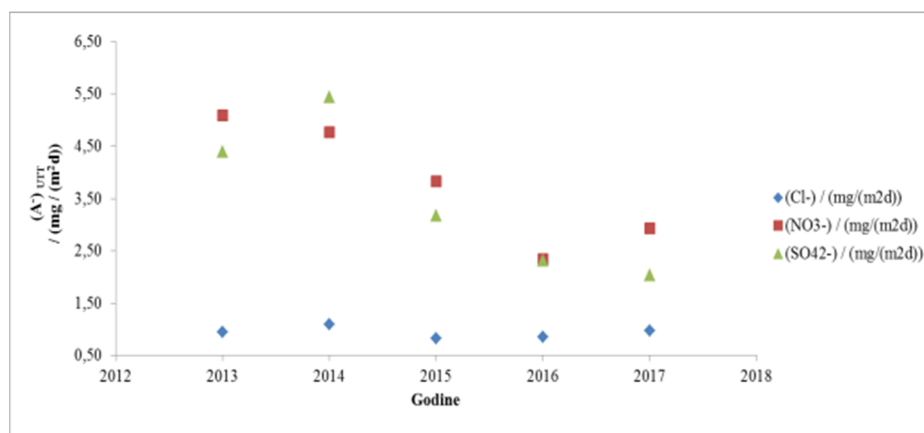

Slika 1: Trend klorida, nitrata i sulfata u ukupnoj taložnoj tvari u zraku Zagreba.

Fractions of airborne particulates in Rijeka, Croatia Frakcije lebdećih čestica u atmosferi grada Rijeke

Ana Alebić-Juretić,¹ Dario Kontošić,² Velimir Zubak²

¹Sveučilište u Rijeci, Medicinski fakultet, Rijeka, Hrvatska

²Nastavni Zavod za javno zdravstvo Primorsko-goranske županije, Rijeka, Hrvatska

E-pošta: ana.alebic.juretic@gmail.com

Kao nastavak MED projekta Poseidon, u okviru kojeg je izučavan utjecaj emisija iz pomorskog prometa na onečišćenje atmosfere u Rijeci [1], istraživanja na Interreg IVA talijansko-hrvatskom projektu EcoMobility, usmjerena su na karakterizaciju 11 frakcija lebdećih čestica sakupljenih kaskadnim impaktorom u razdoblju od 16. 10. do 10. 12. 2018. U tom je razdoblju sakupljeno osam 7-dnevnih uzoraka. U prvom tjednu uzorkovanja sakupljeni su uzorci saharskog pijeska koji su višestruko povećali izmjerene mase, odnosno koncentracija čestica u tom tjednu iznosila je $143 \mu\text{g m}^{-3}$, dok su u ostalim tjednima ti prosjeci bili u rasponu od 9,0 do $29,2 \mu\text{g m}^{-3}$. Raspodjela frakcija lebdećih čestica pokazuje bimodalnu krivulju s maksimumom u frakciji S4 ($3,2 \mu\text{m} > d < 5,6 \mu\text{m}$) i S8 ($0,32 \mu\text{m} > d < 0,56 \mu\text{m}$). Uzorci koji sadrže saharski pijesak ponešto se razlikuju te pored sekundarnog maksimuma u S4 pokazuju i primarni maksimum u S6 ($1 \mu\text{m} > d < 1,8 \mu\text{m}$). Pojava saharskog pijeska povećala je i udio nanočestica ($d < 1 \mu\text{m}$), iako je najveći porast nanočestica rezultat izgaranja u kućnim ložištima.

Reference

[1] E. Merico, A. Gambaro, A. A. Argiriou, A. Alebić-Juretić, E. Barbaro, D. Cesari, L. Chasapidis, S. Dimopoulos, A. Dinoi, A. Donato, C. Giannaros, E. Gregoris, A. F. Kiragiannidis, A. G. Konstandopoulos, T. Ivošević, N. Liora, D. Melas, B. Mifka, I. Orlić, A. Poupkou, K. Šarović, A. Tsakis, R. Giua, T. Pastore, A. Nocioni i D. Contini, *Transp. Res. D* **50** (2017) 431-445.

Monitoring of organic pollutants in wastewater from Čakovec area Praćenje organskih onečišćivala u čakovečkim otpadnim vodama

Tea Borojević, Ivana Mađor-Božinović, Darko Andrić, Danijela Ašperger, Davor Dolar
Fakultet kemijskog inženjerstva i tehnologije, Sveučilište u Zagrebu, Zagreb, Hrvatska

E-pošta: tea0310@gmail.com

Ukupna količina vode na Zemlji ne može se promijeniti i zbog toga vodu treba štedjeti i zaštititi je od onečišćenja. Potrebno je učinkovito upravljati vodnim resursima od izvora, njene potrošnje, kao i upravljanja otpadnim vodama koje, umjesto da se ispuštaju u rijeke ili more i onečišćuju okoliš, treba odgovarajuće obraditi i ponovo koristiti. Obrada komunalne vode s ciljem ponovnog korištenja (oporaba) vrlo je važna kako bi se smanjilo iscrpljivanje podzemnih i površinskih voda namijenjenih piću.

Cilj ovog rada bilo je praćenje organskih onečišćivala u komunalnim otpadnim vodama iz sustava odvodnje i pročišćavanja otpadnih voda aglomeracije Čakovec. Organska onečišćivala imaju različita fizikalno-kemijska svojstva i često zahtijevaju više metoda pripreme uzoraka za analizu, stoga je izazov razviti jednu metodu za njihovo praćenje.

U radu je razvijena nova, jedinstvena metoda pripreme uzoraka otpadne vode ekstrakcijom čvrstom fazom (SPE) na kolonicama Strata-X-33 tvrtke Phenomenex, kojom se istovremeno mogu pripremiti uzorci koji sadrže različite skupine organskih onečišćivala, što dosada nije razvijeno. U ovom radu praćeni su makrolidni antibiotici (azitromicin, eritromicin, klaritromicin), insekticidi (klotianidin, imidaklopid, acetamiprid, tiaklopid, tiametoksam), herbicidi (metiokarb, trialat, oksadiazon) te nesteroidni antireumatici (diklofenak). Nakon pripreme uzoraka oni su, ovisno o fizikalno-kemijskim svojstvima, analizirani dvjema metodama tekućinske kromatografije visoke djelotvornosti spregnute s tandemom spektrometra masa (HPLC-MS/MS). HPLC-MS/MS metode razvijene su u suradnji s Laboratorijem za biomimetričku kemiju Instituta Ruđer Bošković.

Rezultati će se upotrijebiti za daljnja istraživanja s naglaskom na utvrđivanje metaboličkih puteva istraživanih onečišćivala u vodama, kako bi ih se što uspješnije uklonilo iz vode i kako bi se te pročišćene vode mogle iskoristiti za navodnjavanje poljoprivrednih površina, što je i cilj projekta u sklopu kojega je izrađen ovaj rad.

Napomena: Istraživanje se financira u sklopu Programa Vlade Republike Hrvatske za poticanje istraživačkih i razvojnih aktivnosti u području klimatskih promjena za razdoblje od 2015. do 2016. godine, projekt Izravna uporaba komunalne otpadne vode za navodnjavanje membranskim tehnologijama (ReHOHMem).

The impact of the circular economy on the projected capacity of the waste management center Biljane donje
Utjecaj kružnog gospodarstva na projektirani kapacitet centra za gospodarenje otpadom Biljane donje

Dino Perović,¹ Ana Lončarić Božić,² Hrvoje Kušić,² Zlata Hrnjak Murgić²

¹EKO Ltd. Zadar County Waste Management Company, Zadar, Croatia

²Faculty of Chemical Engineering and Technology, University of Zagreb, Zagreb, Croatia

E-mail: dino.perovic@eko-go.hr

The legislative framework for waste management in the Republic of Croatia seeks to establish a higher quality waste management system based on the principle of waste prevention and on an efficient system of separate collection of materials which can be recovered from waste. The waste prevention contributes to accomplishment of the following goals in waste management: i) to decrease the waste quantities, ii) to protect the natural resources, iii) to decrease the total mass of landfilled waste, iv) to minimise the emissions of polluting matters in the environment, v) to decrease the hazard for human health and the environment. Accordingly, Waste management plan of the republic of Croatia for the period 2017 – 2022 set the goals for minimal recycling rates for packaging materials from the waste: 60 % glass, 60 % paper and cardboard, 50 % metals, 22.5 % plastic and 15 % wood.

Croatian Agency for Environment and Nature reports that the total municipal waste produced in 2016, in the area of the planned Waste Management Centre of Biljane Donje, amounted to 120,238 tons or 617 kg *per capita*, which is higher than the EU-28 average (477 kg *per capita* in 2015). Such large quantities of waste production are a consequence of tourism impact on municipal waste generation throughout the year. The share of separately collected recyclable materials from the solid municipal waste in the Zadar county in 2016 was 14%, while in the southern part of the Lika-Senj county was 13%. So, more than 85% of the waste is still landfilled indicating that the satisfying level of separately collected materials is not achieved yet.

In this work, different scenarios of separately collected materials from mixed municipal solid waste (glass, paper, paperboard, metals, plastics and wood) for the Waste Management Center Biljane Donje are elaborated. The scenarios include 20, 30, 40, 50 and 60% separately collected materials and their effect on the operation of the Waste Management Center Biljane Donje, with projected capacity of 75,000 tons of mixed municipal waste and 10,000 tons of biowaste annually.

Degradation of anionic surfactants by the UV-C/H₂O₂ process in of the detergent industry effluents with special emphasis on NaDBS degradation
Razgradnja anionskih tenzida UV-C/H₂O₂ procesom u otpadnim vodama detergentske industrije s posebnim naglaskom na razgradnju NaDBS-a

Zdravka Lovinčić Kraljević, Dubravka Madunić-Čačić
Saponia, Chemical, Pharmaceutical and Foodstuff Industry, Osijek, Croatia

E-mail: dubravka.madunic-cacic@saponia.hr

Advanced oxidation processes (AOPs) have been recognized as a convenient and economical way for treating chemical wastes with persistent organic pollutants [1]. One of such compounds, very important in the group of surfactants, is sodium dodecylbenzene sulphonate (NaDBS). Despite the fact that most of the widely used anionic surfactants (AS) are biodegradable, NaDBS with the widest use of both anionic and all other surfactants is hardly biodegradable.

The purpose of this work was the investigation of the effectiveness of UV-C photo-assisted advanced oxidative process (AOP) with hydrogen peroxide as oxidising agent, on detergent industry effluents containing NaDBS concentrations over the legally permitted one.

In investigation we used results obtained on model systems, especially investigations about optimum NaDBS:H₂O₂ ratio at different initial NaDBS concentrations (50-1000 ppm) [2].

All experiments were performed in the glass batch reactor ($V = 750$ mL), with low-pressure mercury lamp as the source of UV irradiation (UV-C = 254 nm) placed vertically in the middle of the reactor. The ultimate goal of investigation was to create a prediction model of optimal conditions for the degradation of anionic surfactants, following the changes of effluent composition in its entirety as wide as possible.

Before the treatment, samples of effluents were analysed (anionic, cationic and non-ionic surfactants) to estimate the required amount of oxidising agent. The results of decomposition were monitored by potentiometric titrations [3] using a highly-sensitive surfactant-selective electrode for AS [4]. Results obtained for AS were compared with those obtained by standard method for AS determination in wastewaters (MBAS).

References

- [1] M. A. Oturan and J.-J. Aaron, *Crit. Rev. Environ. Sci. Technol.* **44** (2014) 2577-2641.
- [2] D. Madunić-Čačić, Z. Lovinčić Kraljević, A. Lončarić Božić, D. Juretić and M. Sak-Bosnar, 15th Ružička Days, Vukovar 2014.
- [3] M. Sak-Bosnar, D. Madunić-Čačić, Z. Grabarić and B. S. Grabarić, in *The Sava River*, R. Milačić, Radmila, J. Scancar and M. Paunović (Eds.), *The Handbook of Environmental Chemistry 31*, Springer-Verlag Berlin Heidelberg, 2015, pp. 157-176.
- [4] D. Madunić-Čačić, M. Sak-Bosnar, R. Matešić-Puač and Z. Grabarić, *Sensor Lett.* **6** (2008) 339-346; D. Madunić-Čačić, M. Sak-Bosnar, M. Samardžić and Z. Grabarić, *Sensor Lett.* **7** (2009) 50-56.

**POSTERSKA PRIOPĆENJA
OBRAZOVANJE**

***POSTER PRESENTATIONS
EDUCATION***

Ivy for you – I wish a tree Bršljan za tebe – želim stablo

Marijana Magdić, Valentina Ćosić

Osnovna škola Sesevetska sela, Sesevete, Zagreb, Hrvatska

E-pošta: marijana.magdic.ma@gmail.com

Projekt „Bršljan za tebe“ osmišljen je tako da učenike osnovnih škola potakne na svestranije promišljanje o povezivanju nastavnih sadržaja pojedinih predmeta, na uporabu informacijsko-komunikacijske tehnologije (IKT) [2] u svakodnevnom životu te na razvijanje poduzetničkih vještina. Kroz projekt se željelo povezati učenike razredne i predmetne nastave, potaknuti kreativnost sudionika te razvijati timski rad i suradničko učenje.

U projektu su sudjelovali učenici razredne nastave 1. i 2. razreda te učenici predmetne nastave 5., 6., 7. i 8. razreda OŠ Sesevetska Sela u Zagrebu.

Projekt se sastojao od sljedećih etapa:

1. Sadnja i praćenje rasta biljke bršljana [2],
2. Analiza i obrada podataka [1],
3. Istraživanje ljekovitih svojstava bršljana,
4. Izrada bajke i slikovnice „Bajka o bršljanu“,
5. Priprema predstave,
6. Izrada macerata od bršljana,
7. Oglašavanje i promocija.

U prvoj etapi projekta učenici 1. i 5. razreda zasadili su sadnice bršljana. Dvije sadnice bršljana spojene su senzorima na programabilno mikroračunalo *Micro:bit* te su imale kontroliranu vlažnost tla i programirano redovito zaljevanje [2]. Ostalim sadnicama bršljana mijenjani su osnovni životni uvjeti, svjetlost, temperatura, voda, tlo. Sadnice su podijeljene u skupine i svakoj skupini sadnica mijenjan je samo po jedan parametar dok su ostali bili konstantni. Pratio se rast i promjene na biljkama. Izmjereni podatci bilježeni su u tablice za praćenje. Dobiveni rezultati prikazani su tablično i grafički. Na temelju dobivenih rezultata zaključivalo se kako promjena pojedinog parametra utječe na rast i razvoj biljaka.

Istraživanjem različitih sadržaja na internetu učenici su pronašli korisne informacije o ljekovitosti, štetnosti kao i mitologiji vezanoj uz bršljan. Učenici su izrađivali slikovnice i bajke s temom bršljana. Maslinovo ulje i usitnjeni listovi bršljana upotrebljeni su u proizvodnji macerata od bršljana. Tijekom projekta uspješno je ostvarena međupredmetna korelacija i interdisciplinarnost [1,2] na sljedećim predmetima i područjima: priroda, kemija, biologija, hrvatski jezik, likovna kultura, priroda i društvo, engleski jezik, informatika, te tehnička kultura.

Reference

[1] M. Sikirica, *Zbirka kemijskih pokusa za osnovnu i srednju školu*, Školska knjiga, 2011, Zagreb.

[2] N. Hajdinjak, *Primjeri integracije microbita u nastavu s različitim međupredmetnim sadržajima* (priručnik za učitelje), Profil Klett, 2017, Zagreb.

Influence of potassium nitrate toxicity on the Malaysian dwarf snail Utjecaj toksičnosti kalijeva nitrata na malezijskog svrdlastog puža

Magdalena Lugarić, Petra Marija Rajković, Marija Tankosić (učenice)

Mirjana Krpan (mentor)

Ženska opća gimnazija Družbe sestara milosrdnica, Zagreb, Republika Hrvatska

E-pošta: krpanmirjana@gmail.com

Istraživanjem se pokušalo dati odgovor na pitanje može li toksikant kalijev nitrat svojom prisutnošću u vodenim staništima ugroziti opstanak malezijskog svrdlastog puža. Pretpostavka je da će u otopini s najvećom koncentracijom nitrata (90 mg L^{-1}) biti najmanji broj mrijestova, veličina puževih kućica najmanja, a smrtnost najveća. Kod puževa u otopini gdje je koncentracija nitrata 60 mg L^{-1} pretpostavka je da će smrtnost i broj mrijestova biti manji, a veća veličina puževih kućica. U otopini gdje ima najmanje nitrata (30 mg L^{-1}) očekuju se najmanje promjene [1-3]. Za svaku pojedinu koncentraciju otopine toksikanta postavljeno je pet laboratorijskih čaša volumena 1,5 L od kojih su tri sadržavale po 1 L otopine toksikanta odgovarajuće koncentracije, a preostale dvije bile su kontrolne, s po 1 L obične vode. U svaku od pet čaša dodano je deset puževa podjednake početne veličine između 8 do 12,5 mm. Tijekom trajanja testa (6 tjedana) temperatura medija u čašama kretala se u rasponu od 16 do 20 °C, pH vode od 7 do 8, a količina otopljenog kisika od 5,0 do 7,4 mg L^{-1} . Praćenjem ponašanja testnih puževa u ispitivanim koncentracijama kalijeva nitrata nisu zapažene nikakve posebne promjene u usporedbi s puževima u kontrolnim čašama. Prosječan broj mrijestova u testnim čašama s najnižom koncentracijom nitrata je 1,3 puta manji u odnosu na kontrolne čaše s običnom vodom, u otopini koncentracije 60 mg L^{-1} taj je broj 1,4 puta manji, a u otopini koncentracije 90 mg L^{-1} čak 2,2 puta manji. U kontrolnim otopinama smrtnosti puževa nije bilo, dok je u otopinama koncentracija 60 mg L^{-1} i 90 mg L^{-1} smrtnost iznosila 3,3 %.

U istraživanju je dokazano da se ispitivani puž može prilagoditi na povišene koncentracije nitratnih iona u vodi pod uvjetom da ispitivana koncentracija nije tolika da izazove veliku smrtnost ili potpuni prestanak mriještenja životinja. Istraživanje je provedeno u obliku praktične nastave učenika kojom se potiče učenje otkrivanjem i istraživanjem i kojom se ističe potreba za očuvanjem okoliša.

Reference

- [1] L. Dvoraček i B. Stilinović, *Hrvatska vodoprivreda* **69** (1998) 60-67.
- [2] R. Erben i J. Lajtner, *Hrvatska vodoprivreda* **28** (1995) 30-32.
- [3] G. I. V. Klobučar i J. Lajtner, *Hrvatska vodoprivreda* **50** (1996) 50-54.

RADIONICE

WORKSHOPS

**Publishing your chemical sciences research with the Royal Society of
Chemistry**
**Objaviti istraživanje iz područja kemijskih znanosti u časopisima izdavača
Royal Society of Chemistry**

Andrew J. T. Shore

Royal Society of Chemistry, Cambridge, United Kingdom

E-mail: shorea@rsc.org

Andrew Shore is the Executive Editor of RSC Advances. This workshop will present an overview of how to get your chemical sciences research published with the Royal Society of Chemistry and other scientific journals. It will include tips from the Editor to enhance the impact of your article, explain the reviewing process and your responsibilities as a reviewer, an overview of the publication process at the Royal Society of Chemistry and best practise concerning ethical publishing.

Which way to go? Kojim putem krenuti?

Ines Topalović, Mislav Matić, Irena Milardović, Marina Bekavac, Leo Bolješić, Ema Podravski,
Leonarda Vugrin, Karla Ribičić
Fakultet kemijskog inženjerstva i tehnologije, Zagreb, Hrvatska (Studentska sekcija HDKI-ja)

E-pošta: studenti@hdki.hr

Kada je netko na početku znanstvene karijere, najvažnije mu je spoznati kojim područjem bi se htio baviti, a onda pronaći dobrog mentora koji će ga u to područje uvesti i što više ga naučiti. Na pitanje tko je dobar mentor moglo bi se dati mnogo odgovora i teško bi bilo ne ostati subjektivan, no svi se slažu oko jednoga – dobar mentor je motivacija. Njegov često trnovit put, njegova karijera, njegovo iskustvo i znanje, njegov entuzijazam prema onome što radi najveća su motivacija onome koji je na početku puta, koji tek treba stvarati i djelovati. Hrvatska je bogata velikim znanstvenicima, velikim mentorima, posebice u području kemije i kemijskog inženjerstva. Kojim su putem oni išli, na koje su prepreke nailazili i kako su uspjeli? Na sva ta pitanja odgovara radionica Studentske sekcije HDKI-ja pod nazivom „Kojim putem krenuti?“. Osim toga, svima onima koji su na početku svojega puta može pomoći u odluci kojim putem oni trebaju krenuti i kakvog mentora izabrati.



Slika 1: Sve započinje idejom.

SciFinderⁿ – the choice for chemistry and life science research
SciFinderⁿ – izbor za istraživanje iz područja kemije te bioloških i biotehničkih znanosti

Tetiana Khristova

ACS International Ltd, Chemical Abstracts Service (CAS), Columbus, Ohio, United States

E-mail: tkhristova@acs-i.org

Our research shows that scientists have to spend a lot of time perfecting queries and reviewing results. With SciFinderⁿ you will get valuable, high-quality information in a new easy-to-use interface, but more importantly you will get real insights from fellow scientists at CAS and time saved.

CAS scientists thoroughly analyze the literature indexed in SciFinderⁿ so you can quickly search the authoritative CAS databases for substances, reactions, and patent and journal references, giving you confidence you aren't missing important results.

- Powerful, easy-to-use interface that helps you at every step
- Reduces result set review time with significant advances in query search relevancy
- Intuitive search features that allow you to quickly find the most relevant answers to your research questions
- Helps you stay current in your field by easily creating alerts for timely updates on the latest research

SciFinderⁿ is designed by and for scientists like you to enhance your discovery efforts every step of the way. SciFinderⁿ will get you on your way and back to the bench faster than any other solution.

Public speaking for chemists – the good, the bad, and the *ugly* Javni nastup za kemičare – dobar, loš i *gadan*

Vladimir Stilinović, Dominik Cinčić

Sveučilište u Zagrebu, Prirodoslovno-matematički fakultet, Kemijski odsjek, Zagreb, Hrvatska

E-pošta: vstilinovic@chem.pmf.hr

Jedan od često zanemarenih aspekata obrazovanja u prirodnim znanostima je komuniciranje znanosti (kako pismeno tako i usmeno) ne samo drugim znanstvenicima, već i širim, laičkim, krugovima. Ova će se radionica pozabaviti jednim od aspekata usmene komunikacije – javnim nastupom; što čini neko predavanje dobrim ili lošim, na što valja obratiti pozornost prilikom pripreme i izvedbe predavanja te koje su česte pogreške. Analizirajući tipične pogreške, pokušat ćemo razviti osjećaj za kvalitetu predavanja. Jer, mada je teško definirati pojam 'kvalitete', svatko će je lako prepoznati kada se s njome susretne [1].

Reference

[1] R. M. Pirsig, *Zen and the Art of Motorcycle Maintenance*, William Morrow & Co., New York, 1974.

PARALELNE RADIONICE SEKCIJE OBRAZOVANJE

PARALLEL WORKSHOPS OF THE EDUCATION SECTION

How to write a chemistry problem (workshop) Kako napisati zadatak iz kemije (radionica)

Tajana Preočanin,¹ Sanja Žužek,² Sonja Rupčić Petelinc,² Helena Peter Jelenčić³

¹Kemijski odsjek, Prirodoslovno-matematički fakultet, Zagreb, Hrvatska

²Prirodoslovna škola Vladimira Preloga, Zagreb, Hrvatska

³XVIII. gimnazija, Zagreb, Hrvatska

E-pošta: tajana@chem.pmf.hr, sanja.zuzek2@gmail.com, sonja.rupcic@gmail.com, peter-jelencic@skole.hr

Pisanje i priprema zadataka iz kemije vještina je koja se temelji na dobrom poznavanju kemijskih koncepata i preciznom određivanju svrhe postavljanja pojedinog zadatka. S kemijskim konceptima *Tvari*, *Promjene i procesi* te *Energija* [1] učenici se tijekom nastave Kemije upoznaju postepeno, a uvođenje svakog novog pojma nadograđuje se na prethodno usvojene. Sve kemijske koncepte prožima prirodoslovna pismenost koja se razvija kroz vještine objektivnog opažanja i mjerenja, obrade rezultata, analize i prezentacije rezultata. Pri sastavljanju zadataka treba imati na umu što se učenika želi ispitati i u koju svrhu [2]. Rješavanje zadataka može imati svrhu učvršćivanja prirodoslovne pismenosti, povezivanja pojedinih kemijskih koncepata, stavljanja kemije u kontekst primjene, ali u konačnici i provjeravanja usvojenog znanja i vještina na različitim razinama.

Izrada kvalitetnog zadatka složen je proces. Svaki zadatak ima određenu težinu i kognitivnu razinu. Zadatkom se može ispitati jedan ishod (zadatci višestrukog izbora) ili više ishoda (zadatci otvorenoga tipa). Zadatak može biti i problemski na način da se ponudi kratki scenarij kojim se definira kontekst zadatka, a potom se ispituju različiti ishodi temeljem početnog sadržaja. Zadatci kojima se ispituje više ishoda mogu se sastojati od više čestica od kojih svaka čestica ispituje jedan ishod ili se mogu sastojati od jedne čestice unutar koje se rješava zadatak od više koraka od kojih svaki korak ispituje jedan ishod (politomni zadatci). Pri izradi zadataka treba se voditi općim načelima za oblikovanje zadataka [3]. Pri pisanju potrebno je koristiti dogovorenu nomenklaturu kemijskih spojeva, simbole i mjerne jedinice [4,5]. Posebnu je pažnju potrebno posvetiti izradi grafičkih prikaza, slika i tablica.

Na ovoj radionici predstaviti će se izrada zadataka otvorenog tipa temeljem početnog zadanog scenarija. Pokazat će se kako jedan polazni sadržaj može biti temelj za ispitivanje različitih ishoda i kemijskih koncepata, te otvara mogućnosti za izradu različitih zadataka ovisno o razini i namjeni zadatka.

Reference

[1] Prijedlog predmetnog kurikuluma Kemija, Ministarstvo znanosti i obrazovanja, studeni 2018.

[2] Ispitni katalog za državnu maturu u školskoj godini 2018./2019. Kemija, Nacionalni centar za vanjsko vrednovanje obrazovanja, Zagreb, 2018.

[3] Priručnik za stručne radne skupine koje izrađuju ispite državne mature s primjerima zadataka iz ispita na državnoj maturi, Nacionalni centar za vanjsko vrednovanje obrazovanja, Zagreb, 2017.

[4] T. Cvitaš, N. Kallay, *Fizikalne veličine i jedinice Međunarodnoga sustava (SI)*, Hrvatsko kemijsko društvo, Zagreb, 1975.

[5] T. Cvitaš, I. Planinić i N. Kallay, *Rješavanje računskih zadataka u kemiji I. dio*, Hrvatsko kemijsko društvo, Zagreb, 2008.

Chemistry education adjusted to each student – Gardner’s theory Nastava kemije za svakog učenika – Gardnerova teorija

Nikolina Penić,^{1,2} Draginja Mrvoš-Sermek²

¹Prva privatna gimnazija, Zagreb, Hrvatska

²Kemijski odsjek, Prirodoslovno-matematički fakultet, Sveučilište u Zagrebu, Zagreb, Hrvatska

E-pošta: npenic@ppg.hr

Za razumijevanje temeljnog kemijskog pojma *valencija* potrebna su mnoga predznanja koja se uče i usvajaju tek na višoj obrazovnoj razini. Stoga je osnovnoškolskom nastavniku, u početnom poučavanju kemije, pravi izazov učenicima *valenciju* objasniti i približiti. Neprimjeren pristup može biti izvor pogrešnih shvaćanja odnosno znanstveno neutemeljena osnova za daljnje kemijsko obrazovanje. Ova je hipoteza ispitana na odabranoj studentskoj populaciji, a rezultati su pokazali da čak niti višegodišnje kemijsko obrazovanje nema utjecaja na mijenjanje poimanja pogrešno usvojenih pojmova [1]. Nije potrebno naglasiti da je pojam *valencije* još teže objasniti i približiti djeci s posebnim obrazovnim potrebama.

U sklopu ove radionice dan je prijedlog za unapređenje nastavne prakse u osnovnoj školi pri poučavanju pojma *valencija* temeljen na: (a) strategiji učenja otkrivanjem, (b) Gardnerovoj teoriji višestrukih inteligencija [2] i (c) Bloomovoj taksonomiji s ciljem prilagodbe djeci s posebnim obrazovnim poteškoćama [3]. Prijedlog nastavnog sata je nekonvencionalan te izborom postupaka i nastavnih metoda nema uzora u standardnoj metodologiji poučavanja navedenog pojma. Pokušalo se poticati lingvističko-verbalnu i vizualno-prostornu inteligenciju i ujedno omogućiti provedbu istraživački usmjerene i kreativne nastave s naglaskom na individualnost, talente i poteškoće. U sklopu prijedloga nastavnog sata dizajniran je višenamjenski trodimenzionalni periodni sustav elemenata kao model i didaktičko pomagalo za slijepce i slabovidne učenike „Vitez Čovek“, a nastavni sadržaji usvajaju se kroz stih [1].

„O ŠAROLIKOSTI SVIJETA“

*Naime postoji jedno SVOJSTVO ATOMA koje se naziva VALENCIJA,
nadam se da vam oko nje neće biti potrebna nikakva intervencija.*

Koliko je elektrona nekog atoma uključeno u vezanje s drugim atomima

VALENCIJA nam kaže,

te se na temelju toga KEMIJSKA FORMULA nekog spoja lako ISKAŽE.

Kako i na koji način su ti elektroni u cijelu priču uključeni,

za tu priču ćemo u prvom srednje biti poučeni.

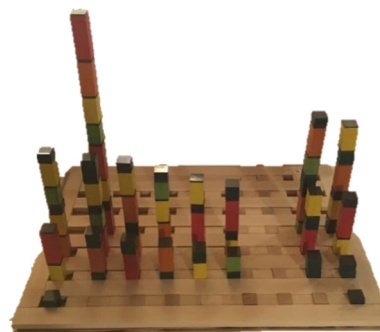

Reference

- [1] N. Penić, *Valencija – temeljni kemijski pojam*, Diplomski rad (metodički dio, mentor D. Mrvoš-Sermek), Prirodoslovno-matematički fakultet, Sveučilište u Zagrebu, Zagreb, 2018.
- [2] H. Gardner, *Multiple Intelligences; The Theory in Practice*, Basic Books, New York, 1993.
- [3] R. D. Davis i E. M. Braun, *Dar disleksije*, Alinea, Zagreb, 2001.

Soaps and detergents – green chemistry in teaching Sapuni i detergents – zelena kemija u nastavi

Nenad Židak,^{1,2} Draginja Mrvoš-Sermek²

¹Osnovna škola Josipa Zorića, Dugo Selo, Hrvatska

²Kemijski odsjek, Prirodoslovno-matematički fakultet, Sveučilište u Zagrebu, Zagreb, Hrvatska

E-pošta: nzidak@chem.pmf.hr

Izvođenje kemijskih pokusa dio je iskustvenoga učenja i temeljna aktivnost u nastavi kemije, a zahtijeva uključenost kognitivnih procesa opažanja, sporazumijevanja i rasuđivanja.

U radionici *Sapuni i detergents – zelena kemija u nastavi*, osmišljenoj prema uzoru na rad Seta Senga i suradnikā [1], predstavljen je prijedlog pripreme nastavnoga sata za četvrte razrede gimnazija i strukovnih škola s detaljno razrađenim radnim listićem za učenike i uputom za izradu jednostavnog fotometra (slika 1) [1,2]. Pokus se temelji na fotometrijskom određivanju masenog udjela tenzida natrijeva dodecil-sulfata u otopinama uporabom kationske boje gencijana violet i anionske briljantno plave. Umjesto organskih otapala, za ekstrakciju se koristi akrilno platno koje se svojim svojstvima uklapa u načela zelene kemije [3].

Tijekom provedbe pokusa učenika se potiče na razvijanje čitalačke pismenosti, nadogradnju temeljnih kemijskih pojmova i koncepata, preciznosti u mjerenju, razvijanje vještine prikazivanja i tumačenja rezultata i razlikovanje kemijskih metoda za određivanje nepoznatih koncentracija tvari u otopini [2].

Potencijal ove metode jest u ostvarenju korelacija s ishodima sadržaja više nastavnih predmeta: 1. tehnička kultura, izraditi jednostavni fotometar; 2. fizika, okarakterizirati reflektanciju, apsorbanciju i transmitanciju te svojstva i principe rada instrumenta; 3. kemija, razviti analitičku metodu kombinacijom različitih kemikalija, boja, detergenata i tkanina; 4. biologija, mjeriti analitičkom metodom abiotičke ekološke čimbenike vodenih ekosustava; 5. informatika, unaprijediti instrument hardverskom i softverskom digitalizacijom. Ovakav integrirani pristup poučavanju i navedene međupredmetne korelacije mogu biti osnova za koncipiranje učeničkog istraživačkog projekta.

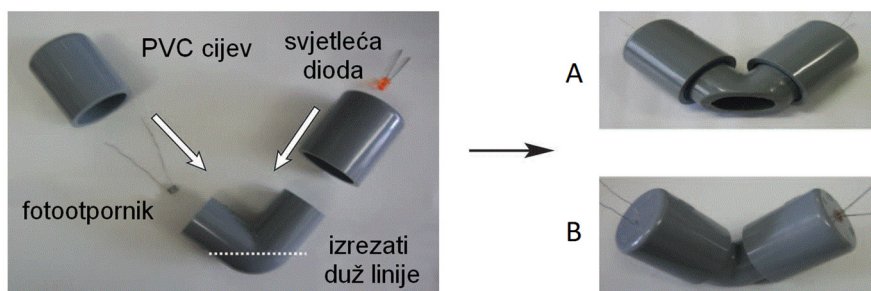

Slika 1: Dijelovi za izradu jednostavnog fotometra te prikaz (A) odozdo i (B) odozgo [1.]

Reference

- [1] S. Seng, M. Kita i R. Sugihara, *J. Chem. Educ.* **84** (2007) 1803-1805.
- [2] N. Židak, *Sapuni i detergents*, Diplomski rad (metodički dio, mentor D. Mrvoš-Sermek), Prirodoslovno-matematički fakultet, Sveučilište u Zagrebu, Zagreb, 2014.
- [3] N. Židak i N. Osmanagić Bedenik, *The Challenge of Green Chemistry*, <https://www.bib.irb.hr/939645>; posjećeno 7. 1. 2019.



ALPHACHROM



Agilent

Authorized
Distributor

Science WITH CONFIDENCE

Honeywell

PICARRO

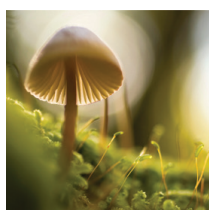
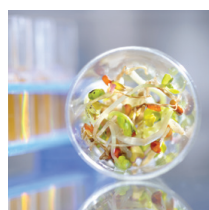

- Liquid Chromatography
- Gas Chromatography
- Mass Spectrometry – Q, QQQ, Q-TOF
- In Vitro Diagnostics kits for LC, LCMS, GC, GCMS
- Atomic spectroscopy – AAS, ICP-OES, MP-AES, ICP-MS, ICP-MSMS
- Molecular spectroscopy – FTIR, UV/Vis/NIR, Fluorescence, FTIR imaging
- Stable isotope analyzers and gas quantification
- Dissolution
- Consumables and supplies
- Laboratory chemicals
- Life science – PCR, Microarray, electrophoresis, microplate readers, Hi-content imaging
- Education/training programs
- Service & support
- Partner company ASOLUTIC – lab water, microwave technology & mercury analyzers, TOC/TN flow analysis, thermal analysis, autoclaves, climate chambers, laboratory equipment & furniture etc.



ASOLUTIC

AlphaChrom d.o.o. Karlovačka cesta 24, 10000 Zagreb

T 01 550 2200 | F 01 550 2299 | E prodaja@alphachrom.hr | www.alphachrom.hr

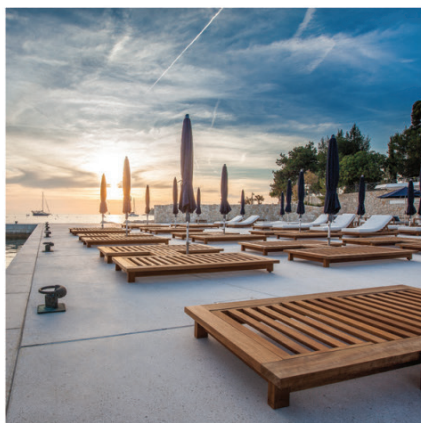
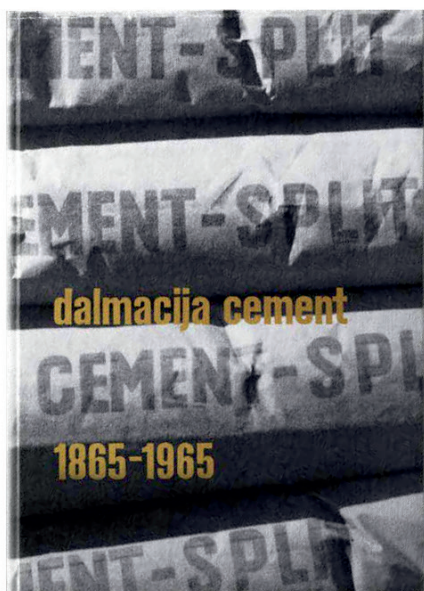

**tradicija
snaga
kvaliteta**



Daleke 1965. godine obilježili smo stogodišnjicu proizvodnje cementa u Dalmaciji predstavljanjem projekata koji su obilježili prostor oko nas, a kojih ne bi bilo bez naših proizvoda.
Danas je dovoljno reći: **Dalmacijacement.**





SciFinderⁿ Get actionable results faster

Do exponentially more with SciFinderⁿ.

Accelerate discovery in your organization. Give your researchers streamlined access to highly relevant, actionable information that will propel your research program forward faster with confidence.

- Relevant results right away.
- Includes easy access to full-text, indexed patents, and millions of step-by-step syntheses indexed specifically by CAS.
- Powerful, easy-to-use interface that helps you at every step.

To get the benefits of SciFinderⁿ now talk to your CAS sales representative, or you can learn more at www.cas.org/scifinder-n



SCIFINDERⁿ
A CAS SOLUTION



CENTRALNI ISPITNI LABORATORIJ

Mjesto znanja i kvalitete!

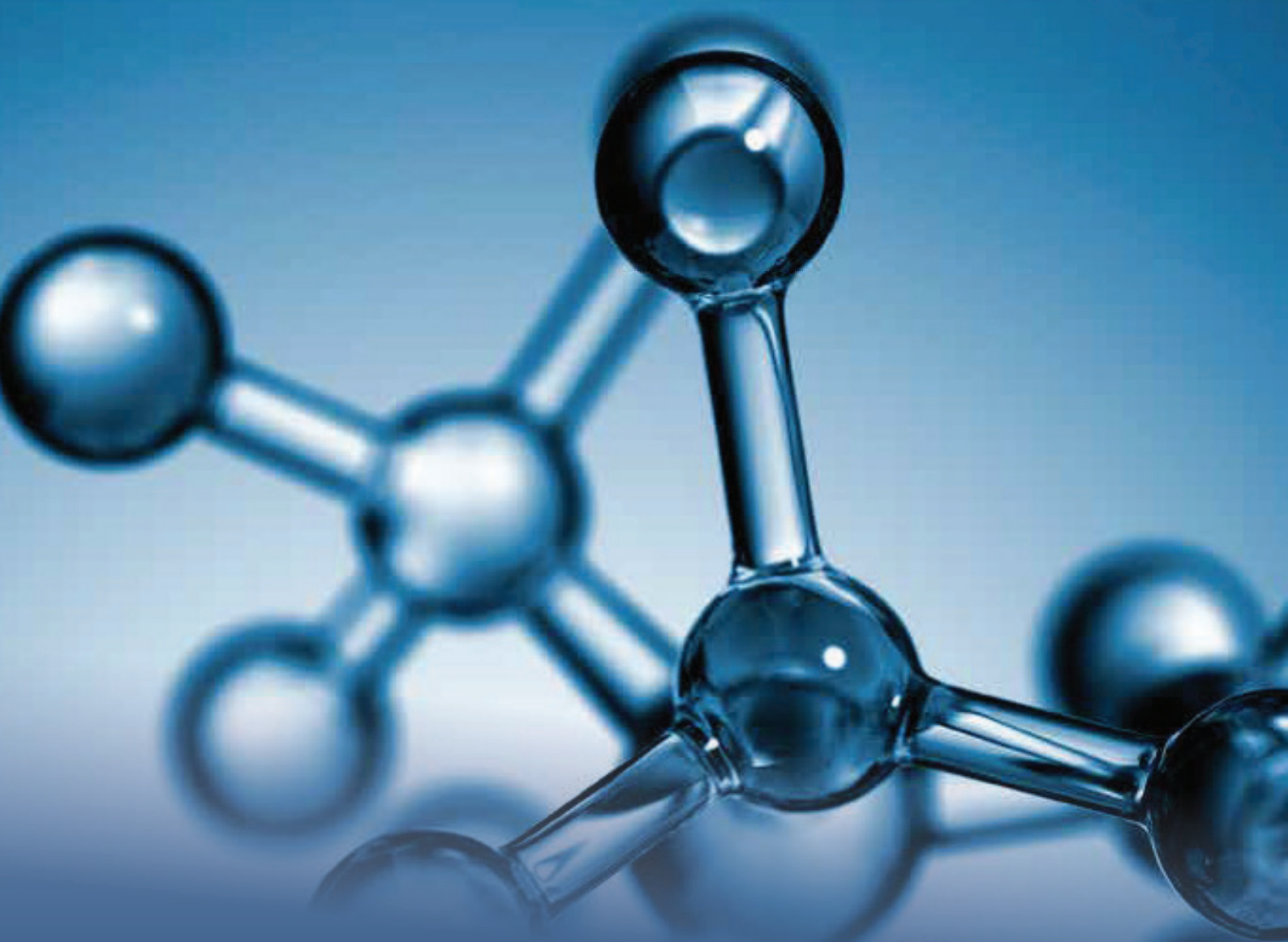

Adresa
Lovinčićeva 4
10002 Zagreb





TA Instruments je vodeći proizvođač instrumenata za toplinsku analizu (TGA, DSC, DMA, TMA), reometara i mikrokolorimetara koji se koriste za karakterizaciju različitih materijala; od polimera i lijekova do eksploziva i mikroorganizama.



Waters

THE SCIENCE OF WHAT'S POSSIBLE.®

Waters je već više od 60 godina lider i najveći inovator na području kromatografije (HPLC, UPLC, SFC) i spektrometrije masa. Waters instrumenti se upotrebljavaju u laboratorijima diljem svijeta za mjerenje kemijskih, fizikalnih i bioloških svojstava materijala u farmaceutskoj i kemijskoj industriji, za ispitivanje hrane, u istraživačkim ustanovama te institutima i fakultetima.



The First Name In Materials Testing

Tinius Olsen je specijalizirani proizvođač uređaja za ispitivanje statičkih mehaničkih svojstava materijala, kao što su: vlačna čvrstoća, kompresija, tvrdoća (Brinell, Vickers, Rockwell), žilavost (Charpy) i mnoge druge karakteristike.



Labtim pruža kompletni spektar prilagođenih rješenja našim parterima, kombinirajući snažnu lokalnu servisnu podršku s aplikativnom podrškom i iskusnim prodajnim stručnjacima.

Labtim Adria d.o.o.

Jaruščica 7/A, 10020 Zagreb, Hrvatska

Tel: + 385 (0)1 6623 883 , Fax: +385 (0)1 6623 884

info@labtim.hr | www.labtim.hr





Već generacijama
znanje vraćamo
zajednici.



TEVA

PLIVA



xellia

Xellia Pharmaceuticals is a leading developer, manufacturer and supplier of life-saving anti-infectives. With over 100 years of industry experience in developing last resort treatments for infectious diseases, Xellia is focused on the supply of products which not only save lives, but also improve and enhance patients' quality of life. We are a specialty pharmaceutical company focused on fermented antibiotics and injectable finished products. Headquartered in Copenhagen, Denmark, and owned by Novo A/S, we are more than 1700 employees globally. From state-of-the-art manufacturing sites in the U.S, China, Denmark and Hungary to R&D sites in Norway and Croatia; Xellia Pharmaceuticals excels within innovative product development to deliver high quality products.



xellia.com



xellia
PHARMACEUTICALS

www.xellia.com

IZDAVAČ | *Published by*

Hrvatsko društvo kemijskih inženjera i tehnologa | Zagreb, 2019.
ISBN: 978-953-6894-67-3